

RoHS  **SMOV34S Varistor Series**

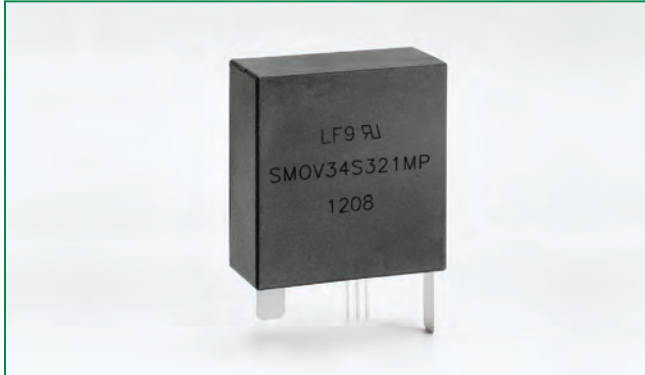

**Agency Approvals**

Agency	Agency File Number
	E320116

**Description**

The Littelfuse SMOV thermally protected varistor is a self-protected device. It consists of a 34mm square varistor with an integral thermal disconnect designed to open in the event of overheating due to abnormal overvoltage as outlined in UL1449 3rd edition. The SMOV helps facilitate SPD module compliance to UL1449 and offers quick thermal response due to the close proximity of the integrated thermal element to the MOV body. This configuration also offers lower inductance than most discreet solutions resulting in improved clamping performance to fast over voltage transients.

The device has a separate micro-switch, which can be used to indicate that the MOV has been disconnected from the circuit. This separate switch makes the monitoring circuitry completely isolated from the main power which ensures indicator circuit safety and simplifies the customers circuit design.

**Features**

- Maximum single surge capability 40 kA, 8/20 waveshape.
- Nominal Discharge Current Value: 20kA.
- Intermediate current rating: 50A/150A.
- -45°C to +75°C operating temperature.
- Recognized to UL 1449 3rd edition.
- Lead-Free and RoHS compliant.
- Integrated micro-switch for indication circuitry/design.

**Applications**

- SPD applications
- AC/DC distribution
- IT/Data center
- Power supplier
- Telecommunication

SMOV34S Series

### Absolute Maximum Ratings

• For ratings of individual members of a series, see Device Ratings and Specifications chart

	SMOV34S Series	Units
<b>Continuous:</b>		
<b>Steady State Applied Voltage:</b>		
DC Voltage Range (VM(DC))	150 to 970	V
AC Voltage Range (VM(AC)RMS)	115 to 750	V
<b>Transient:</b>		
Non-Repetitive Surge Current, 8/20µs Waveform (ITM)	40,000	A
Non-Repetitive Energy Capability, 2ms Waveform (W <sub>TM</sub> )	280 to 1200	J
Operating Ambient Temperature Range (TA)	-45 to +75	°C
Storage Temperature Range (T <sub>STG</sub> )	-45 to +85	°C
Hi-Pot Encapsulation (Isolation Voltage Capability)	2500	V
Isolation Voltage Capability (when the thermal disconnect opens)	1500	V
Housing Insulation Resistance	>1,000	MΩ

CAUTION: Stresses above those listed in "Absolute Maximum Ratings" may cause permanent damage to the device. This is a stress only rating and operation of the device at these or any other conditions above those indicated in the operational sections of this specification is not implied.

### SMOV34S Series Ratings & Specifications

Part Number	Maximum Rating (75°C)					Specifications (25 °C)				
	Continuous		Transient			Varistor Voltage at 1mA Test Current		Maximum Clamping Voltage 8/20µs		Typical Capacitance f = 1MHz
	AC Volts	DC Volts	Energy 2ms	Peak Surge Current 8/20µs	Nominal Discharge Current					
	VM(AC)RMS (V)	VM(DC) (V)	W <sub>TM</sub> (J)	ITM 1 x Pulse (A)	In (A)	V <sub>N(DC) Min</sub> (V)	V <sub>N(DC) Max</sub> (V)	Vc (V)	IFK (A)	C (pF)
SMOV34S111MP	115	150	280	40000	20000	163	202	305	200	11500
SMOV34S131MP	130	175	310	40000	20000	184	228	345	200	10000
SMOV34S151MP	150	200	360	40000	20000	212	268	405	200	8000
SMOV34S181MP	180	240	400	40000	20000	254	312	488	200	6800
SMOV34S251MP	250	320	490	40000	20000	354	429	650	200	5000
SMOV34S271MP	275	350	550	40000	20000	389	473	730	200	4500
SMOV34S301MP	300	385	590	40000	20000	433	528	780	200	4050
SMOV34S321MP	320	420	640	40000	20000	462	561	830	200	3800
SMOV34S421MP	420	560	910	40000	20000	610	748	1130	200	3000
SMOV34S461MP	460	610	960	40000	10000	642	783	1188	200	2800
SMOV34S511MP	510	675	960	40000	10000	735	910	1350	200	2500
SMOV34S551MP	550	700	965	40000	10000	770	939	1415	200	2250
SMOV34S751MP	750	970	1200	40000	10000	1080	1320	2000	200	1800

Average power dissipation of transients should not exceed 2.0 watts

Same ratings and specifications apply to Non Isolated Monitored Switch alternative design. Replace "M" with "N" in the part number. e.g.: SMOV34S111NP. Refer to Part Number System at the end of this document.

**Thermal Characteristics**

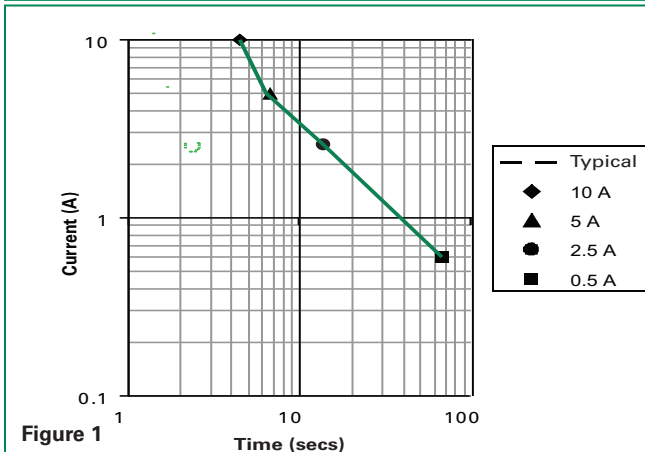

**Peak Current & Energy Derating Curve**

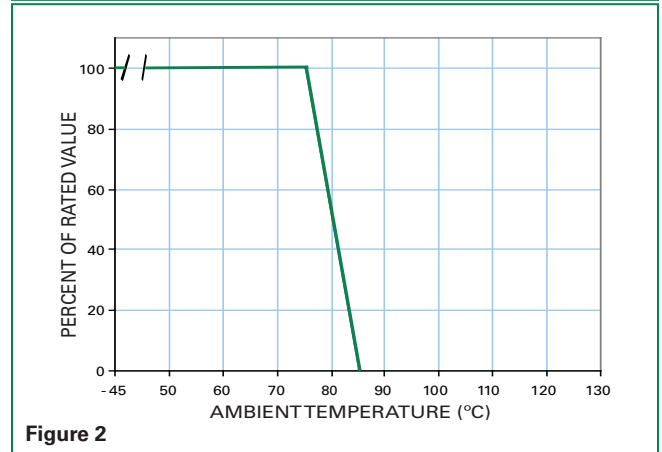

For applications exceeding 75°C ambient temperature, the peak surge current and energy ratings must be reduced as shown.

**Pulse Rating Curve**

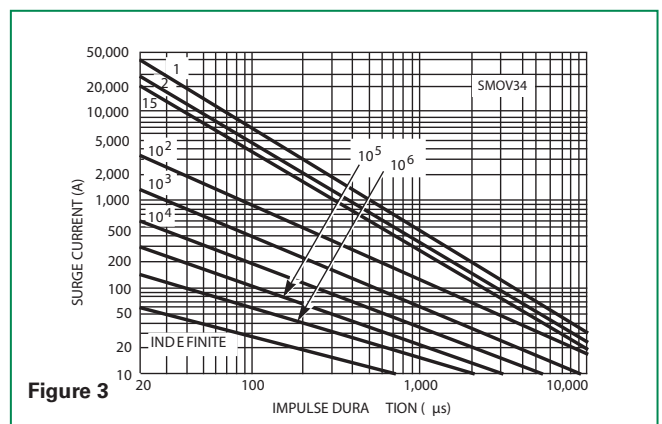

**SMOV34S V-I Characteristic Curves for SMOV34S Varistor**

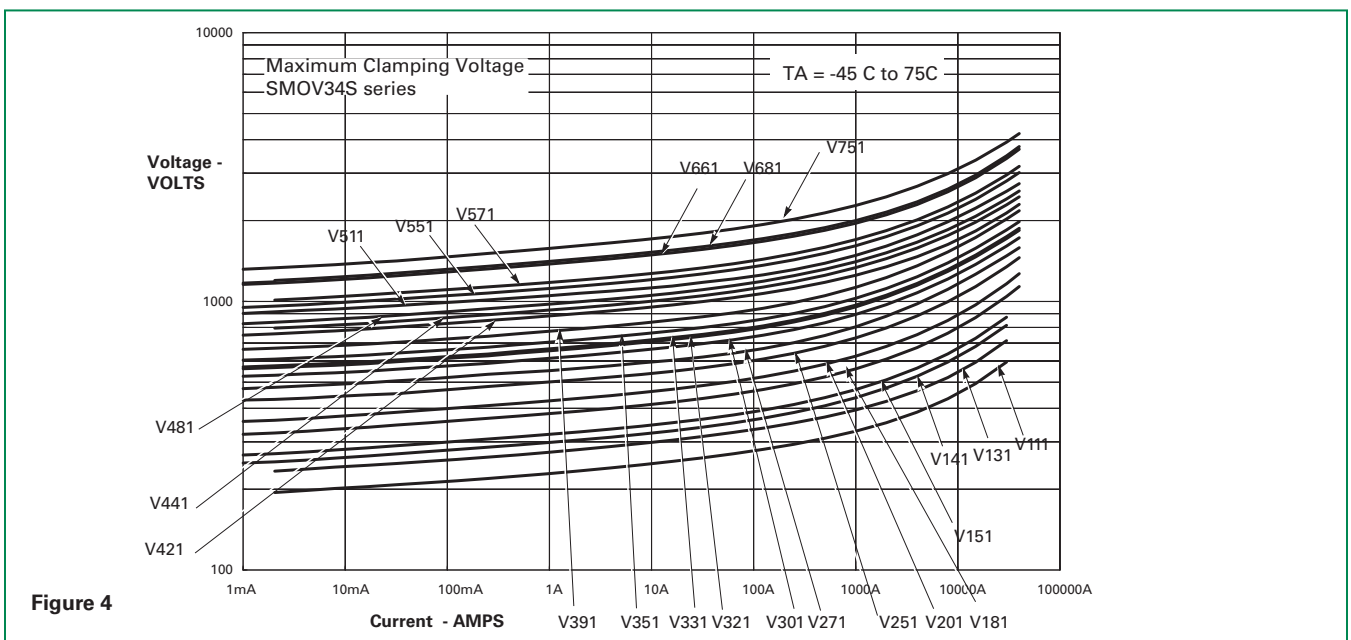

### Wave Solder Profile

Because the SMOV34S Series varistors contain a thermal protection device, care must be taken when soldering the devices into place. Two soldering methods are possible. Firstly, hand soldering:

It is recommended to heat-sink the leads of the device. Secondly, wave-soldering: It is critically important that all preheat stage and the solder bath temperatures are rigidly controlled.

### Non Lead-free Profile

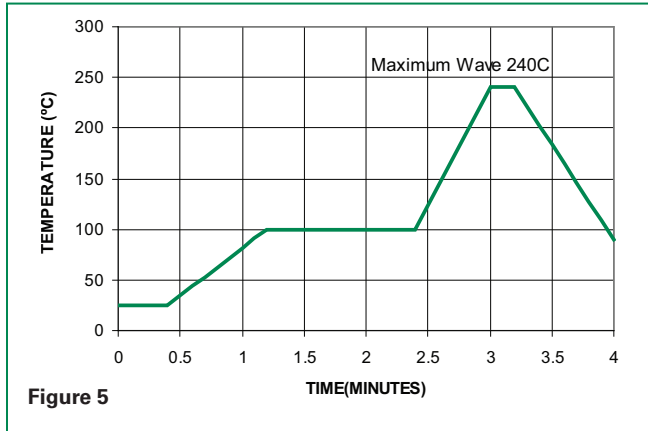

### Lead-free Profile

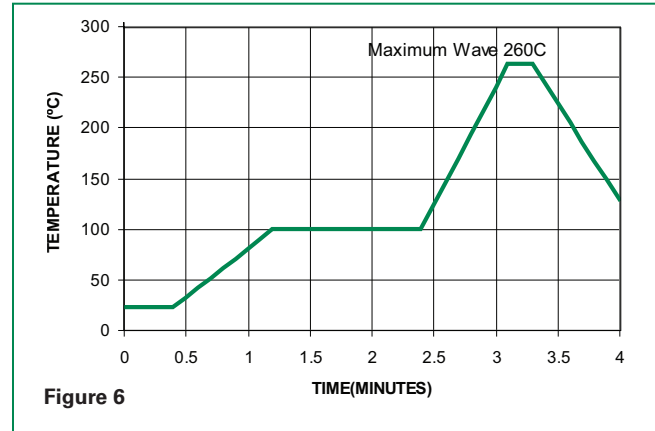

### Physical Specifications

<b>Lead Material</b>	Tin-plated Copper
<b>Soldering Characteristics</b>	Solderability per MIL-STD-202, Method 208E
<b>Insulating Material</b>	Cured, flame retardant epoxy polymer meets UL94V-0 requirements.
<b>Device Labeling</b>	Marked with LF, part identifier, and date code

### Environmental Specifications

<b>Operating/Storage Temperature</b>	-45°C to +75°C/ -45°C to +85°C
<b>Humidity Aging</b>	+75°C, 85% RH, 1000 hours +/-10% voltage
<b>Thermal Shock</b>	+75°C to -40°C 5 times +/-10% voltage
<b>Solvent Resistance</b>	MIL-STD-202, Method 215F
<b>Moisture Sensitivity</b>	Level 1, J-STD-020C

### Part Numbering System

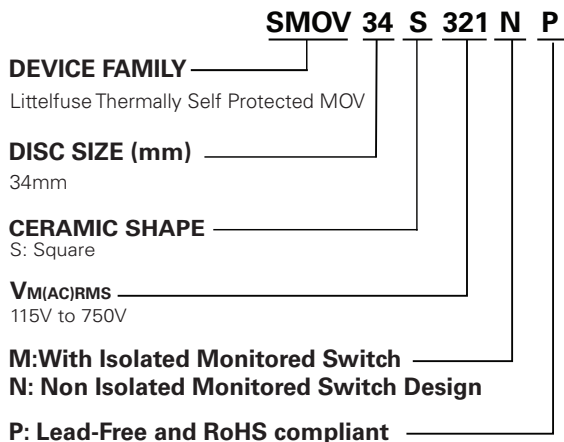

### Part Marking System

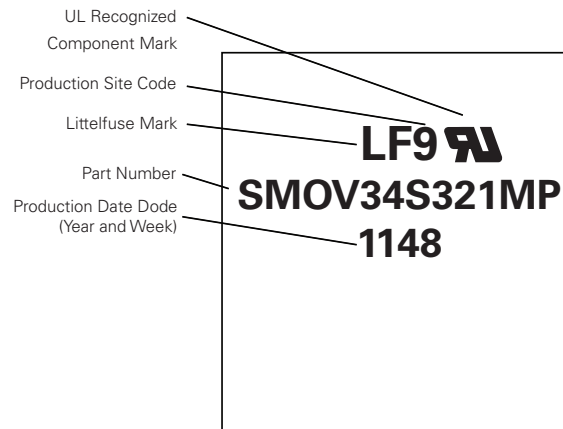

**Device Dimension**

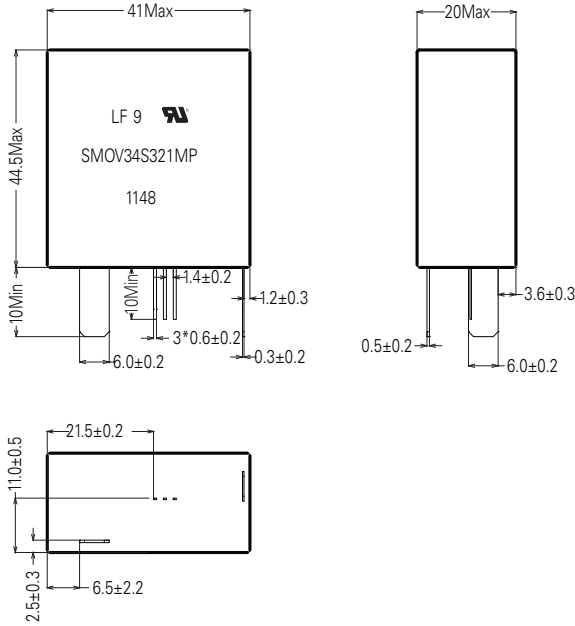

**Lead Configuration**

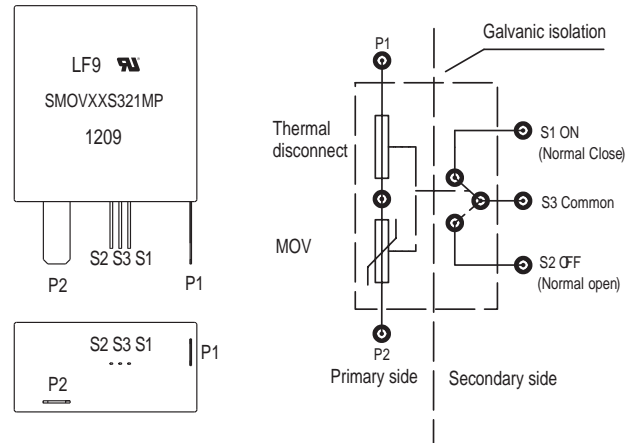

**SMOV34S Series**

**Application Example**

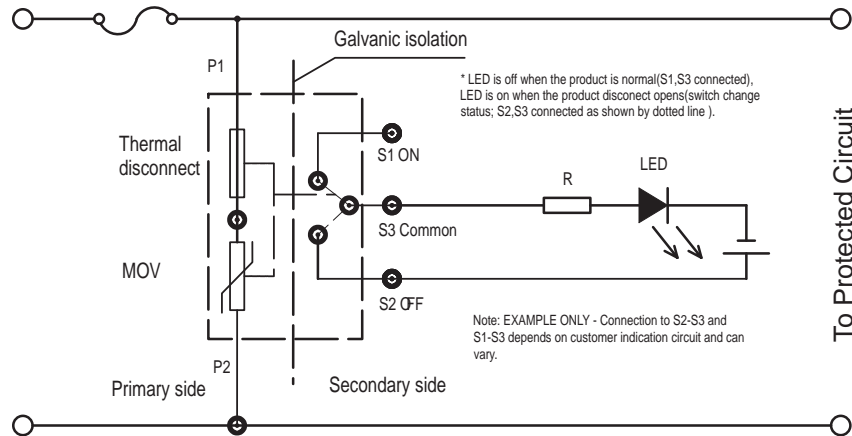

**Switch Specification**

SMOV Switch	Voltage DC	Current (Amps)	Contact Resistance Max.	Insulation Resistance Min.	Dielectric Strength 0.5mA/Minute
Switch	12V	0.1A	70mΩ	100MΩ	500VAC

## Term Definitions

### Rated AC Voltage ( $V_{M(AC)RMS}$ ) – MCOV

This is the maximum continuous sinusoidal RMS voltage that may be applied. This voltage may be applied at any temperature up to the maximum operating temperature of the device.

### Maximum Non-Repetitive Surge Current ( $I_{TM}$ )

This is the maximum peak current which may be applied for a single 8/20 $\mu$ s impulse, with rated line voltage also applied, without causing device failure. The pulse can be applied to the device in either polarity with the same confidence factor.

### Nominal Discharge Current ( $I_N$ )

Peak value of the current, selected by the manufacturer, through the SPD having a current waveshape of 8/20 $\mu$ s where the SPD remains functional after 15 surges.

### Voltage Protection Rating ( $V_{PR}$ )

A rating selected from a list of preferred values as given in UL 1449 and assigned to each mode of protection. The value of VPR is determined as the nearest highest value taken from UL 1449 to the measured limiting voltage determined during the transient-voltage surge suppression test using the combination wave generator at a setting of 6kV, 3kA.

### UL 1449

An Underwriters Laboratory standard covering the safety requirements for Surge Protective Devices intended for permanently connected, cord-connected and direct plug-in applications.

### Limited Current Abnormal Over-voltage Test

An AC over-voltage condition applied to a Surge Protective Device according to UL 1449, Section 39.4. The short circuit current is limited by series connected resistors to 10A, 5A, 2.5A, 0.5A and 0.125A. The condition is maintained for 7 hours or until the device under test is disconnected from the AC supply or the current or temperature reaches equilibrium.

### Maximum Non-Repetitive Surge Energy ( $W_{TM}$ )

This is the maximum rated transient energy which may be dissipated for a single current pulse at a specified impulse duration, with the rated RMS voltage applied, without causing device failure.

### Nominal Voltage ( $V_{N(DC)}$ )

This is the voltage at which the device changes from the off (standby state) to the on (clamping state) and enters its conduction mode of operation. The voltage value is usually characterised at the 1mA point and has a specified minimum and maximum voltage range.