

Fully Integrated Battery Charger with Two Step-Down Converters

General Description

The RT9511 is a fully integrated low cost solution with a single-cell Li-Ion battery charger and two high efficiency step-down DC/DC converters ideal for portable applications.

The Battery Charger is capable of being powered up from AC adapter and USB (Universal Serial Bus) port inputs which can automatically detect and select the AC adapter and the USB port as the power source for the charger. The Battery Charger enters sleep mode when both supplies are removed. The Battery Charger optimizes the charging task by using a control algorithm including preconditioning mode, fast charge mode and constant voltage mode. The charging task is terminated as the charge current drops below the preset threshold. The USB charge current can be selected from preset ratings 100mA and 500mA, while the AC adapter charge current can be programmed up to 1A with an external resistor. The internal thermal feedback circuitry regulates the die temperature to optimize the charge rate for all ambient temperatures. The Battery Charger features 18V and 7V maximum rating voltages for AC adapter and USB port inputs respectively. The other features are external programmed safety timer, under voltage protection, over voltage protection for AC adapter supply, battery temperature monitoring and charge status indicator.

The high-efficiency step-down DC/DC converter is capable of delivering 1A output current over a wide input voltage range from 2.5V to 5.5V, the step-down DC/DC converter is ideally suited for portable electronic devices that are powered from 1-cell Li-ion battery or from other power sources such as cellular phones, PDAs and hand-held devices. Two operating modes are available including : PWM/Low-Dropout autoswitch and shut-down modes. The Internal synchronous rectifier with low $R_{DS(ON)}$ dramatically reduces conduction loss at PWM mode. No external Schottky diode is required in practical application.

The RT9511 is available in a WQFN -24L 4x4 package.

Features

- **Battery Charger**
 - ▶ **Automatic Input Supplies Selection**
 - ▶ **18V Maximum Rating for AC Adapter**
 - ▶ **Integrated Selectable 100mA and 500mA USB Charge Current**
 - ▶ **Internal Integrated Power FETs**
 - ▶ **Charge Status Indicator**
 - ▶ **External Capacitor Programmable Safety Timer**
 - ▶ **Under Voltage Protection**
 - ▶ **Over Voltage Protection**
 - ▶ **Automatic Recharge Feature**
 - ▶ **Battery Temperature Monitoring**
 - ▶ **Thermal Feedback Optimizing Charge Rate**
 - ▶ **Power Path Controller**
- **Step-Down DC/DC Converter**
 - ▶ **Adjustable Output from 0.6V to VIN**
 - ▶ **1A Output Current**
 - ▶ **95% Efficiency**
 - ▶ **No Schottky Diode Required**
 - ▶ **1.5MHz Fixed-Frequency PWM Operation**
- **Small 24-Lead WQFN Package**
- **RoHS Compliant and Halogen Free**

Applications

- MP3/MP4 Player
- GPS
- Digital Photo Frame
- Hand held Device

Marking Information

For marking information, contact our sales representative directly or through a Richtek distributor located in your area.

Ordering Information

- RT9511□□
- Package Type
QW : WQFN-24L 4x4 (W-Type)
 - Lead Plating System
G : Green (Halogen Free and Pb Free)

Note :

Richtek products are :

- } RoHS compliant and compatible with the current requirements of IPC/JEDEC J-STD-020.
- } Suitable for use in SnPb or Pb-free soldering processes.

Pin Configurations

(TOP VIEW)

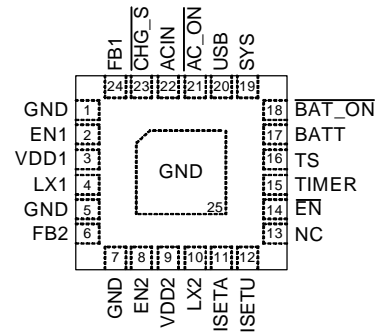

WQFN-24L 4x4

Typical Application Circuit

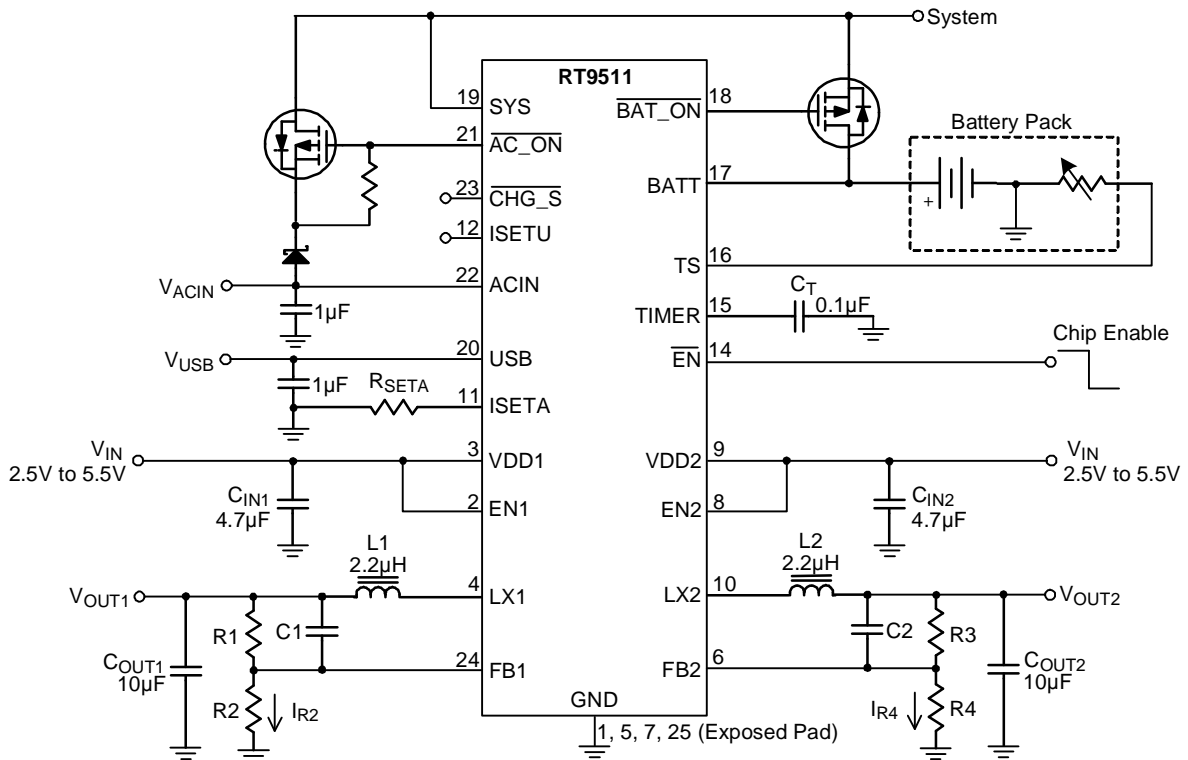

Functional Pin Description

Pin No.	Pin Name	Pin Function
1, 5, 7, 17 (Exposed Pad)	GND	The exposed pad must be soldered to a large PCB and connected to GND for maximum power dissipation.
2	EN1	Chip Enable Input Pin of Buck Converter 1. (Active High)
3	VDD1	Power Input Pin of Buck Converter 1.
4	LX1	Switching Output Pin of Buck Converter 1.
6	FB2	Feedback Voltage Input Pin of Buck Converter 2.
8	EN2	Chip Enable Input Pin of Buck Converter 2. (Active High)
9	VDD2	Power Input Pin of Buck Converter 2.
10	LX2	Switching Output Pin of Buck Converter 2.
11	ISETA	Adaptor Supply Charge Current Set Point.
12	ISETU	USB Supply Charge Current Set Input.
13	NC	No Internal Connection.
14	$\overline{\text{EN}}$	Charge Enable Input Pin of Charger. (Active Low)
15	TIMER	Safe Charge Timer Setting.
16	TS	Temperature Sense Input.
17	BATT	Battery Charge Current Output.
18	$\overline{\text{BAT_ON}}$	Power path controller output. This pin is used to turn on an external P-MOSFET.
19	SYS	System Voltage Detector Input Pin.
20	USB	USB Supply Voltage Input Pin.
21	$\overline{\text{AC_ON}}$	P-MOSFET Switch Control Output (open drain).
22	ACIN	Adaptor Supply Voltage Input Pin.
23	$\overline{\text{CHG_S}}$	Charge Status Indicator Output. (Open Drain)
24	FB1	Feedback Voltage Input Pin of Buck Converter 1.

Function Block Diagram

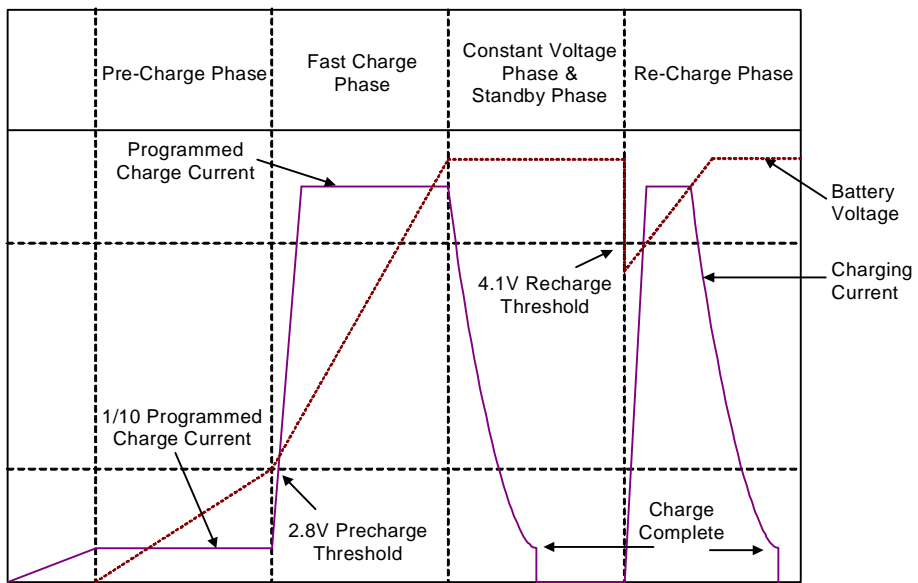
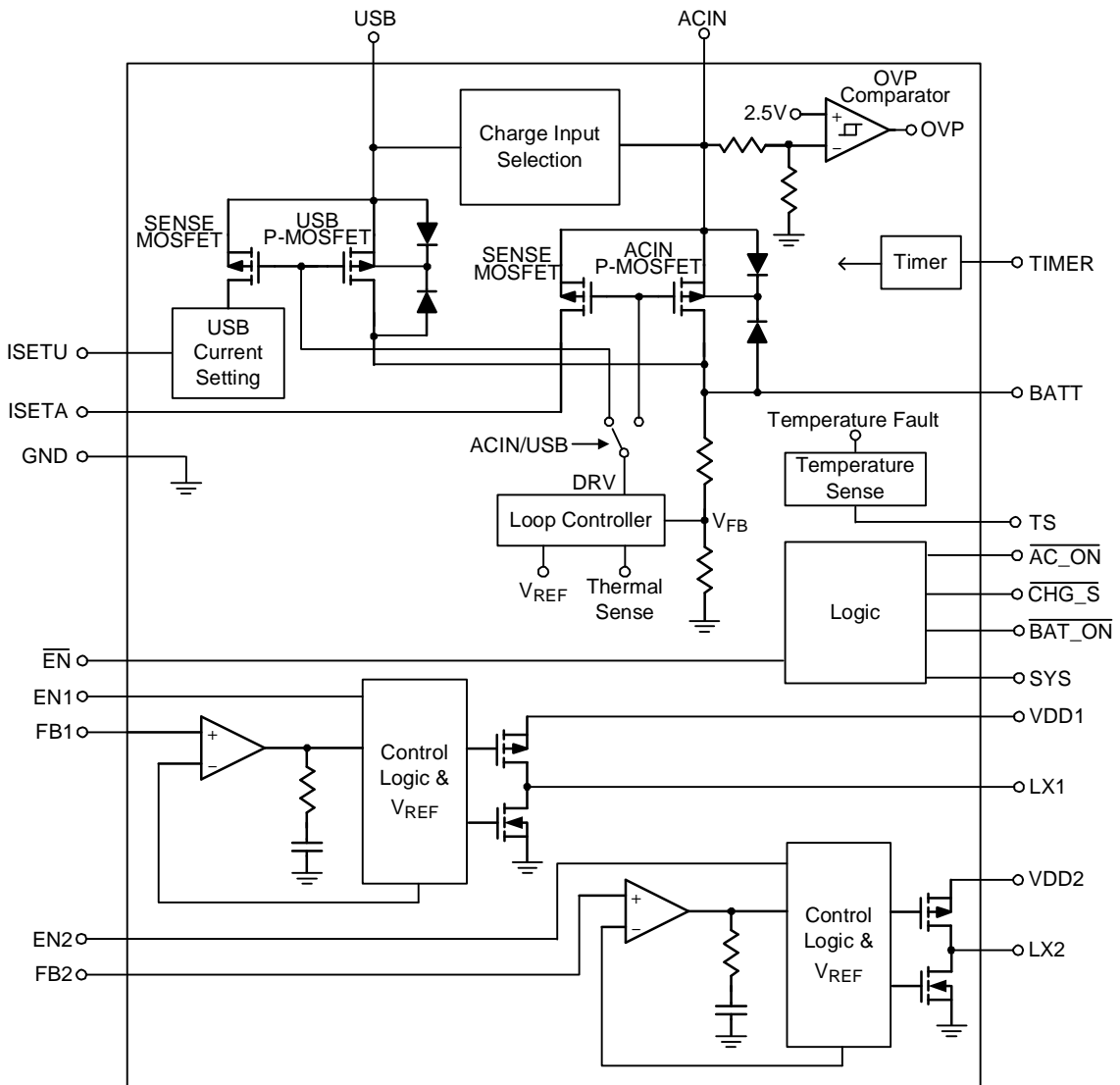
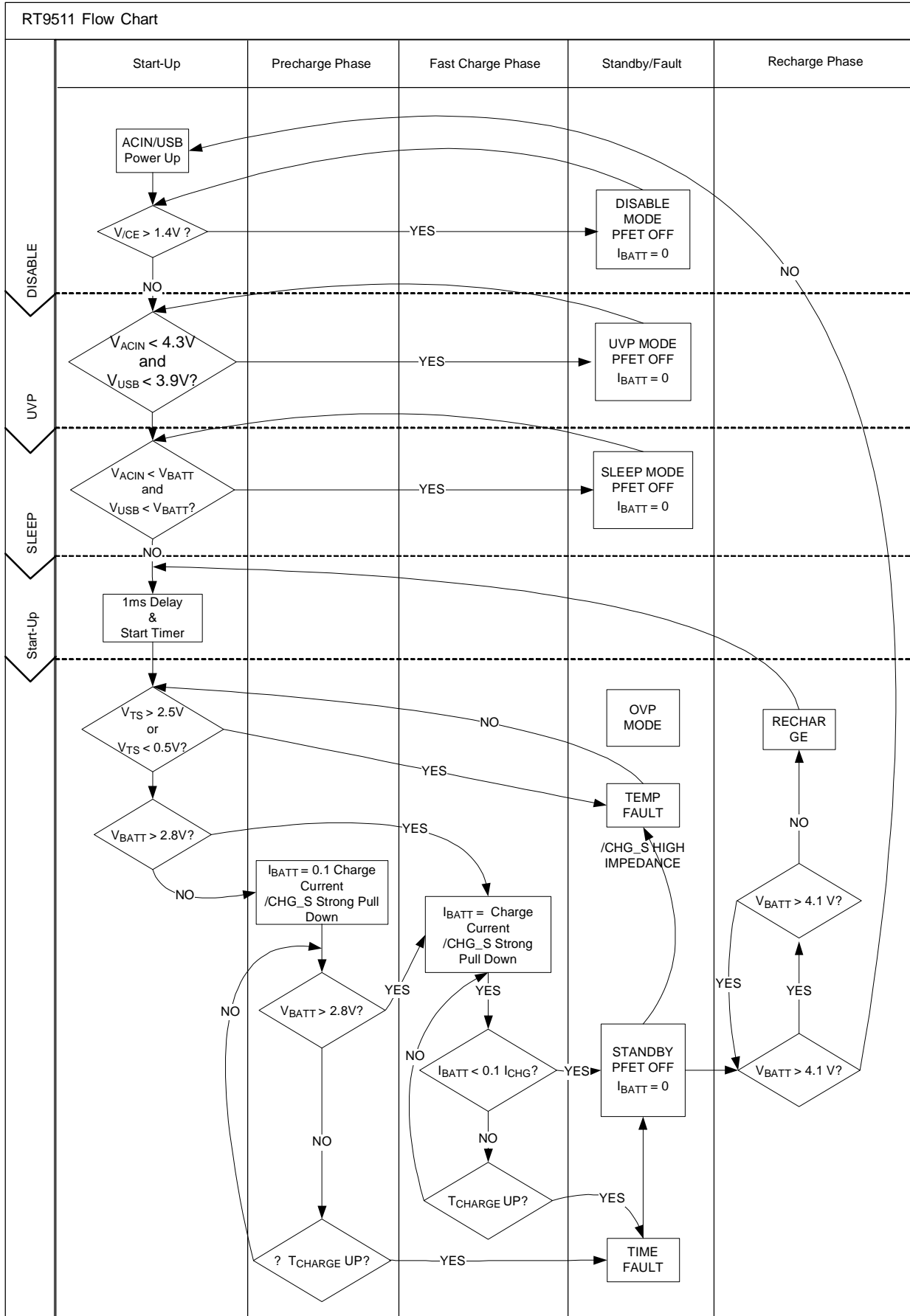

Figure 1 . Charging I-V Curve



Absolute Maximum Ratings (Note 1)

Supply Input Voltage, ACIN -----	-0.3V to 18V
Supply Input Voltage, USB -----	-0.3V to 7V
Supply Input Voltage, EN1, EN2, FB1, FB2 -----	-0.3V to 6V
VDD1, VDD2 -----	6.5V
Power Dissipation, P _D @ T _A = 25°C	
WQFN-24L 4x4 -----	1.923W
Package Thermal Resistance (Note 2)	
WQFN-24L 4x4, θ _{JA} -----	52°C/W
WQFN-24L 4x4, θ _{JC} -----	7°C/W
Lead Temperature (Soldering, 10 sec.) -----	260°C
Junction Temperature -----	150°C
Storage Temperature Range -----	-65°C to 150°C
ESD Susceptibility (Note 3)	
HBM (Human Body Mode) -----	2kV
MM (Machine Mode) -----	200V

Recommended Operating Conditions (Note 4)

Supply Input Voltage Range, ACIN -----	4.5V to 12V
Supply Input Voltage Range, USB -----	4.1V to 6V
Supply Input Voltage Range, VDD1, VDD2 -----	2.5V to 5.5V
Junction Temperature Range -----	-25°C to 125°C
Ambient Temperature Range -----	-25°C to 85°C

Electrical Characteristics

(V_{ACIN} = V_{USB} = 5V, T_A = 25°C, unless otherwise specification)

Parameter	Symbol	Test Conditions	Min	Typ	Max	Unit
Supply Input						
ACIN UVP Threshold Voltage	V _{UV_ACIN}	Rising	4.1	4.3	4.5	V
USB UVP Threshold Voltage	V _{UV_USB}	V _{BATT} = 3V, Rising	3.7	3.9	4.1	V
ACIN/USB UVP Hysteresis	V _{UV_HYS}	V _{BATT} = 3V	40	100	140	mV
ACIN/USB Standby Current	I _{STBY}	V _{BATT} = 4.5V	--	300	500	μA
ACIN/USB Shutdown Current	I _{SHDN}	V _{EN} = High	--	50	100	μA
BATT Sleep Leakage Current	I _{SLEEP}	V _{ACIN} = 4V, V _{USB} = 4V, V _{BATT} = 4.5V	--	5	15	μA
Voltage Regulation						
BATT Regulation Voltage	V _{REG}	I _{BATT} = 60mA	4.158	4.2	4.242	V
ACIN MOSFET Dropout		V _{BATT} = 4V, I _{CHG} = 1A	400	500	620	mV
USB MOSFET Dropout		V _{BATT} = 4V, I _{SET_USB} = High	500	650	800	mV
Current Regulation						
ISETA Set Voltage (Fast Charge Phase)	V _{ISETA_FCHG}	V _{BATT} = 3.5V	2.43	2.48	2.53	V

To be continued

Parameter	Symbol	Test Conditions	Min	Typ	Max	Unit
Full Charge Setting Range	I _{CHG_AC}		50	--	1000	mA
AC Charge Current Accuracy	I _{CHG_AC}	V _{BATT} = 3.8V, R _{ISSET} = 1.5kΩ	--	500	--	mA
Precharge						
BATT Pre-charge Threshold	V _{PRECH}		2.7	2.8	2.9	V
BATT Pre-charge Threshold Hysteresis	ΔV _{PRECH}		60	100	140	mV
Pre-Charge Current	I _{PCHG}	V _{BATT} = 2V	8	10	12	%
Recharge Threshold						
BATT Re-charge Falling Threshold Hysteresis	ΔV _{RECH_L}		50	95	140	mV
Charge Termination Detection						
Termination Current Ratio (Note 5)	I _{TERM}	V _{BATT} = 4.2V	--	10	--	%
Logic Input/Output						
CHG_S Pull Down Voltage	V _{CHG_S}	I _{CHG_S} = 5mA	--	213	--	mV
EN Threshold Voltage	Logic-High	V _{IH}	1.5	--	--	V
	Logic-Low	V _{IL}	--	--	0.4	V
EN Pin Input Current	I _{EN}		--	--	1.5	μA
ISETU Threshold	High Voltage	V _{ISETU_HIGH}	1.5	--	--	V
	Low Voltage	V _{ISETU_LOW}	--	--	0.4	V
ISETU Pin Input Current	I _{ISETU}		--	--	1.5	μA
USB Charge Current & Timing						
Soft-Start Time	T _{SS}	V _{ISETA} from 0V to 2.5V	--	100	--	μs
USB Charge Current	I _{CHG_USB}	V _{ACIN} = 3.5V, V _{USB} = 5V, V _{BATT} = 3.5V, I _{SETU} = 5V	400	450	500	mA
USB Charge Current	I _{CHG_USB}	V _{ACIN} = 3.5V, V _{USB} = 5V, V _{BATT} = 3.5V, I _{SETU} = 0V	60	80	100	mA
Timer						
TIME Pin Source Current	I _{TIME}	V _{TIMER} = 2V	--	1	--	μA
Pre-charge Fault Time	T _{PCHG_F}	C _{TIMER} = 0.1μF, f _{CLK} = 7Hz	1720	2460	3200	s
Charge Fault Time	T _{FCHG_F}	C _{TIMER} = 0.1μF, f _{CLK} = 7Hz	13790	19700	25610	s
Battery Temperature Sense						
TS Pin Source Current	I _{TS}	V _{TS} = 1.5V	96	102	108	μA
TS Pin Threshold	High Voltage	V _{TS_HIGH}	0.485	0.5	0.515	V
	Low Voltage	V _{TS_LOW}	2.45	2.5	2.55	V
Protection						
Thermal Regulation			--	125	--	°C
OVP SET Voltage		Internal Default	--	6.5	--	V
Power Path Controller						
BAT_ON Pull Low		As SYS Falling, V _{BATT} = 4V, SYS-BAT	-150	--	-20	mV

To be continued

Parameter	Symbol	Test Conditions	Min	Typ	Max	Unit
BAT_ÖN Pull High		As SYS Raising, V _{BATT} = 4V, SYS-BAT	-50	--	0	mV
BAT_ÖN Pull Low Switch Resistance		V _{BAT} = 4V	--	10	--	Ω
BAT_ÖN Pull High Switch Resistance		V _{ACIN} = 5V	--	30	--	Ω

Step-Down Converter

(V_{DD1,2} = 3.6V, V_{OUT1,2} = 2.5V, L = 2.2μH, C_{IN1,2} = 4.7μF, C_{OUT1,2} = 10μF, I_{MAX} = 1A, T_A = 25°C, unless otherwise specification)

Parameter	Symbol	Test Conditions	Min	Typ	Max	Unit	
Input Voltage Range	V _{DD1,2}		2.5	--	5.5	V	
Quiescent Current	I _{Qx}	I _{OUTx} = 0mA, V _{FB1,2} = V _{REF} + 5%	--	50	70	μA	
Shutdown Current	I _{SHDNx}	ENx = GND	--	0.1	1	μA	
Reference Voltage	V _{REF}		0.588	0.6	0.612	V	
Adjustable Output Range	V _{OUT1,2}	(Note 5)	V _{REF}	--	V _{DD1,2} - 0.2V	V	
Adjustable Output Voltage Accuracy	ΔV _{OUT}	V _{DD1,2} = V _{OUT1,2} + ΔV to 5.5V (Note 6) 0A < I _{OUT} < 1A	-3	--	3	%	
FB1, 2 Input Current	I _{FB1,2}	V _{FB1,2} = V _{DD1,2}	-50	--	50	nA	
P-MOSFET R _{ON}	R _{DS(ON)_P}	I _{OUT1,2} = 200mA	V _{DD1,2} = 3.6V	--	0.28	--	Ω
			V _{DD1,2} = 2.5V	--	0.38	--	
N-MOSFET R _{ON}	R _{DS(ON)_N}	I _{OUT1,2} = 200mA	V _{DD1,2} = 3.6V	--	0.25	--	Ω
			V _{DD1,2} = 2.5V	--	0.35	--	
P-Channel Current Limit	I _{LIM_P}	V _{DD1,2} = 2.5V to 5.5V	1.4	1.5	--	A	
EN1, 2 High-Level Input Voltage	V _{EN1,2_H}	V _{DD1,2} = 2.5V to 5.5V	1.5	--	--	V	
EN1, 2 Low-Level Input Voltage	V _{EN1,2_L}	V _{DD1,2} = 2.5V to 5.5V	--	--	0.4	V	
Under Voltage Lock Out threshold	UVLO		--	1.8	--	V	
Hysteresis			--	0.1	--	V	
Oscillator Frequency	f _{OSC}	V _{DD1,2} = 3.6V, I _{OUT1,2} = 100mA	1.2	1.5	1.8	MHz	
Thermal Shutdown Temperature	T _{SD}		--	160	--	°C	
Maximum Duty Cycle			100	--	--	%	
LX1, 2 Current Source		V _{DD1,2} = 3.6V, V _{LX1,2} = 0V or V _{LX1,2} = 3.6V	1	--	100	μA	

Note 1. Stresses listed as the above "Absolute Maximum Ratings" may cause permanent damage to the device. These are for stress ratings. Functional operation of the device at these or any other conditions beyond those indicated in the operational sections of the specifications is not implied. Exposure to absolute maximum rating conditions for extended periods may remain possibility to affect device reliability.

Note 2. θ_{JA} is measured in the natural convection at $T_A = 25^\circ\text{C}$ on a high effective four layers thermal conductivity test board of JEDEC 51-7 thermal measurement standard. The case point of θ_{JC} is on the expose pad for the WQFN package.

Note 3. Devices are ESD sensitive. Handling precaution is recommended.

Note 4. The device is not guaranteed to function outside its operating conditions.

Note 5. Guarantee by design.

Note 6. $\Delta V = I_{OUT} \times P_{RDS(ON)}$

Typical Operating Characteristics

Battery Charger

Charge Current vs. R_{SETA}

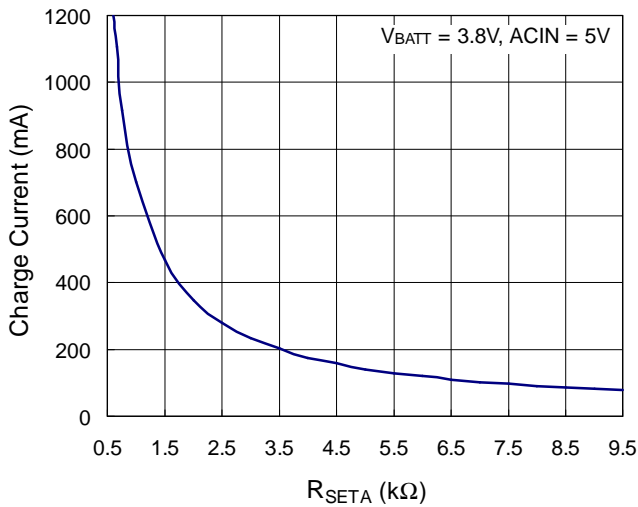

Enable Threshold Voltage vs. Input Voltage

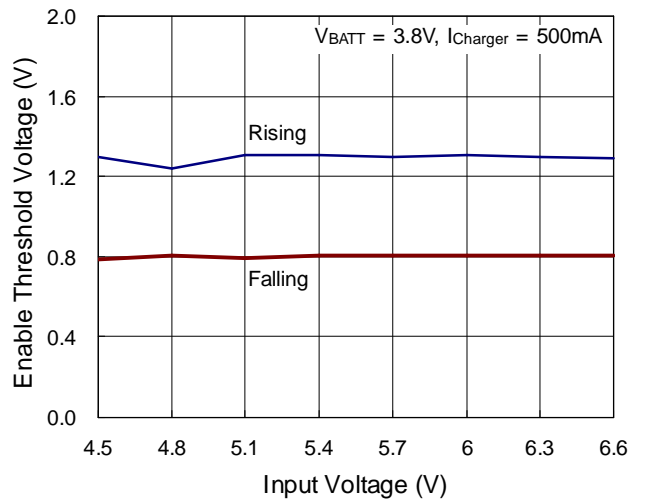

ISETA Voltage vs. ACIN Voltage

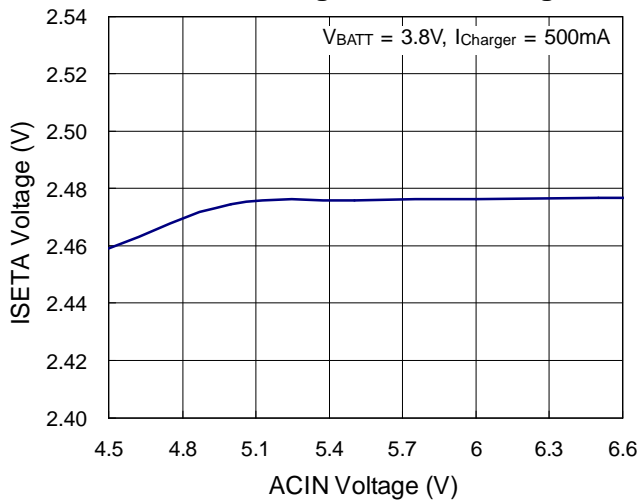

ISETA Voltage vs. Temperature

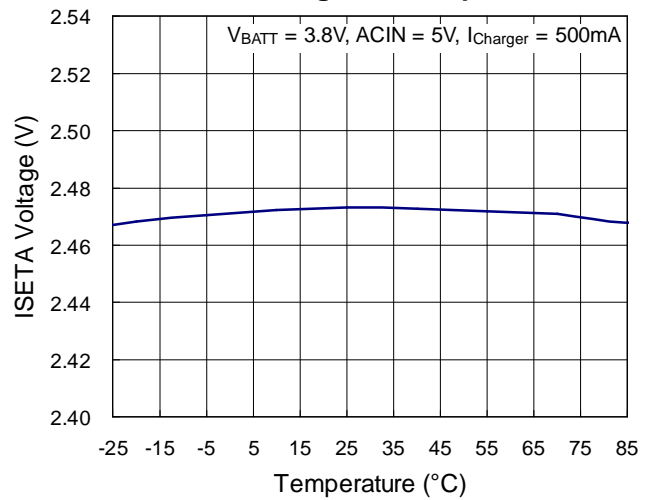

TS Current vs. Input Voltage

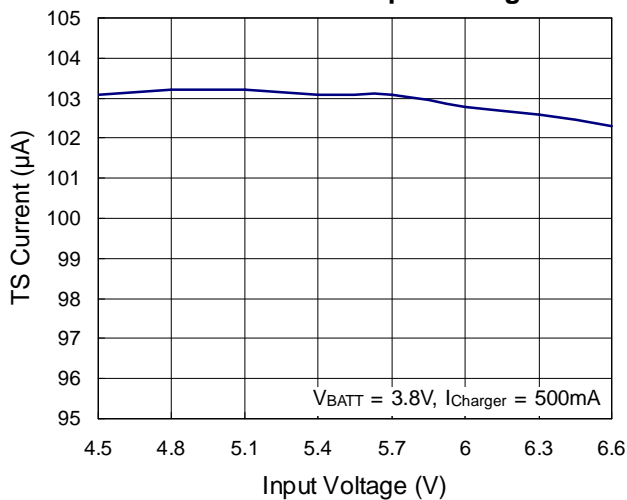

TS Current vs. Temperature

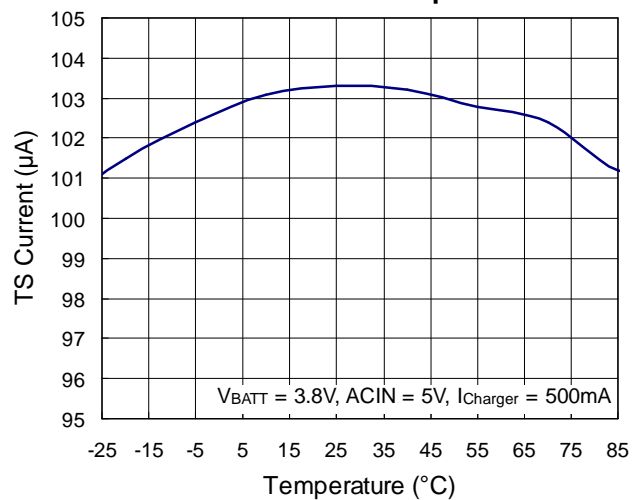

ISETU Threshold Voltage vs. USB Voltage

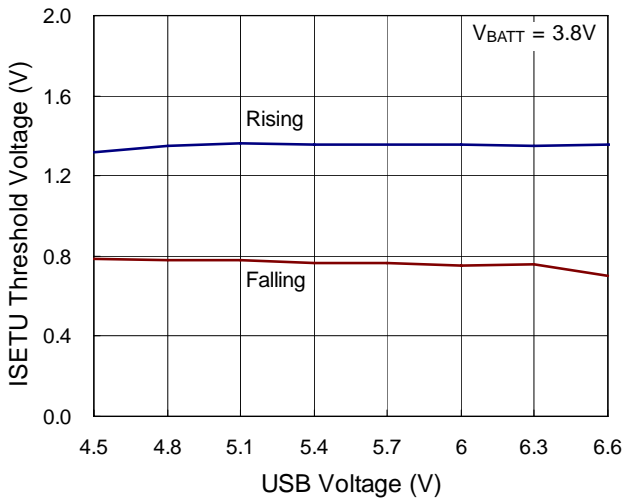

Regulation Voltage vs. Temperature

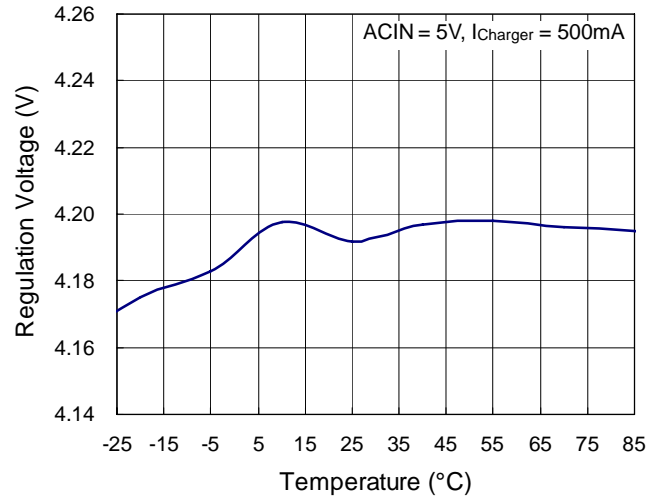

ACIN Power On

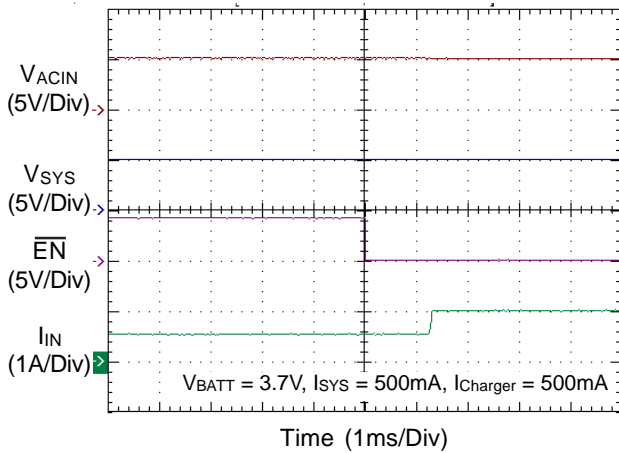

USB Power On

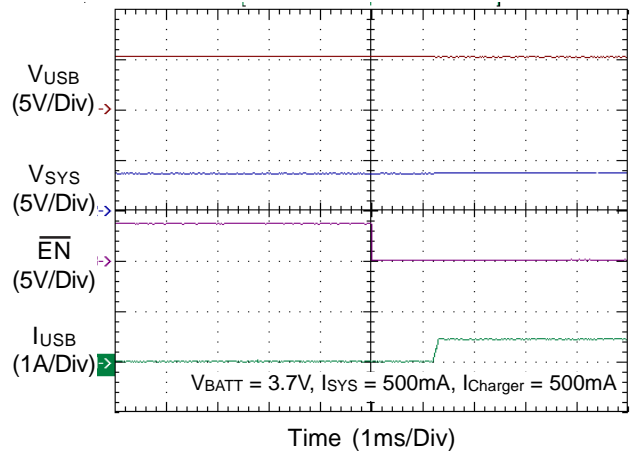

ACIN Power Off

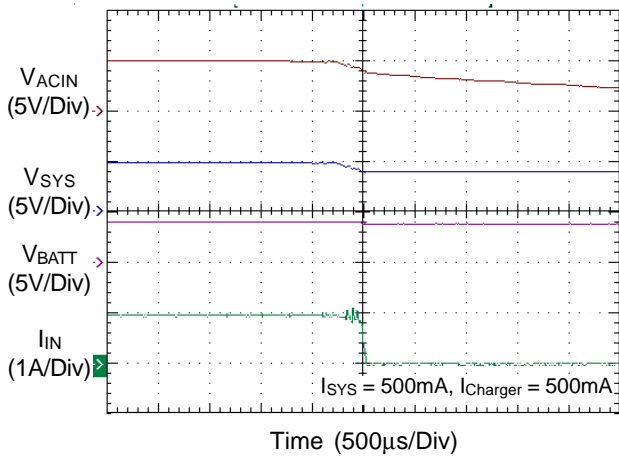

USB Power Off

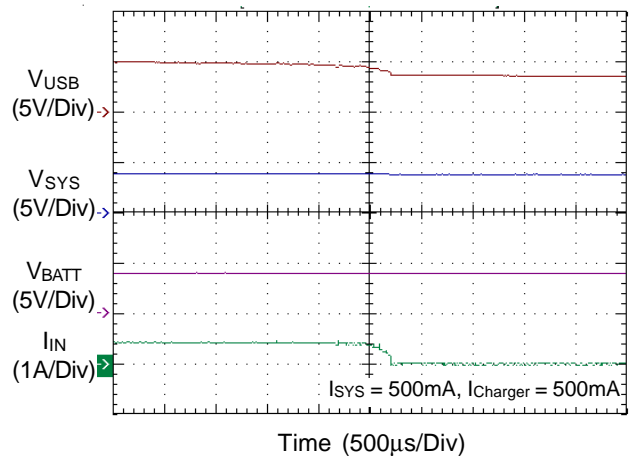

Step-Down Converter

Efficiency vs. Output Current

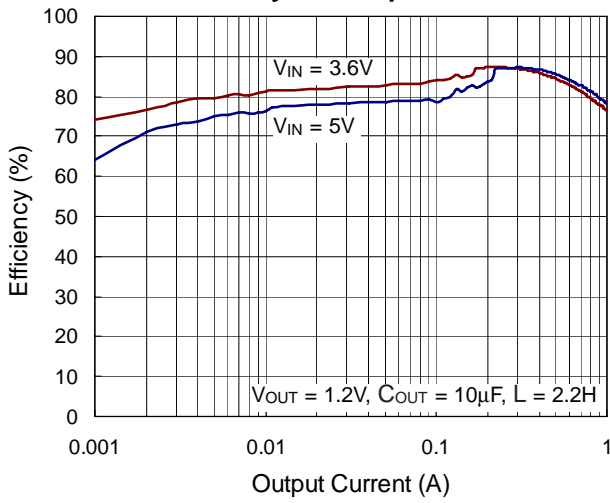

Output Voltage vs. Output Current

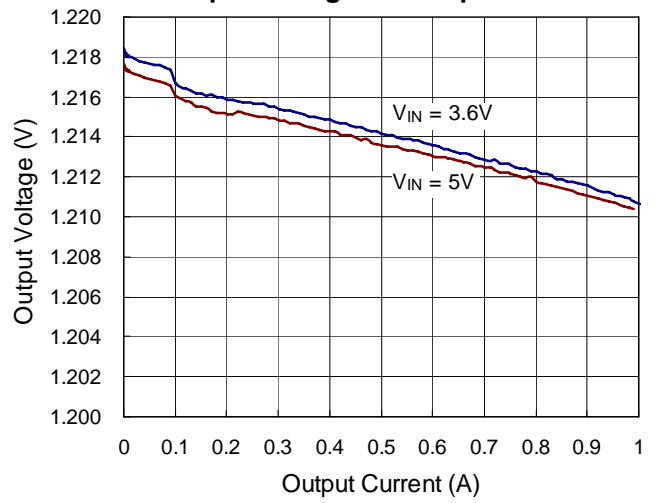

Output Voltage vs. Temperature

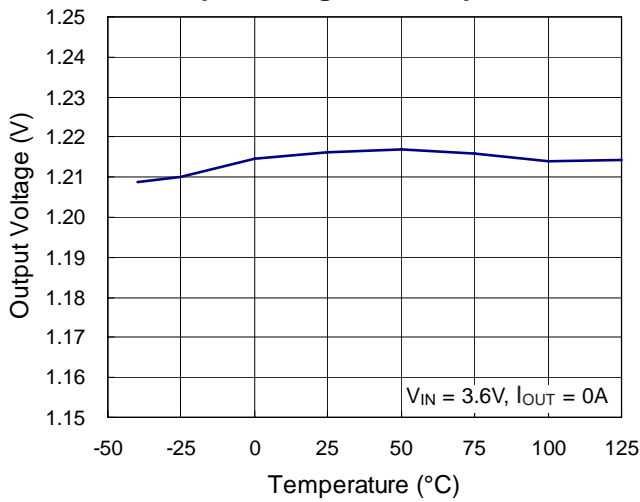

UVLO Threshold vs. Temperature

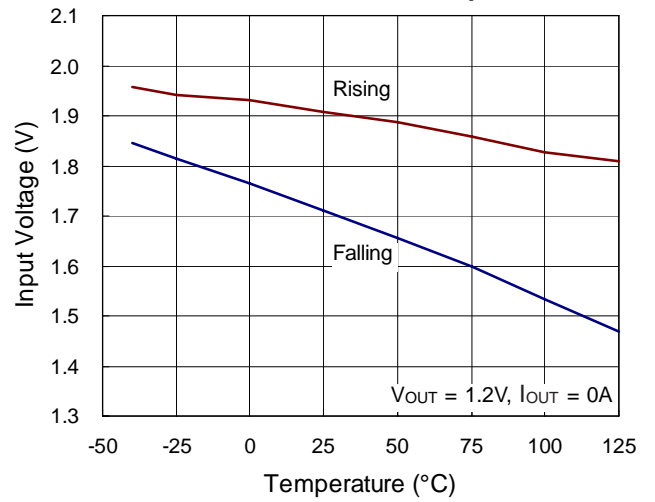

EN Threshold vs. Input Voltage

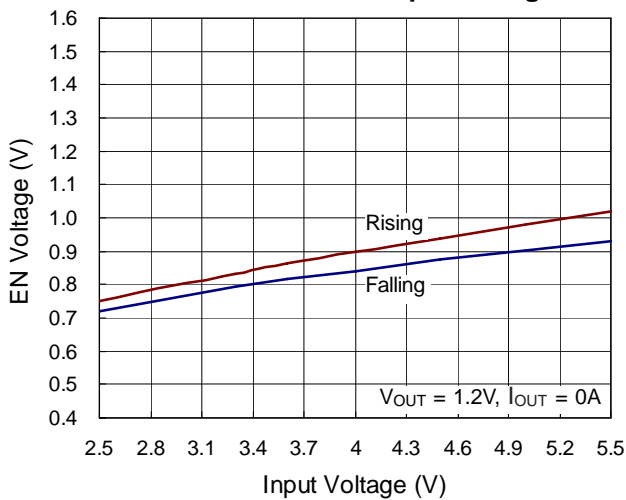

EN Threshold vs. Temperature

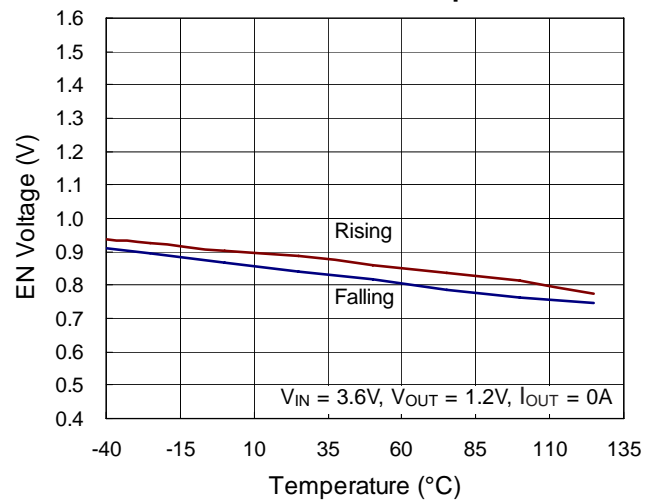

Frequency vs. Input Voltage

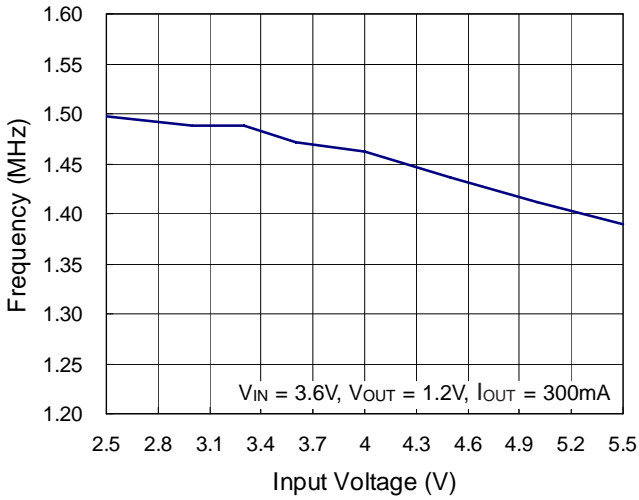

Frequency vs. Temperature

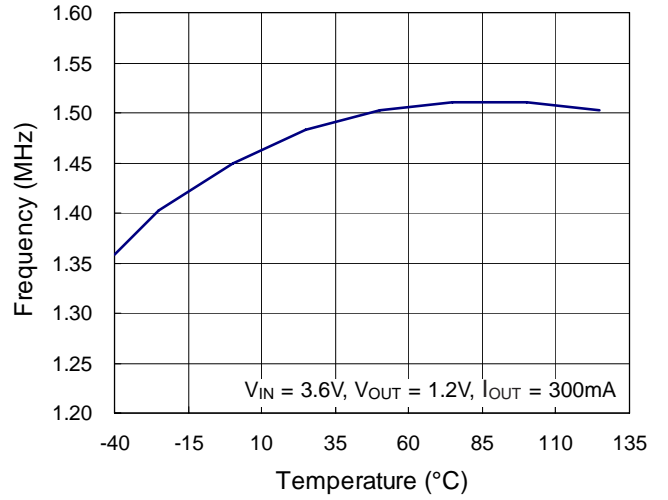

Current Limit vs. Input Voltage

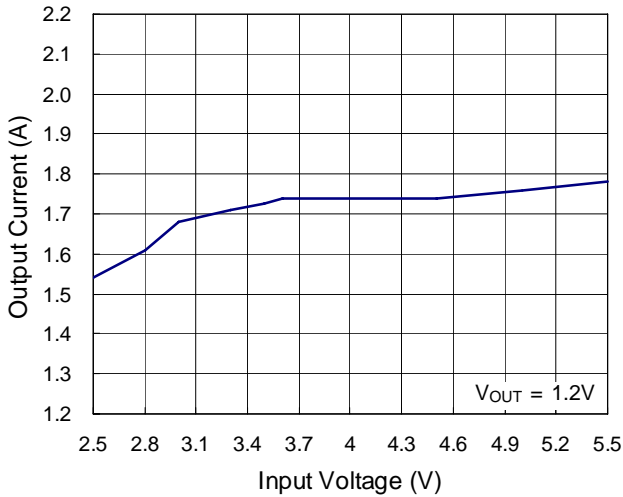

Current Limit vs. Temperature

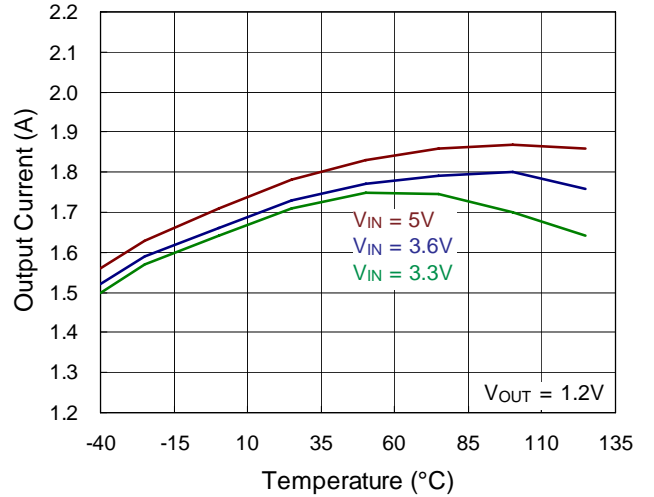

Output Ripple Voltage

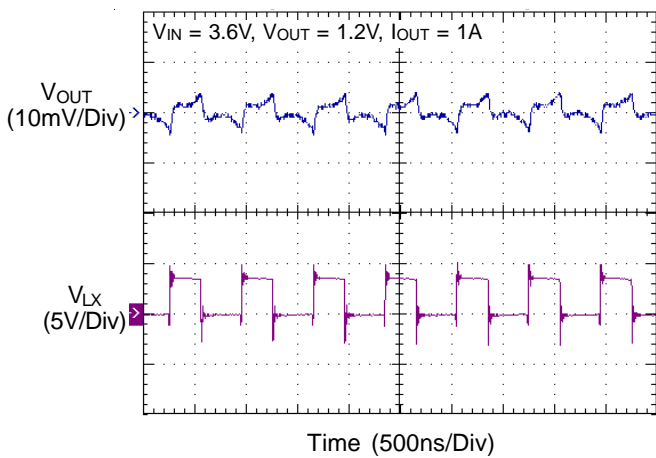

Output Ripple Voltage

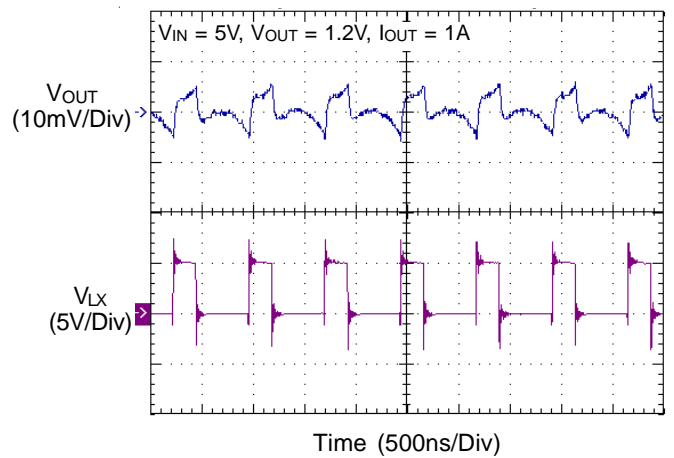

Power On from EN

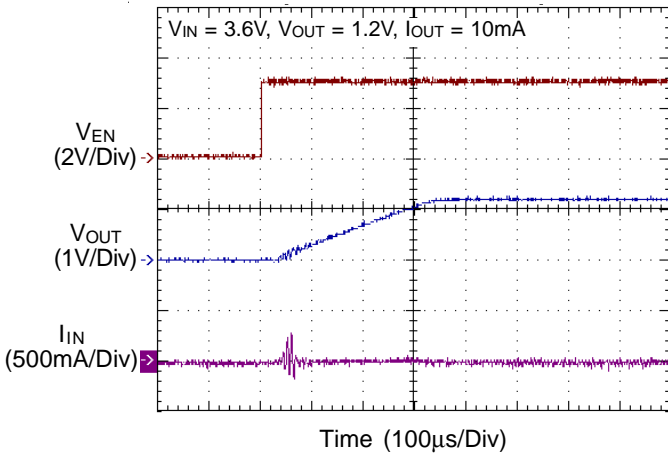

Power On from EN

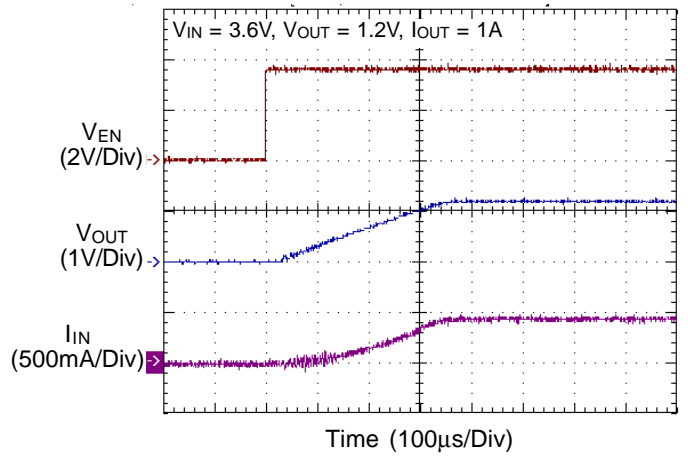

Power On from VIN

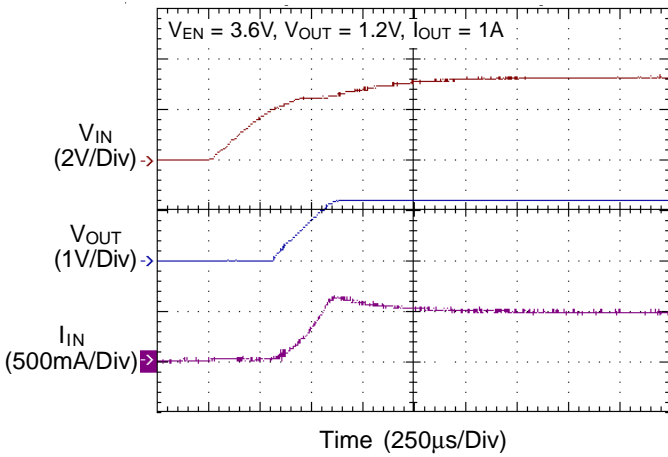

Power Off from EN

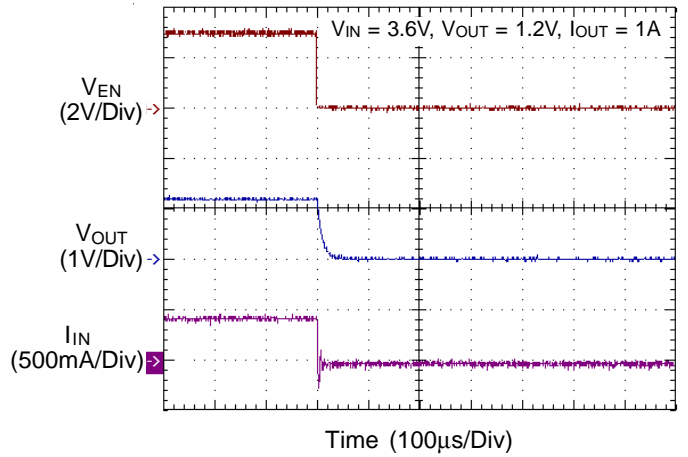

Load Transient Response

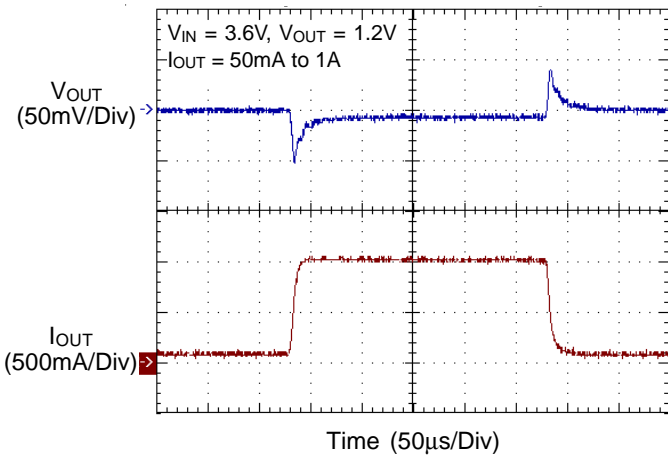

Load Transient Response

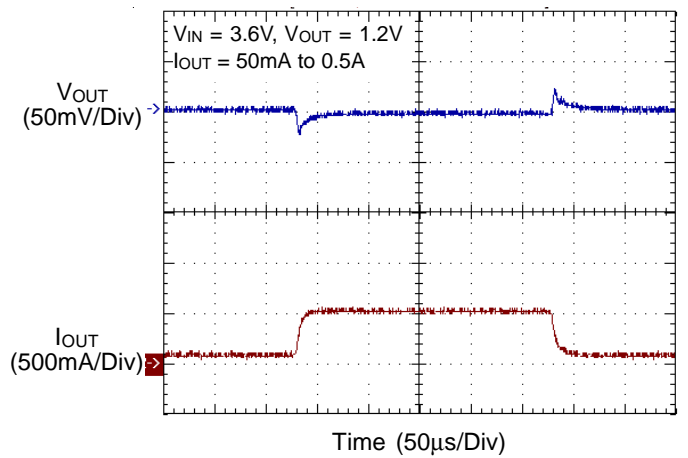

Load Transient Response

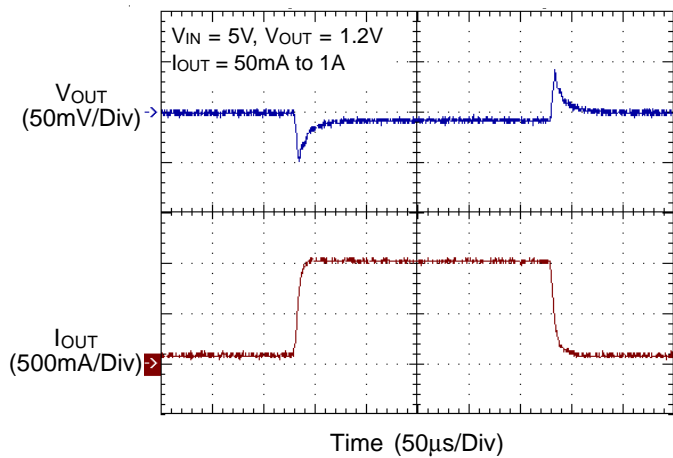

Load Transient Response

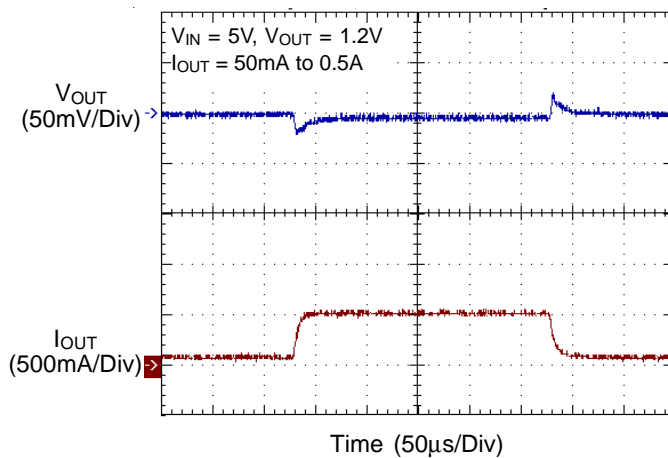

Application Information

The RT9511 is a fully integrated low cost single-cell Li-Ion battery charger and two high-efficiency step-down DC-DC converters ideal for portable applications.

Battery Charger

Automatically Power Source Selection

The RT9511 can be adopted for two input power source, ACIN and USB Inputs. It will automatically select the input source and operate in different mode as below.

ACIN Mode : When the adapter input voltage (V_{ACIN}) is higher than the UVP voltage level (4.3V), the RT9511 will enter ACIN Mode. In the ACIN Mode, ACIN P-MOSFET is turned on and USB P-MOSFET is turned off. When ACIN voltage is between the UVP and OVP threshold levels, the switch Q1 will be turned on and Q2 will be turned off. So, the system load is powered directly from the adapter through the transistor Q1, and the battery is charged by the RT9511. Once the ACIN voltage is higher than the OVP or is lower than the UVP threshold, the RT9511 stops charging, and then Q1 will be turned off and Q2 will be turned on to supply the system by battery.

USB Mode : When ACIN voltage is lower than UVP voltage level and USB input voltage is higher than UVP voltage level (3.9V), the RT9511 will operate in the USB Mode. In the USB Mode, ACIN P-MOSFET and Q1 are turned off and USB P-MOSFET and Q2 are turned on. The system load is powered directly from the USB/Battery through the switch Q2. Note that in this mode, the battery will be discharged once the system current is higher than the battery charge current.

Sleep Mode : The RT9511 will enter Sleep Mode when both ACIN and USB input voltage are removed. This feature provides low leakage current from the battery during the absence of input supply.

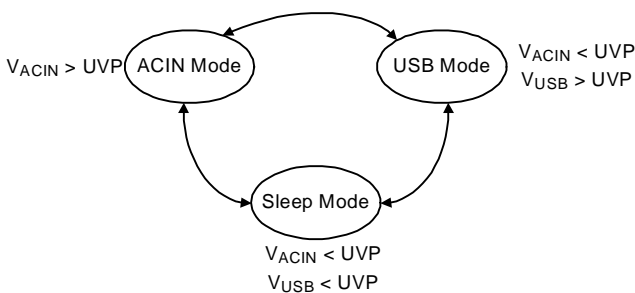

Figure 2. Input Power Source Operation Mode.

Power-Path Management

The RT9511 powers the system and independently charging the battery while the input is ACIN. This feature reduces the charge time, allows for proper charge termination, and allows the system to run with an absent or defective battery pack.

Case 1 : Input is ACIN

In this case, the system load is powered directly from the AC adapter through the transistor Q1. For the RT9511, Q1 and Q2 act as a switch as long as the RT9511 is ready. Once the ACIN voltage is ready ($>UVP$ and $<OVP$), the battery is charged by the RT9511 internal MOSFET and Q1 starts regulating the output voltage supply system (Q2 is turn off). Once the ACIN voltage is over operation voltage ($<UVP$ or $>OVP$), the RT9511 stops charging the battery, Q1 turns off and Q2 starts to supply power for system.

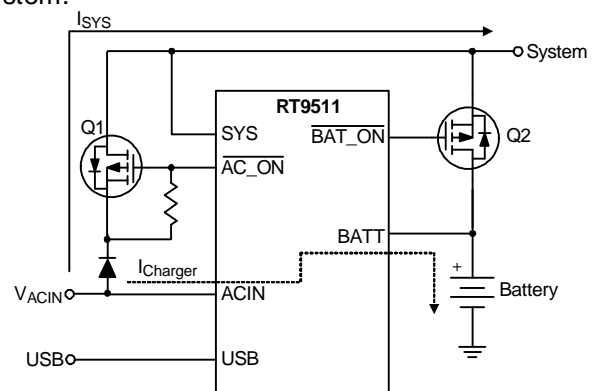

Figure 3. ACIN Input

Case 2 : Input is USB

In this case, the system load is powered directly from the battery through the switch Q2 (Q1 is turn off). Note that in this case, the system current over battery charge current will lead to battery discharge.

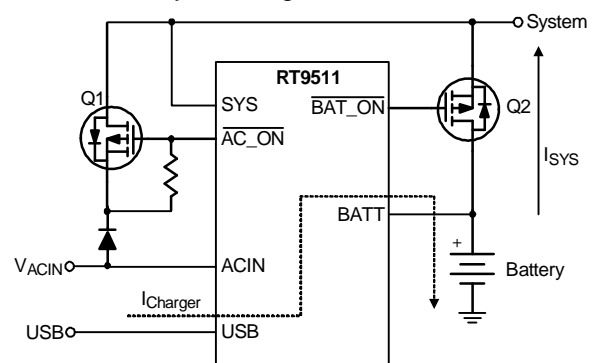

Figure 4. USB Input

C_{IN} Over Voltage Protection

The ACIN input voltage is monitored by an internal OVP comparator. The comparator has an accurate reference of 2.5V from the band-gap reference. The OVP threshold is set by the internal resistive. The protection threshold is set to 6.5V, but ACIN input voltage over 18V still leads the RT9511 to damage. When the input voltage exceeds the threshold, the comparator outputs a logic signal to turn off the power P-MOSFET to prevent the high input voltage from damaging the electronics in the handheld system. When the input over voltage condition is removed (ACIN < 6V), the comparator re-enables the output by running through the soft-start.

Battery Temperature Monitoring

The RT9511 continuously monitors battery temperature by measuring the voltage between the TS and GND pins. The RT9511 has an internal current source to provide the bias for the most common 10kΩ negative-temperature coefficient thermal resistor (NTC) (see Figure 5). The RT9511 compares the voltage on the TS pin against the internal VTS_HIGH and VTS_LOW thresholds to determine if charging is allowed. When the temperature outside the VTS_HIGH and VTS_LOW thresholds is detected, the device will immediately stop the charge. The RT9511 stops charging and keep monitoring the battery temperature when the temperature sense input voltage is back to the threshold between VTS_HIGH and VTS_LOW, the charger will be resumed. Charge is resumed when the temperature returns to the normal range. However, the user may modify thresholds by the negative-temperature coefficient thermal resistor or adding two external resistors. (see Figure 6.)

The capacitor should be placed close to TS (Pin 9) and connected to the ground plane. The capacitance value (0.1μF to 10μF) should be selected according to the quality of PCB layout. It is recommended to use a 10μF if the layout is poor to prevent noise.

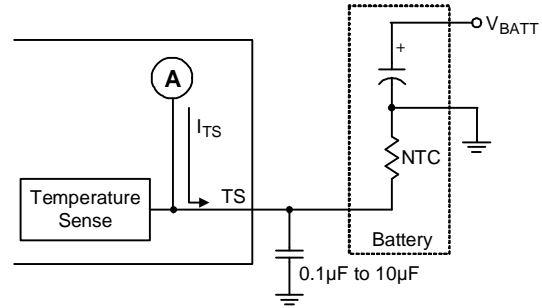

$$V_{TS} = I_{TS} \times R_{NTC}$$

Turn off when $V_{TS} \geq 2.5V$ or $V_{TS} \leq 0.5V$

Figure 5. Temperature Sensing Configuration

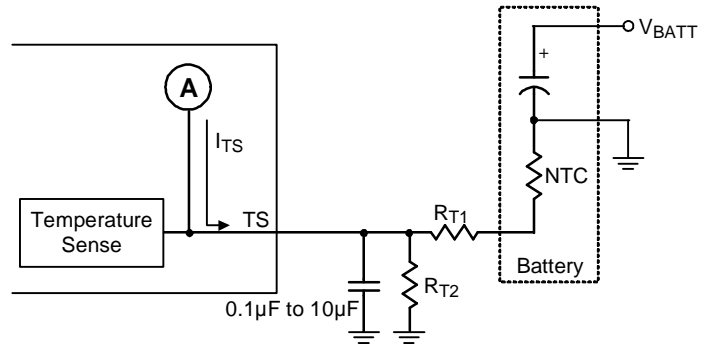

$$V_{TS} = I_{TS} \frac{R_{T2} \times (R_{T1} + R_{NTC})}{R_{T1} + R_{T2} + R_{NTC}}$$

Turn off when $V_{TS} \geq 2.5V$ or $V_{TS} \leq 0.5V$

Figure 6. Temperature Sensing Circuit

Fast-Charge Current Setting

Case 1: ACIN Mode

The RT9511 offers ISETA pin to determine the ACIN charge rate from 100mA to 1.2A. The charge current can be calculated as following equation.

$$I_{charge_ac} = K_{SET} \frac{V_{SET}}{R_{SETA}}$$

The parameter $K_{SET} = 300$; $V_{SET} = 2.5V$. R_{SETA} is the resistor connected between the ISETA and GND.

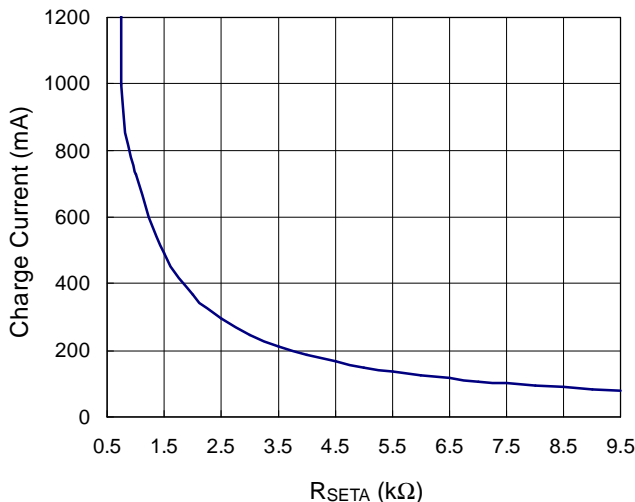

Figure 7. ACIN Mode Charge Current Setting

Case 2 : USB Mode

When charging from a USB port, the ISETU pin can be used to determine the charge current of 100mA or 500mA.

A low-level signal of the ISETU pin sets the charge current at 100mA and a high level signal sets the charge current at 500mA.

Pre- Charge Current Setting

During a charge cycle if the battery voltage is below the V_{PRECH} threshold, the RT9511 applies a pre-charge mode to the battery. This feature revives deeply discharged cells and protects battery life. The RT9511 internally determines the pre-charge rate as 10% of the fast-charge current.

Battery Voltage Regulation

The RT9511 monitors the battery voltage through the BATT pin. Once the battery voltage level closes to the V_{REG} threshold, the RT9511 voltage enters constant phase and the charging current begins to taper down. When battery voltage is over the V_{REG} threshold, the RT9511 will stop charge and keep to monitor the battery voltage. However, when the battery voltage decreases 100mV below the V_{REG} , it will be recharged to keep the battery voltage.

Charge Status Outputs

The open-drain $\overline{CHG_S}$ output indicates various charger operations as shown in the following table. These status pin can be used to drive LEDs or communicate to the host processor. Note that ON indicates the open-drain transistor is turned on and LED is bright.

Charge State		$\overline{CHG_S}$
ACIN	Charge	ON
	Charge Done	OFF
USB	Charge	ON
	Charge Done	OFF

Temperature Regulation and Thermal Protection

In order to maximize the charge rate, the RT9511 features a junction temperature regulation loop. If the power dissipation of the IC results in a junction temperature greater than the thermal regulation threshold (125°C), the RT9511 throttles back on the charge current in order to maintain a junction temperature around the thermal regulation threshold (125°C). The RT9511 monitors the junction temperature, T_J , of the die and disconnects the battery from the input if T_J exceeds 125°C. This operation continues until junction temperature falls below thermal regulation threshold (125°C) by the hysteresis level. This feature prevents the maximum power dissipation from exceeding typical design conditions.

External Timer

As a safety mechanism, the RT9511 has a user-programmable timer that monitors the pre-charge and fast charge time. This timer (charge safety timer) is started at the beginning of the pre-charge and fast charge period. The safety charge timeout value is set by the value of an external capacitor connected to the TMR pin (C_{TMR}), if pin TMR is short to GND, the charge safety timer is disabled.

As $C_{TMR} = 0.1\mu F$, T_{PRECH} is ~2460 secs and T_{FAULT} is $8 \times T_{PRECH}$. $T_{PRECH} = C_{TMR} \times 2460/0.1\mu$

As timer fault, re-plug-in power or pull high and re-pull low EN can release the fault condition.

As a safety mechanism, the RT9511 has a user-programmable timer that monitors the pre-charge and fast charge time. This timer (charge safe timer) is started at the beginning of the pre-charge and fast-charge period. The safety charge timeout value is set by an external capacitor (CT) connected between TIMER pin and GND. The timeout fault condition can be released by resetting the input power or the EN pin. If the TIMER is shorted to GND, the charge safety timer will be disabled.

Selecting the Input and Output Capacitors

In most applications, the most important is the high frequency decoupling capacitor on the input of the RT9511.

A 1µF ceramic capacitor, placed in close proximity to input pin and GND pin is recommended. In some applications depending on the power supply characteristics and cable length, it may be necessary to add an additional 10µF ceramic capacitor to the input. The RT9511 requires a small output capacitor for loop stability. A 1µF ceramic capacitor placed between the BATT pin and GND is typically sufficient.

Step-Down DC-DC Converters

Inductor Selection

For a given input and output voltage, the inductor value and operating frequency determine the ripple current. The ripple current ΔI_L increases with higher V_{IN} and decreases with higher inductance.

$$\Delta I_L = \left[\frac{V_{OUT}}{f \times L} \right] \times \left[1 - \frac{V_{OUT}}{V_{IN}} \right]$$

Having a lower ripple current reduces the ESR losses in the output capacitors and the output voltage ripple. Highest efficiency operation is achieved at low frequency with small ripple current. This, however, requires a large inductor.

A reasonable starting point for selecting the ripple current is $\Delta I_L = 0.4(I_{MAX})$. The largest ripple current occurs at the highest V_{IN} . To guarantee that the ripple current stays below a specified maximum, the inductor value should be chosen according to the following equation :

$$L = \left[\frac{V_{OUT}}{f \times \Delta I_L(MAX)} \right] \times \left[1 - \frac{V_{OUT}}{V_{IN(MAX)}} \right]$$

Inductor Core Selection

Once the value for L is known, the type of inductor must be selected. High efficiency converters generally cannot afford the core loss found in low cost powdered iron cores, forcing the use of more expensive ferrite or mollypermalloy cores. Actual core loss is independent of core size for a fixed inductor value but it is very dependent on the inductance selected. As the inductance increases, core losses decrease. Unfortunately, increased inductance requires more turns of wire and therefore copper losses will increase.

Ferrite designs have very low core losses and are preferred at high switching frequencies, so design goals can concentrate on copper loss and preventing saturation. Ferrite core material saturates "hard", which means that inductance collapses abruptly when the peak design current is exceeded. This results in an abrupt increase in inductor ripple current and consequent output voltage ripple.

Do not allow the core to saturate! Different core materials and shapes will change the size/ current and price/current relationship of an inductor.

Toroid or shielded pot cores in ferrite or permalloy materials are small and don't radiate energy but generally cost more than powdered iron core inductors with similar characteristics. The choice of which style inductor to use mainly depends on the price vs. size requirements and any radiated field/EMI requirements.

C_{IN} and C_{OUT} Selection

The input capacitance, C_{IN} , is needed to filter the trapezoidal current at the source of the top MOSFET. To prevent large ripple voltage, a low ESR input capacitor sized for the maximum RMS current should be used. RMS current is given by :

$$I_{RMS} = I_{OUT(MAX)} \frac{V_{OUT}}{V_{IN}} \sqrt{\frac{V_{IN}}{V_{OUT}} - 1}$$

This formula has a maximum at $V_{IN} = 2V_{OUT}$, where $I_{RMS} = I_{OUT}/2$. This simple worst-case condition is commonly used for design because even significant deviations do not offer much relief. Choose a capacitor rated at a higher temperature than required. Several capacitors may also be paralleled to meet size or height requirements in the design.

The selection of C_{OUT} is determined by the effective series resistance (ESR) that is required to minimize voltage ripple and load step transients, as well as the amount of bulk capacitance that is necessary to ensure that the control loop is stable. Loop stability can be checked by viewing the load transient response as described in a later section.

The output ripple, ΔV_{OUT} , is determined by :

$$\Delta V_{OUT} \leq \Delta I_L \left[ESR + \frac{1}{8fC_{OUT}} \right]$$

The output ripple is highest at maximum input voltage since ΔI_L increases with input voltage. Multiple capacitors placed in parallel may be needed to meet the ESR and RMS current handling requirements. Dry tantalum, special polymer, aluminum electrolytic and ceramic capacitors are all available in surface mount packages. Special polymer capacitors offer very low ESR but have lower capacitance density than other types. Tantalum capacitors have the highest capacitance density but it is important to only use types that have been surge tested for use in switching power supplies. Aluminum electrolytic capacitors have significantly higher ESR but can be used in cost-sensitive applications provided that consideration is given to ripple current ratings and long term reliability. Ceramic capacitors have excellent low ESR characteristics but can have a high voltage coefficient and audible piezoelectric effects. The high Q of ceramic capacitors with trace inductance can also lead to significant ringing.

Using Ceramic Input and Output Capacitors

Higher values, lower cost ceramic capacitors are now becoming available in smaller case sizes. Their high ripple current, high voltage rating and low ESR make them ideal for switching regulator applications. However, care must be taken when these capacitors are used at the input and output. When a ceramic capacitor is used at the input and the power is supplied by a wall adapter through long wires, a load step at the output can induce ringing at the input, V_{IN} . At best, this ringing can couple to the output and be mistaken as loop instability. At worst, a sudden inrush of current through the long wires can potentially cause a voltage spike at V_{IN} large enough to damage the part.

Output Voltage Programming

The resistive divider allows the FB pin to sense a fraction of the output voltage as shown in Figure 8.

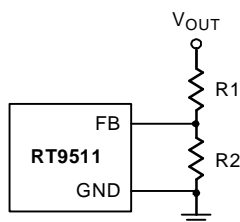

Figure 8. Setting the Output Voltage

For adjustable voltage mode, the output voltage is set by an external resistive divider according to the following equation :

$$V_{OUT} = V_{REF} \left(1 + \frac{R1}{R2}\right)$$

where V_{REF} is the internal reference voltage (0.6V typ.)

Efficiency Considerations

The efficiency of a switching regulator is equal to the output power divided by the input power times 100%. It is often useful to analyze individual losses to determine what is limiting the efficiency and which change would produce the most improvement. Efficiency can be expressed as :

$$\text{Efficiency} = 100\% - (L1 + L2 + L3 + \dots)$$

where $L1$, $L2$, etc. are the individual losses as a percentage of input power. Although all dissipative elements in the circuit produce losses, two main sources usually account for most of the losses: V_{IN} quiescent current and I^2R losses.

The V_{IN} quiescent current loss dominates the efficiency loss at very low load currents whereas the I^2R loss dominates the efficiency loss at medium to high load currents. In a typical efficiency plot, the efficiency curve at very low load currents can be misleading since the actual power lost is of no consequence.

1. The V_{IN} quiescent current appears due to two factors including : the DC bias current as given in the electrical characteristics and the internal main switch and synchronous switch gate charge currents. The gate charge current results from switching the gate capacitance of the internal power MOSFET switches. Each time the gate is switched from high to low to high again, a packet of charge ΔQ moves from V_{IN} to ground.

The resulting $\Delta Q/\Delta t$ is the current out of V_{IN} that is typically larger than the DC bias current. In continuous mode, $I_{GATECHG} = f(Q_T + Q_B)$

where Q_T and Q_B are the gate charges of the internal top and bottom switches. Both the DC bias and gate charge losses are proportional to V_{IN} and thus their effects will be more pronounced at higher supply voltages. 2. I^2R losses are calculated from the resistances of the internal switches, R_{SW} and external inductor R_L . In continuous

mode, the average output current flowing through inductor L is “chopped” between the main switch and the synchronous switch. Thus, the series resistance looking into the LX pin is a function of both top and bottom MOSFET $R_{DS(ON)}$ and the duty cycle (DC) as follows :

$$R_{SW} = R_{DS(ON)TOP} \times DC + R_{DS(ON)BOT} \times (1-DC)$$

The $R_{DS(ON)}$ for both the top and bottom MOSFETs can be obtained from the Typical Performance Characteristics curves. Thus, to obtain I^2R losses, simply add R_{SW} to R_L and multiply the result by the square of the average output current.

Other losses including C_{IN} and C_{OUT} ESR dissipative losses and inductor core losses generally account for less than 2% of the total loss.

Checking Transient Response

The regulator loop response can be checked by looking at the load transient response. Switching regulators take several cycles to respond to a step in load current. When a load step occurs, V_{OUT} immediately shifts by an amount equal to ΔI_{LOAD} (ESR), where ESR is the effective series resistance of C_{OUT} . ΔI_{LOAD} also begins to charge or discharge C_{OUT} generating a feedback error signal used by the regulator to return V_{OUT} to its steady-state value.

During this recovery time, V_{OUT} can be monitored for overshoot or ringing that would indicate a stability problem.

Thermal Considerations

For continuous operation, do not exceed absolute maximum operation junction temperature. The maximum power dissipation depends on the thermal resistance of IC package, PCB layout, the rate of surroundings airflow and temperature difference between junction to ambient. The maximum power dissipation can be calculated by following formula :

$$P_{D(MAX)} = (T_{J(MAX)} - T_A) / \theta_{JA}$$

Where $T_{J(MAX)}$ is the maximum operation junction temperature 125°C, T_A is the ambient temperature and the θ_{JA} is the junction to ambient thermal resistance.

For recommended operating conditions specification of the RT9511, the maximum junction temperature is 125°C. The junction to ambient thermal resistance θ_{JA} is layout dependent. For WQFN-24L 4x4 packages, the thermal

resistance θ_{JA} is 52°C/W on the standard JEDEC 51-7 four layers thermal test board. The maximum power dissipation at $T_A = 25^\circ\text{C}$ can be calculated by following formula :

$$P_{D(MAX)} = (125^\circ\text{C} - 25^\circ\text{C}) / (52^\circ\text{C/W}) = 1.923\text{W for WQFN-24L 4x4 packages}$$

The maximum power dissipation depends on operating ambient temperature for fixed $T_{J(MAX)}$ and thermal resistance θ_{JA} . For RT9511 packages, the Figure 9 of derating curves allows designers to see the effect of rising ambient temperature on the maximum power dissipation allowed.

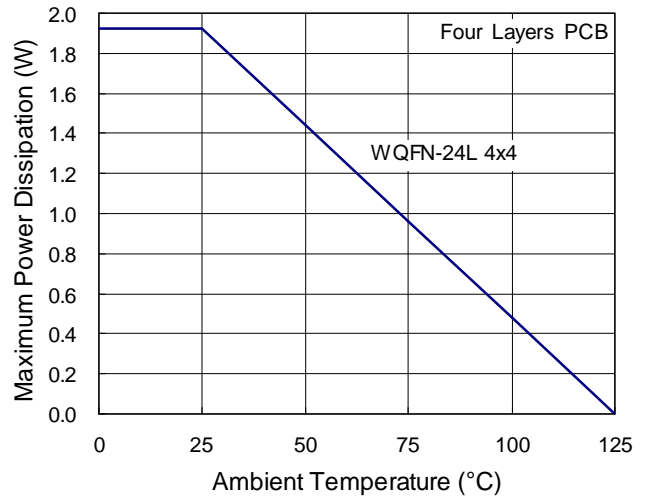

Figure 9. Derating Curves for RT9511 Packages

Layout Consideration

The RT9511 is a fully integrated solution for portable applications including a single-cell Li- Ion battery charger and two ideal high-efficiency step-down DC-DC converters ideal. Careful PCB layout is necessary. For best performance of the RT9511, the following guidelines should be strictly followed.

- } Input capacitors should be placed close to the IC and connected to ground plane.
- } The GND and Exposed Pad should be connected to a strong ground plane for heat sinking and noise protection.
- } The connection of R_{SETA} should be isolated from other noisy traces. The short wire is recommended to prevent noise coupling.

- } Output capacitors should be placed close to the IC and connected to ground plane to reduce noise coupling.
- } Keep the main current traces as possible as short and wide.
- } LX node of step-down DC-DC converter is with high frequency voltage swing. It should be kept at a small area.
- } Place the feedback components as close as possible to the IC and keep away from the noisy devices.

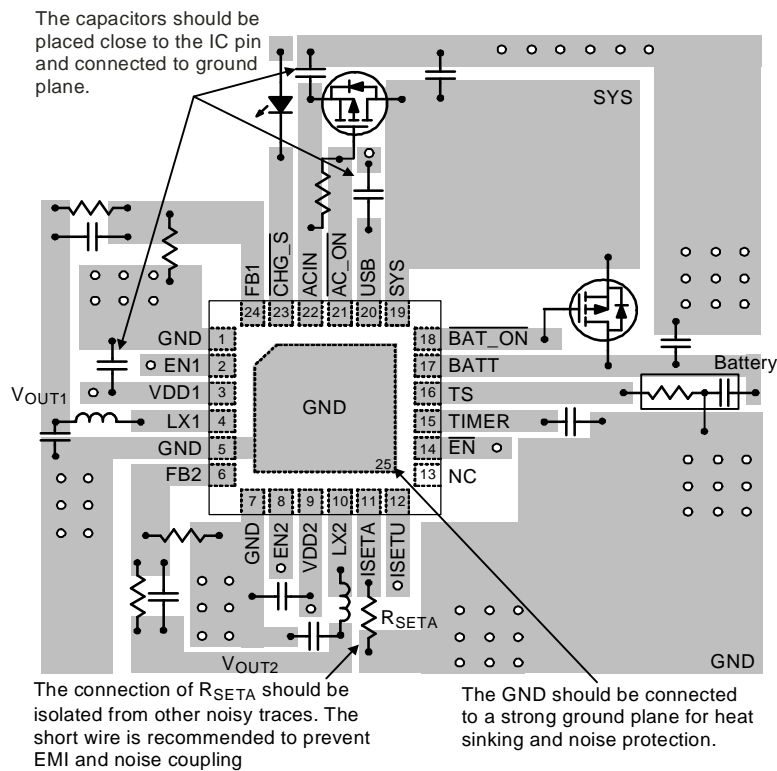

Figure 10. PCB Layout Guide

Table 1. Recommended Inductors

Supplier	Inductance (mH)	Current Rating (mA)	DCR (mW)	Dimensions (mm)	Series
TAIYO YUDEN	2.2	1480	60	3.00 x 3.00 x 1.50	NR 3015
GOTREND	2.2	1500	58	3.85 x 3.85 x 1.80	GTSD32
Sumida	2.2	1500	75	4.50 x 3.20 x 1.55	CDRH2D14
Sumida	4.7	1000	135	4.50 x 3.20 x 1.55	CDRH2D14
TAIYO YUDEN	4.7	1020	120	3.00 x 3.00 x 1.50	NR 3015
GOTREND	4.7	1100	146	3.85 x 3.85 x 1.80	GTSD32

Table 2. Recommended Capacitors for C_{IN} and C_{OUT}

Supplier	Capacitance (mF)	Package	Part Number
TDK	4.7	603	C1608JB0J475M
MURATA	4.7	603	GRM188R60J475KE19
TAIYO YUDEN	4.7	603	JMK107BJ475RA
TAIYO YUDEN	10	603	JMK107BJ106MA
TDK	10	805	C2012JB0J106M
MURATA	10	805	GRM219R60J106ME19
MURATA	10	805	GRM219R60J106KE19
TAIYO YUDEN	10	805	JMK212BJ106RD

Outline Dimension

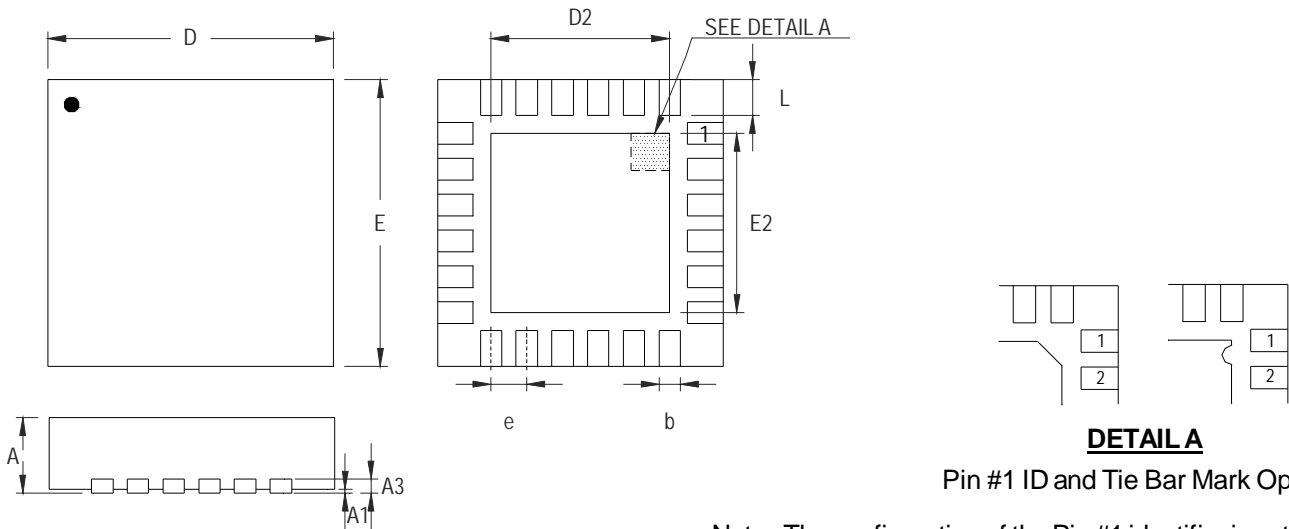

DETAIL A
Pin #1 ID and Tie Bar Mark Options

Note : The configuration of the Pin #1 identifier is optional, but must be located within the zone indicated.

Symbol	Dimensions In Millimeters		Dimensions In Inches	
	Min	Max	Min	Max
A	0.700	0.800	0.028	0.031
A1	0.000	0.050	0.000	0.002
A3	0.175	0.250	0.007	0.010
b	0.180	0.300	0.007	0.012
D	3.950	4.050	0.156	0.159
D2	2.300	2.750	0.091	0.108
E	3.950	4.050	0.156	0.159
E2	2.300	2.750	0.091	0.108
e	0.500		0.020	
L	0.350	0.450	0.014	0.018

W-Type 24L QFN 4x4 Package

Richtek Technology Corporation

Headquarter
5F, No. 20, Taiyuen Street, Chupei City
Hsinchu, Taiwan, R.O.C.
Tel: (8863)5526789 Fax: (8863)5526611

Richtek Technology Corporation

Taipei Office (Marketing)
5F, No. 95, Minchiuan Road, Hsintien City
Taipei County, Taiwan, R.O.C.
Tel: (8862)86672399 Fax: (8862)86672377
Email: marketing@richtek.com

Information that is provided by Richtek Technology Corporation is believed to be accurate and reliable. Richtek reserves the right to make any change in circuit design, specification or other related things if necessary without notice at any time. No third party intellectual property infringement of the applications should be guaranteed by users when integrating Richtek products into any application. No legal responsibility for any said applications is assumed by Richtek.