

FRED

Ultrafast Soft Recovery Diode, 60A × 2



FEATURES

- Fast recovery time characteristic
- Electrically isolated base plate
- Large creepage distance between terminal
- Simplified mechanical designs, rapid assembly
- Compliant to RoHS
- Designed and for industrial level



DESCRIPTION

This SOT-227 modules with FRED rectifier are available in two basic configurations. They are the antiparallel and the parallel configurations. The antiparallel configuration NST120F60-A is used for simple series rectifier and high voltage application. The parallel configuration NST120F60 is used for simple parallel rectifier and high current application. The semiconductor in the SOT-227 package is isolated from the copper base plate, allowing for common heatsinks and compact assemblies to be built. These modules are intended for general applications such as power supplies, battery chargers, electronic welders, motor control, DC chopper, and inverters.

CIRCUIT CONFIGURATION

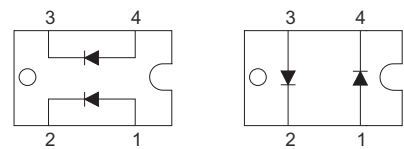

Parallel
NST120F120

Anti-Parallel
NST120F120-A

APPLICATIONS

- Switching power supplies
- Inverters
- Motor controllers
- Converters
- Snubber diodes
- Uninterruptible power supplies (UPS)
- Induction heating
- High speed rectifiers

PRODUCT SUMMARY

V_R	600 V
V_F (typical) at 125 °C	1.4 V
Q_{rr} (typical)	220nC
I_{RRM} (typical)	4A
t_{rr} (typical)	40 ns
$I_{F(DC)}$ at T_C per diode	60A at 100 °C

ABSOLUTE MAXIMUM RATINGS

PARAMETER	SYMBOL	TEST CONDITIONS	VALUES	UNITS
Cathode to anode voltage	V_R		600	V
Maximum continuous forward current $\frac{\text{per leg}}{\text{per module}}$	I_F	$T_c = 100\text{ °C}$	60 120	A
Single pulse forward current	I_{FSM}	$T_J = 25\text{ °C}$	800	
RMS isolation voltage, any terminal to case	V_{ISOL}	$t = 1\text{ minute}$	2500	V
Maximum power dissipation	P_D	$T_c = 25\text{ °C}$ $T_c = 100\text{ °C}$	180 71	W
Operating junction and storage temperature range	T_J, T_{Stg}		- 55 to 150	°C

Nell High Power Products

ELECTRICAL SPECIFICATIONS (T _J = 25 °C unless otherwise specified)						
PARAMETER	SYMBOL	TEST CONDITIONS	MIN.	TYP.	MAX.	UNITS
Cathode to anode breakdown voltage	V _{BR}	I _R = 100 μA	600	-	-	V
Maximum forward voltage	V _{FM}	I _F = 60 A	-	1.6	1.8	
		I _F = 120 A	-	1.9	2.1	
		I _F = 60 A, T _J = 125 °C	-	1.4	1.6	
Maximum reverse leakage current	I _{RM}	V _R = V _R rated	-	2	20	μA
		T _J = 125 °C, V _R = V _R rated	-	-	2000	
Junction capacitance	C _T	V _R = 200V	90			pF

DYNAMIC RECOVERY CHARACTERISTICS PERLEG (T _J = 25 °C unless otherwise specified)						
PARAMETER	SYMBOL	TEST CONDITIONS	MIN.	TYP.	MAX.	UNITS
Reverse recovery time	t _{rr}	I _F = 0.5A, I _R = 1.0A, I _{RR} = 250mA (RG#1 CKT)	-	50	60	ns
		I _F = 1.0 A, di _F /dt = -100 A/μs, V _R = 30 V, T _J = 25 °C	-	40	-	
	t _{rr1}	T _J = 25 °C	-	130	-	
	t _{rr2}	T _J = 125 °C	-	170	-	
Reverse recovery time	I _{RRM1}	T _J = 25 °C	-	4	-	A
	I _{RRM2}	T _J = 125 °C	-	10	-	
Reverse recovery time	Q _{rr1}	T _J = 25 °C	-	220	-	nC
	Q _{rr2}	T _J = 125 °C	-	920	-	

THERMAL - MECHANICAL SPECIFICATIONS (T _J = 25 °C unless otherwise specified)						
PARAMETER	SYMBOL	MIN.	TYP.	MAX.	UNITS	
Junction to case, single leg conducting	R _{thJC}	-	-	0.7	°C/W K/W	
Junction to case, both legs conducting		-	-	0.35		
Case to sink, flat, greased surface	R _{thCS}	-	0.05	-		
Weight		-	30	-	g	
Mounting torque		-	-	1.1	Nm	

Fig.1a Maximum effective transient thermal impedance, junction-to-case vs. pulse duration

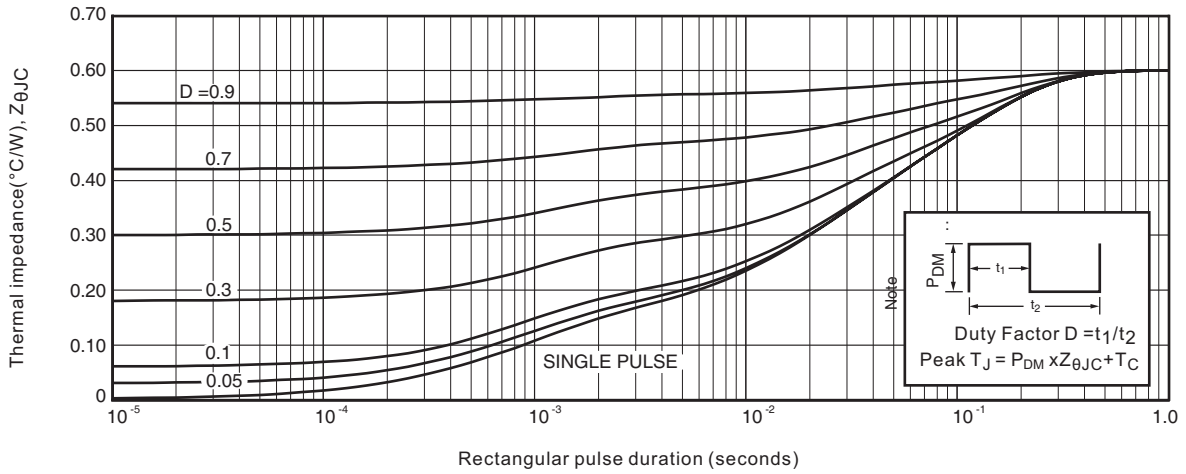

Fig.1b transient thermal impedance model

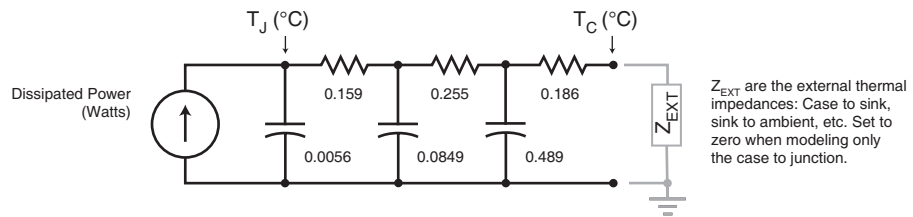

Fig.2 Forward current vs. forward voltage

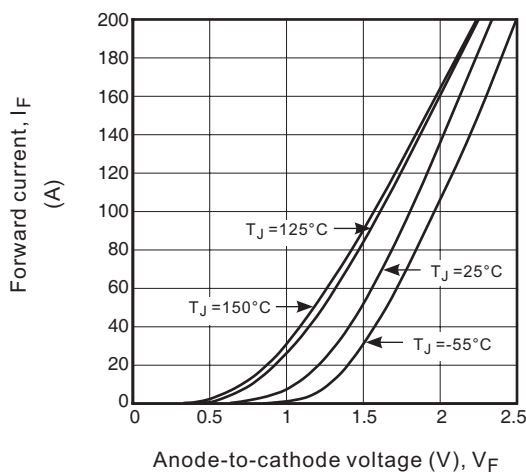
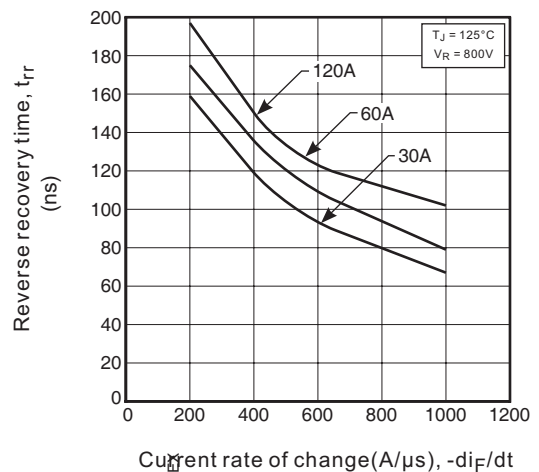

Fig.3 Reverse recovery time vs. current rate of change



Nell High Power Products

Fig.4 Reverse recovery charge vs. current rate of change

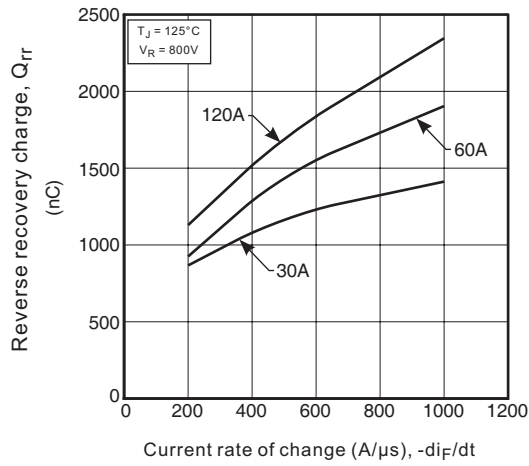

Fig 5. Reverse recovery current vs. current rate of change

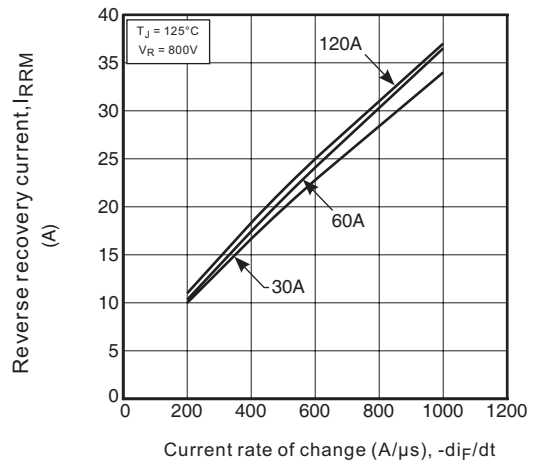

Fig6. Dynamic parameters vs. junction temperature

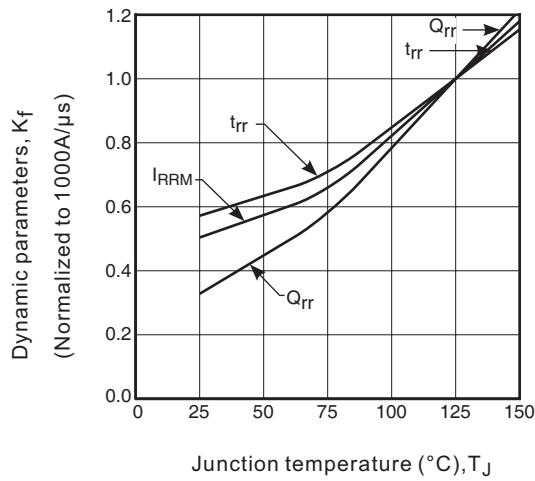

Fig.7 Maximum average forward current vs. case temperature

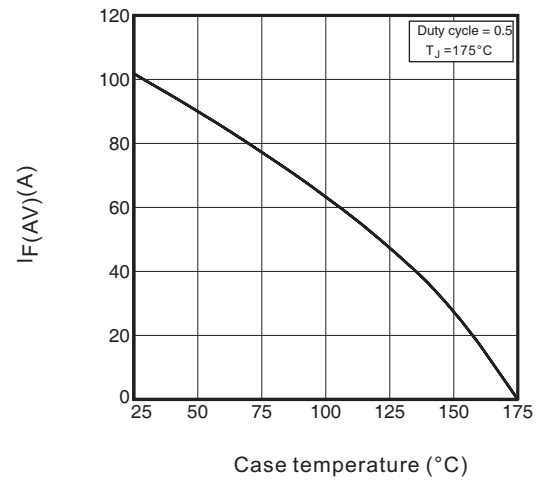

Fig.8 Junction capacitance vs. reverse voltage

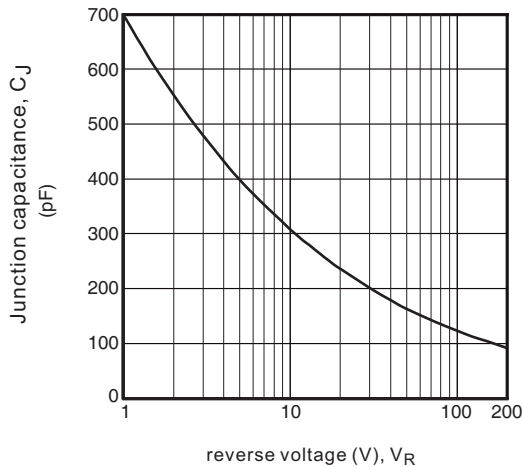

Fig.9 Reverse recovery parameter test circuit

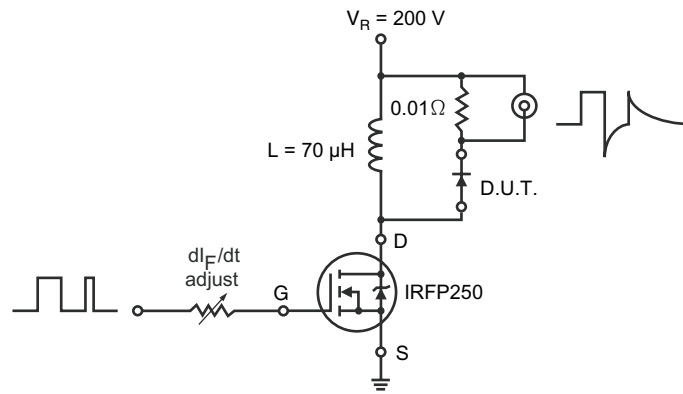
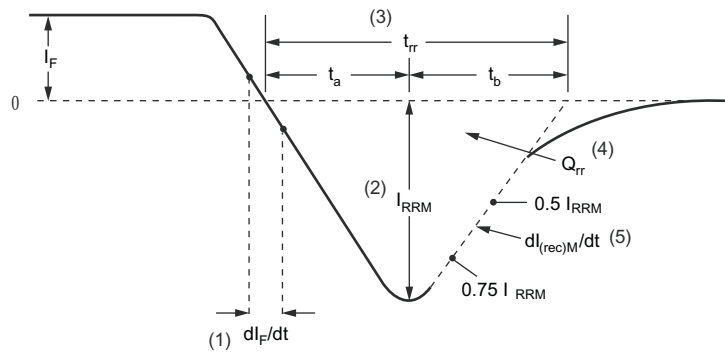

Fig.10 Reverse recovery waveform and definitions



(1) di_F/dt - rate of change of current through zero crossing

(2) I_{RRM} - peak reverse recovery current

(3) t_{rr} - reverse recovery time measured from zero crossing point of negative going I_F to point where a line passing through $0.75 I_{RRM}$ and $0.50 I_{RRM}$ extrapolated to zero current.

(4) Q_{rr} - area under curve defined by t_{rr} and I_{RRM}

$$Q_{rr} = \frac{t_{rr} \times I_{RRM}}{2}$$

(5) $di_{(rec)M}/dt$ - peak rate of change of current during t_b portion of t_{rr}

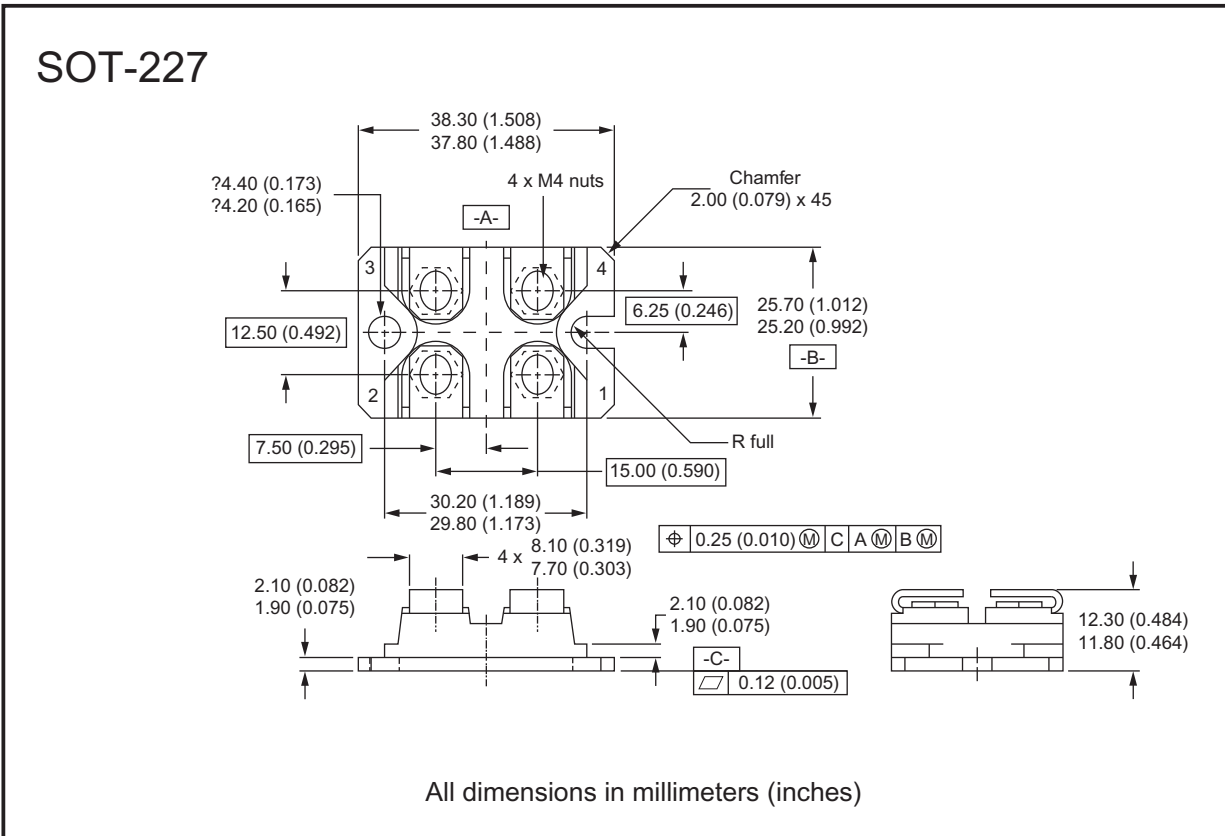

Notes

- Dimensioning and tolerancing per ANSI Y14.5M-1982
- Controlling dimension: millimeter

ORDERING INFORMATION TABLE

Device code	N	ST	120	F	60	-	A
	①	②	③	④	⑤		⑥

- ① - Nell High Power Products
- ② - Package indicator (SOT-227)
- ③ - Current rating (120 = 120A, 60A x 2)
- ④ - F = FRED family
- ⑤ - Voltage rating (60 = 600 V)
- ⑥ - Circuit type, A for Anti-Parallel type
Blank for parallel type.