

HEXFET® Power MOSFET

Applications

- High Efficiency Synchronous Rectification in SMPS
- Uninterruptible Power Supply
- High Speed Power Switching
- Hard Switched and High Frequency Circuits

Benefits

- Improved Gate, Avalanche and Dynamic dV/dt Ruggedness
- Fully Characterized Capacitance and Avalanche SOA
- Enhanced body diode dV/dt and dI/dt Capability
- Lead-Free

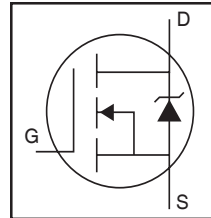

| | | |
|--------------|------|-------------|
| V_{DSS} | | 200V |
| $R_{DS(on)}$ | typ. | 64mΩ |
| | max. | 78mΩ |
| I_D | | 24A |

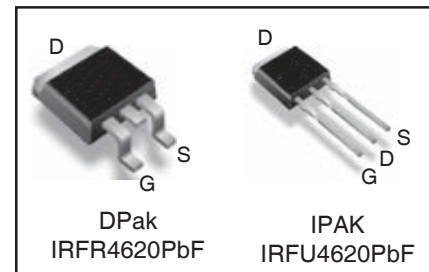

| | | |
|----------|----------|----------|
| G | D | S |
| Gate | Drain | Source |

Absolute Maximum Ratings

| Symbol | Parameter | Max. | Units |
|---------------------------------|--|--------------|-------|
| $I_D @ T_C = 25^\circ\text{C}$ | Continuous Drain Current, $V_{GS} @ 10\text{V}$ | 24 | A |
| $I_D @ T_C = 100^\circ\text{C}$ | Continuous Drain Current, $V_{GS} @ 10\text{V}$ | 17 | |
| I_{DM} | Pulsed Drain Current ① | 100 | |
| $P_D @ T_C = 25^\circ\text{C}$ | Maximum Power Dissipation | 144 | W |
| | Linear Derating Factor | 0.96 | W/°C |
| V_{GS} | Gate-to-Source Voltage | ± 20 | V |
| dv/dt | Peak Diode Recovery ③ | 54 | V/ns |
| T_J T_{STG} | Operating Junction and Storage Temperature Range | -55 to + 175 | °C |
| | Soldering Temperature, for 10 seconds (1.6mm from case) | 300 | |

Avalanche Characteristics

| | | | |
|------------------------------|---------------------------------|----------------------------|----|
| E_{AS} (Thermally limited) | Single Pulse Avalanche Energy ② | 113 | mJ |
| I_{AR} | Avalanche Current ① | See Fig. 14, 15, 22a, 22b, | A |
| E_{AR} | Repetitive Avalanche Energy ① | | mJ |

Thermal Resistance

| Symbol | Parameter | Typ. | Max. | Units |
|-----------------|-----------------------------------|------|-------|-------|
| $R_{\theta JC}$ | Junction-to-Case ⑧ | — | 1.045 | °C/W |
| $R_{\theta JA}$ | Junction-to-Ambient (PCB Mount) ⑦ | — | 50 | |
| $R_{\theta JA}$ | Junction-to-Ambient | — | 110 | |

Static @ T_J = 25°C (unless otherwise specified)

| Symbol | Parameter | Min. | Typ. | Max. | Units | Conditions |
|--------------------------------------|--------------------------------------|------|------|------|-------|--|
| V _{(BR)DSS} | Drain-to-Source Breakdown Voltage | 200 | — | — | V | V _{GS} = 0V, I _D = 250μA |
| ΔV _{(BR)DSS/ΔT_J} | Breakdown Voltage Temp. Coefficient | — | 0.23 | — | V/°C | Reference to 25°C, I _D = 5mA① |
| R _{DS(on)} | Static Drain-to-Source On-Resistance | — | 64 | 78 | mΩ | V _{GS} = 10V, I _D = 15A ④ |
| V _{GS(th)} | Gate Threshold Voltage | 3.0 | — | 5.0 | V | V _{DS} = V _{GS} , I _D = 100μA |
| I _{DSS} | Drain-to-Source Leakage Current | — | — | 20 | μA | V _{DS} = 200V, V _{GS} = 0V |
| | | — | — | 250 | | V _{DS} = 200V, V _{GS} = 0V, T _J = 125°C |
| I _{GSS} | Gate-to-Source Forward Leakage | — | — | 100 | nA | V _{GS} = 20V |
| | Gate-to-Source Reverse Leakage | — | — | -100 | | V _{GS} = -20V |
| R _{G(int)} | Internal Gate Resistance | — | 2.6 | — | Ω | |

Dynamic @ T_J = 25°C (unless otherwise specified)

| Symbol | Parameter | Min. | Typ. | Max. | Units | Conditions |
|----------------------------|---|------|------|------|-------|---|
| gfs | Forward Transconductance | 37 | — | — | S | V _{DS} = 50V, I _D = 15A |
| Q _g | Total Gate Charge | — | 25 | 38 | nC | I _D = 15A |
| Q _{gs} | Gate-to-Source Charge | — | 8.2 | — | | V _{DS} = 100V |
| Q _{gd} | Gate-to-Drain ("Miller") Charge | — | 7.9 | — | | V _{GS} = 10V ④ |
| Q _{sync} | Total Gate Charge Sync. (Q _g - Q _{gd}) | — | 17 | — | | I _D = 15A, V _{DS} = 0V, V _{GS} = 10V |
| t _{d(on)} | Turn-On Delay Time | — | 13.4 | — | ns | V _{DD} = 130V |
| t _r | Rise Time | — | 22.4 | — | | I _D = 15A |
| t _{d(off)} | Turn-Off Delay Time | — | 25.4 | — | | R _G = 7.3Ω |
| t _f | Fall Time | — | 14.8 | — | | V _{GS} = 10V ④ |
| C _{iss} | Input Capacitance | — | 1710 | — | pF | V _{GS} = 0V |
| C _{oss} | Output Capacitance | — | 125 | — | | V _{DS} = 50V |
| C _{rss} | Reverse Transfer Capacitance | — | 30 | — | | f = 1.0MHz (See Fig.5) |
| C _{oss eff. (ER)} | Effective Output Capacitance (Energy Related)⑥ | — | 113 | — | | V _{GS} = 0V, V _{DS} = 0V to 160V ⑥(See Fig.11) |
| C _{oss eff. (TR)} | Effective Output Capacitance (Time Related)⑤ | — | 317 | — | | V _{GS} = 0V, V _{DS} = 0V to 160V ⑤ |

Diode Characteristics

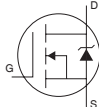
| Symbol | Parameter | Min. | Typ. | Max. | Units | Conditions |
|------------------|---|--|------|------|-------|--|
| I _S | Continuous Source Current (Body Diode) | — | — | 24 | A | MOSFET symbol showing the integral reverse p-n junction diode.  |
| I _{SM} | Pulsed Source Current (Body Diode) ① | — | — | 100 | | |
| V _{SD} | Diode Forward Voltage | — | — | 1.3 | V | T _J = 25°C, I _S = 15A, V _{GS} = 0V ④ |
| t _{rr} | Reverse Recovery Time | — | 78 | — | ns | T _J = 25°C V _R = 100V, |
| | | — | 99 | — | | T _J = 125°C I _F = 15A |
| Q _{rr} | Reverse Recovery Charge | — | 294 | — | nC | T _J = 25°C di/dt = 100A/μs ④ |
| | | — | 432 | — | | T _J = 125°C |
| I _{RRM} | Reverse Recovery Current | — | 7.6 | — | A | T _J = 25°C |
| t _{on} | Forward Turn-On Time | Intrinsic turn-on time is negligible (turn-on is dominated by LS+LD) | | | | |

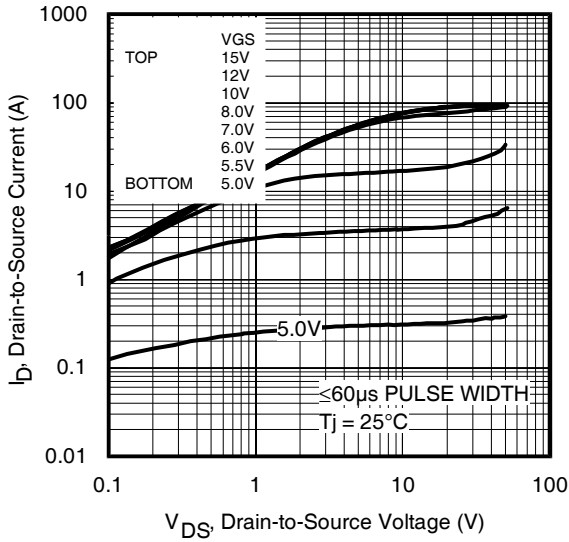

Fig 1. Typical Output Characteristics

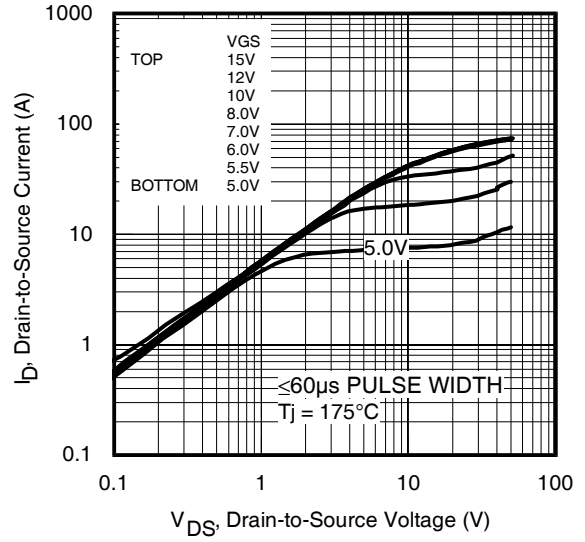

Fig 2. Typical Output Characteristics

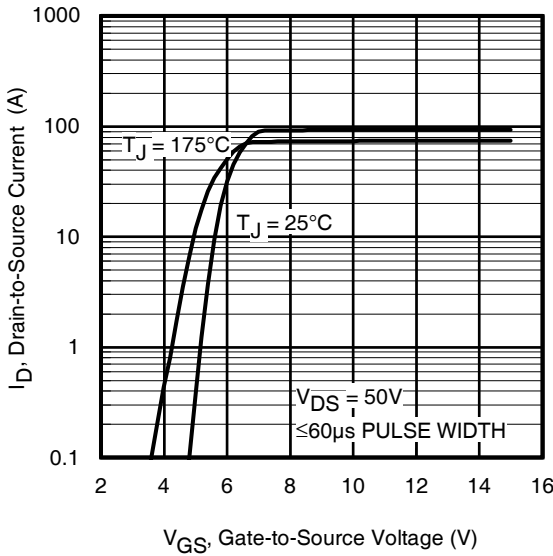

Fig 3. Typical Transfer Characteristics

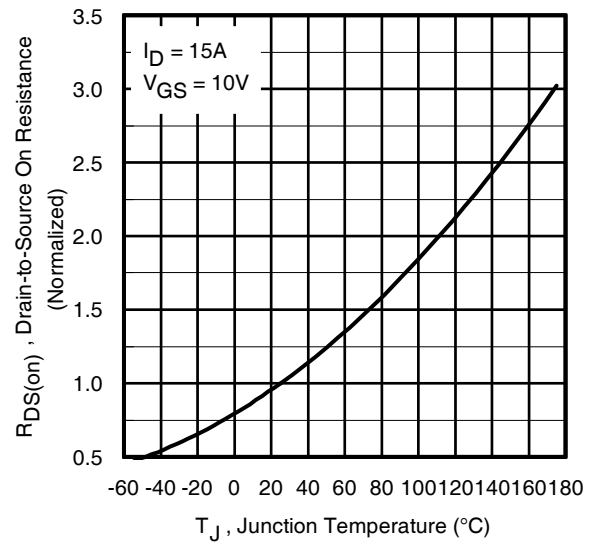

Fig 4. Normalized On-Resistance vs. Temperature

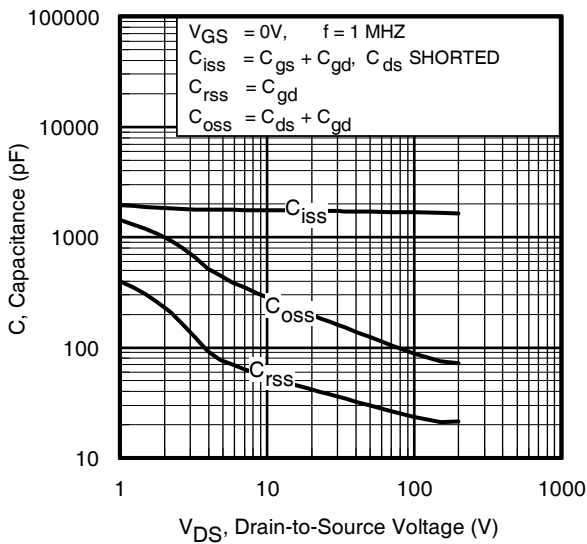

Fig 5. Typical Capacitance vs. Drain-to-Source Voltage

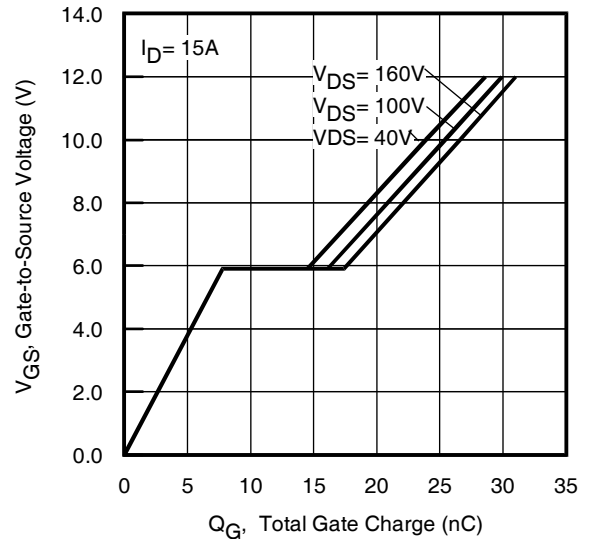

Fig 6. Typical Gate Charge vs. Gate-to-Source Voltage

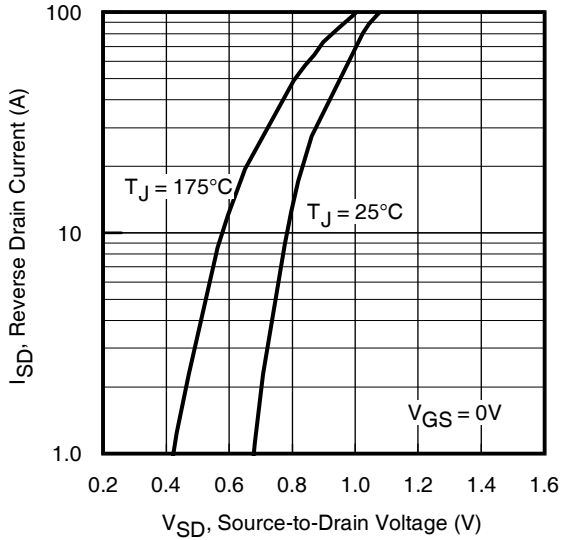

Fig 7. Typical Source-Drain Diode Forward Voltage

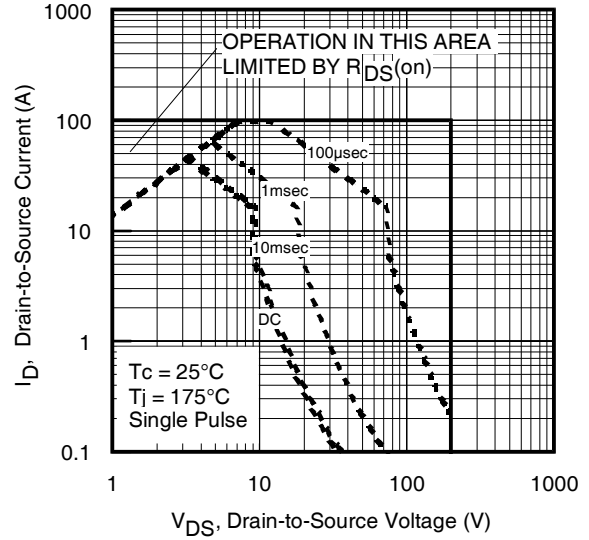

Fig 8. Maximum Safe Operating Area

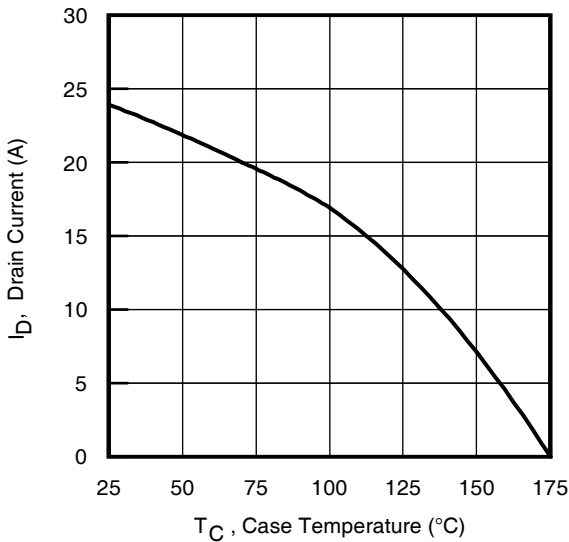

Fig 9. Maximum Drain Current vs. Case Temperature

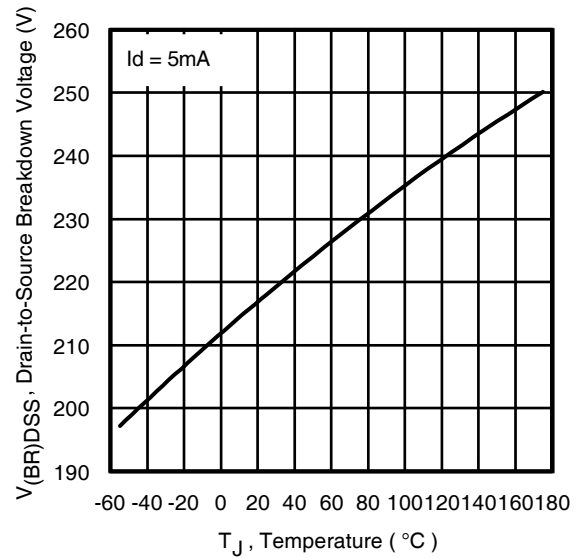

Fig 10. Drain-to-Source Breakdown Voltage

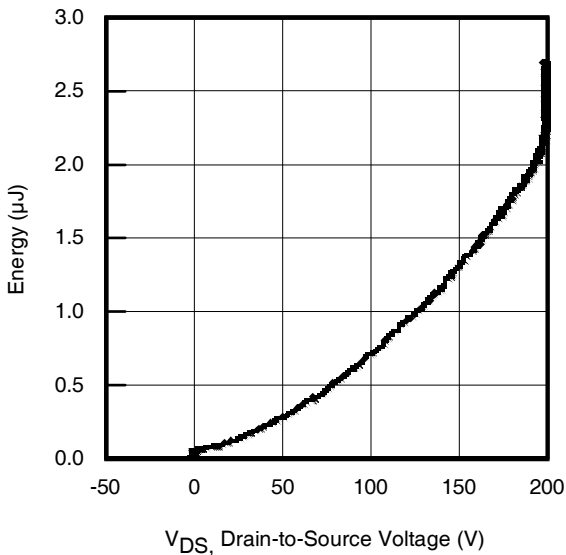

Fig 11. Typical C_{OSS} Stored Energy

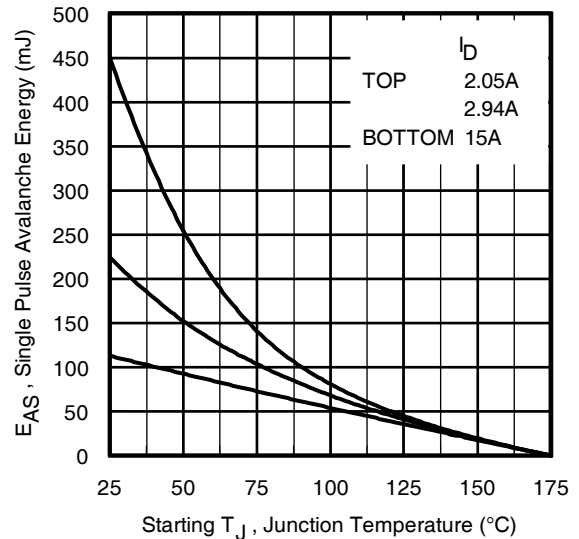

Fig 12. Maximum Avalanche Energy vs. Drain Current

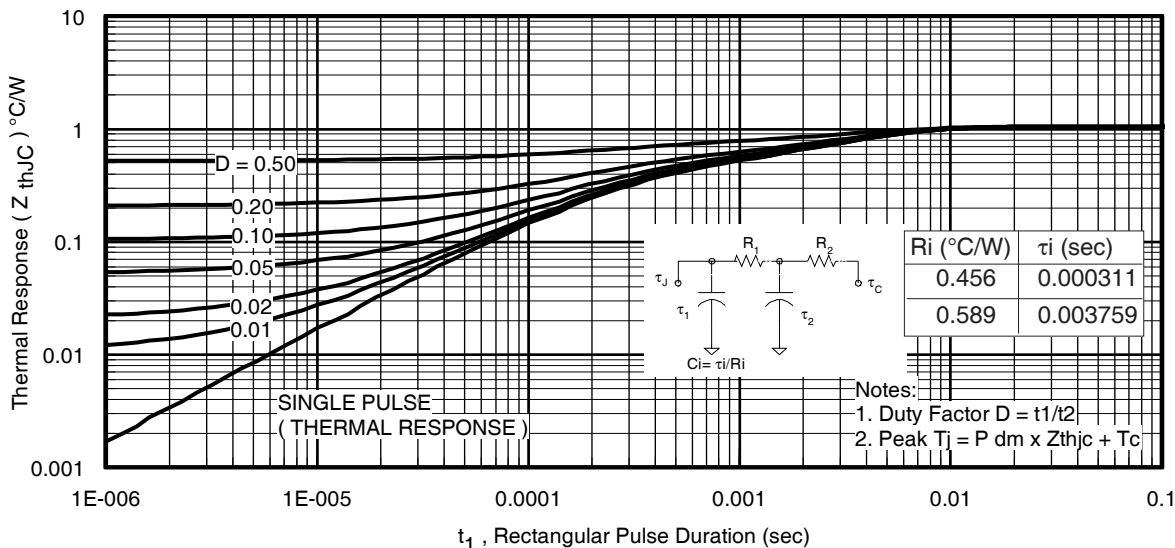

Fig 13. Maximum Effective Transient Thermal Impedance, Junction-to-Case

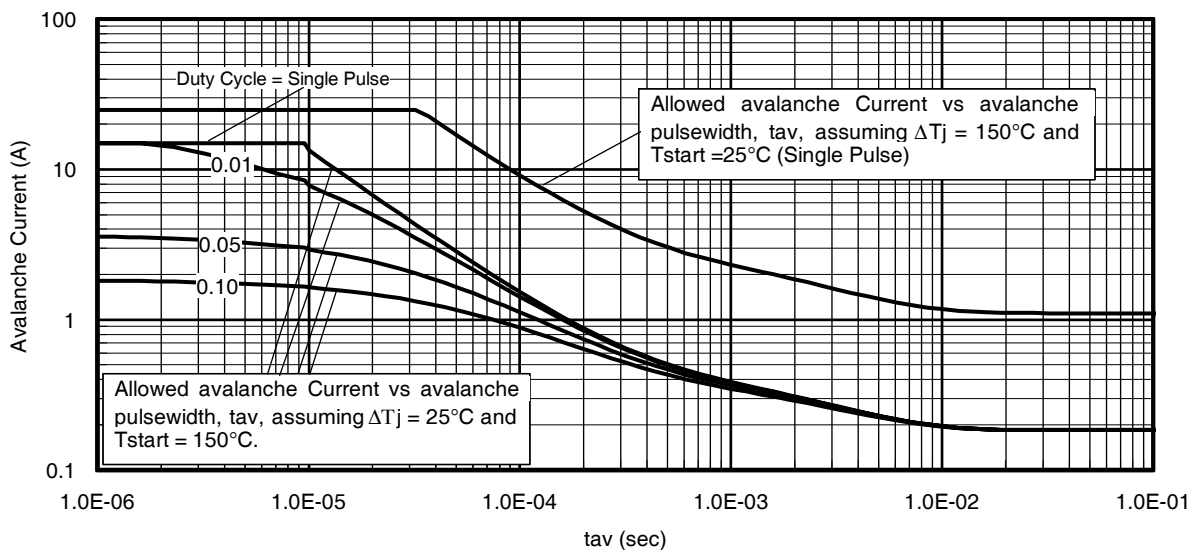
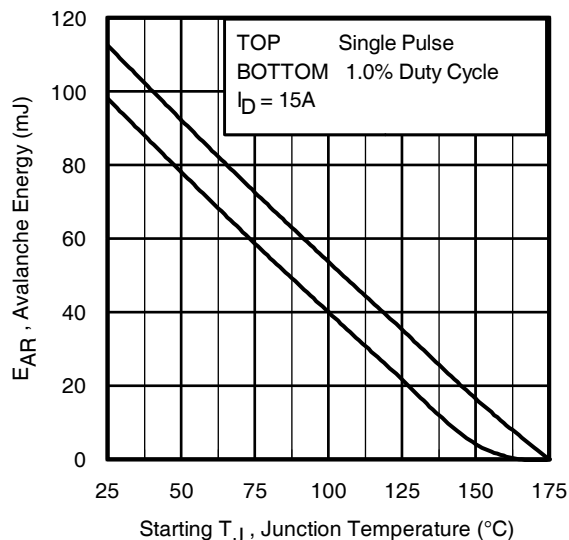

Fig 14. Typical Avalanche Current vs. Pulsewidth



Notes on Repetitive Avalanche Curves, Figures 14, 15:
(For further info, see AN-1005 at www.irf.com)

1. Avalanche failures assumption:
Purely a thermal phenomenon and failure occurs at a temperature far in excess of T_{jmax} . This is validated for every part type.
2. Safe operation in Avalanche is allowed as long as T_{jmax} is not exceeded.
3. Equation below based on circuit and waveforms shown in Figures 16a, 16b.
4. $P_{D(ave)}$ = Average power dissipation per single avalanche pulse.
5. BV = Rated breakdown voltage (1.3 factor accounts for voltage increase during avalanche).
6. I_{av} = Allowable avalanche current.
7. ΔT = Allowable rise in junction temperature, not to exceed T_{jmax} (assumed as 25°C in Figure 14, 15).
 t_{av} = Average time in avalanche.
 D = Duty cycle in avalanche = $t_{av} \cdot f$
 $Z_{thJC}(D, t_{av})$ = Transient thermal resistance, see Figures 13)

$$P_{D(ave)} = 1/2 (1.3 \cdot BV \cdot I_{av}) = \Delta T / Z_{thJC}$$

$$I_{av} = 2\Delta T / [1.3 \cdot BV \cdot Z_{th}]$$

$$E_{AS(AR)} = P_{D(ave)} \cdot t_{av}$$

Fig 15. Maximum Avalanche Energy vs. Temperature

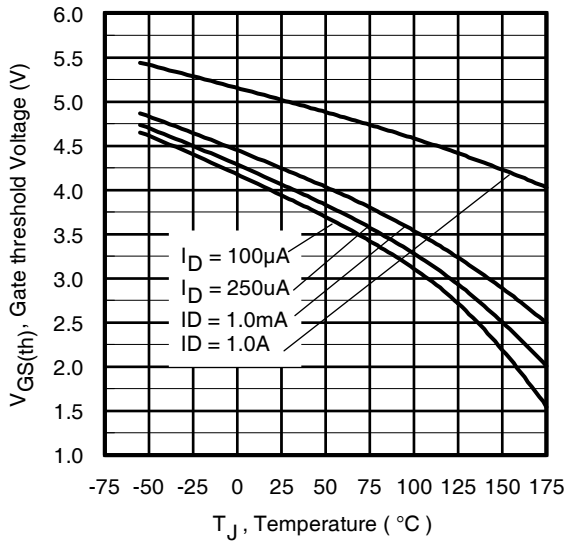

Fig. 16. Threshold Voltage vs. Temperature

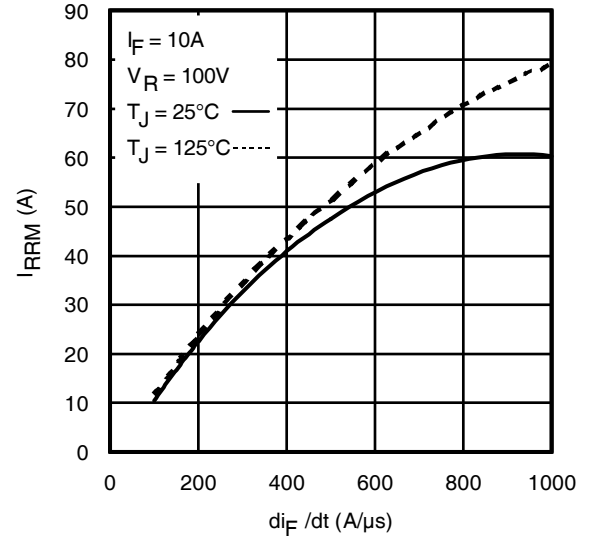

Fig. 17 - Typical Recovery Current vs. di_F/dt

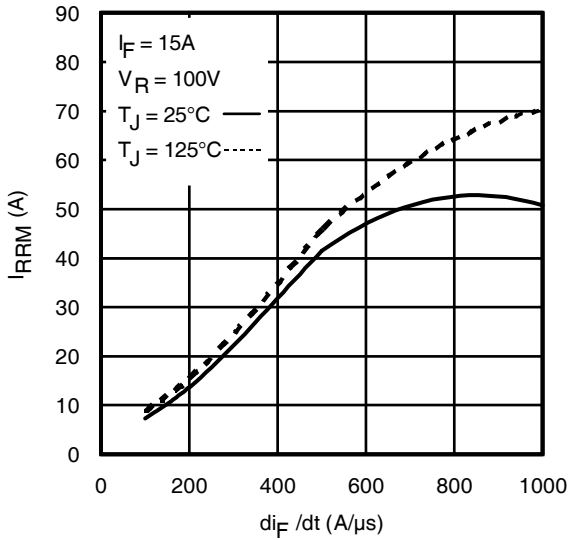

Fig. 18 - Typical Recovery Current vs. di_F/dt

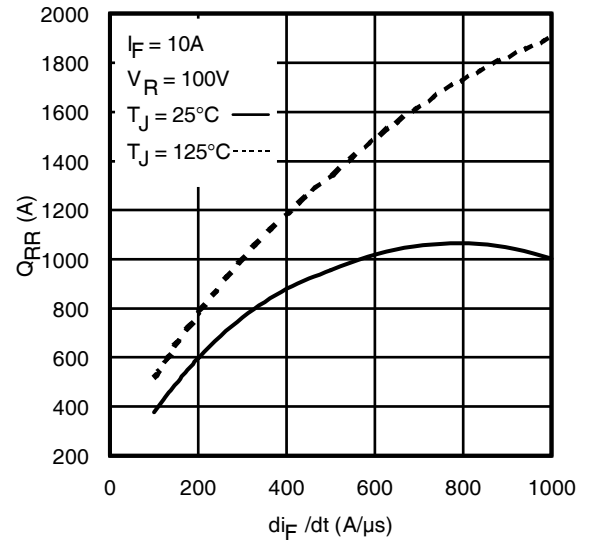

Fig. 19 - Typical Stored Charge vs. di_F/dt

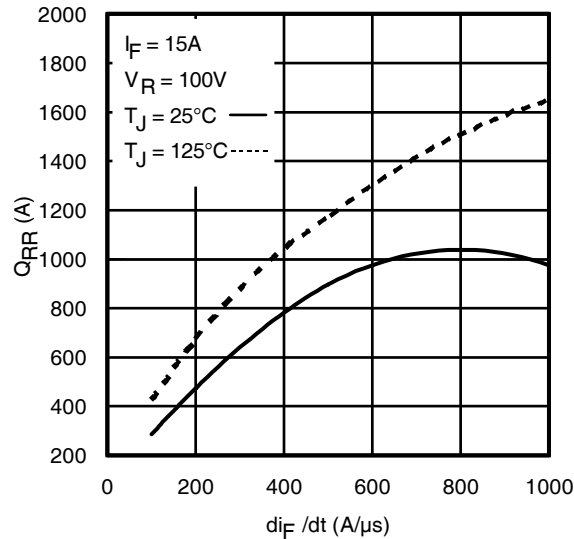

Fig. 20 - Typical Stored Charge vs. di_F/dt

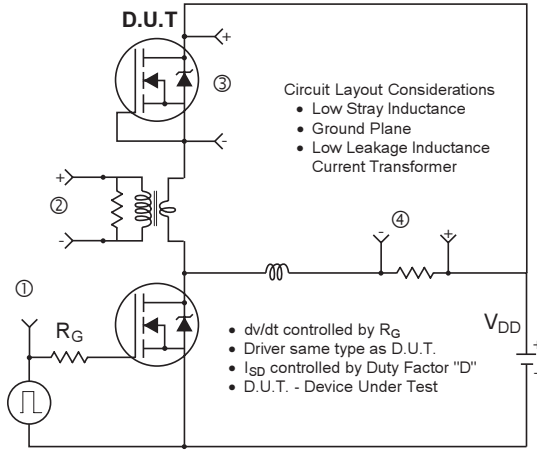
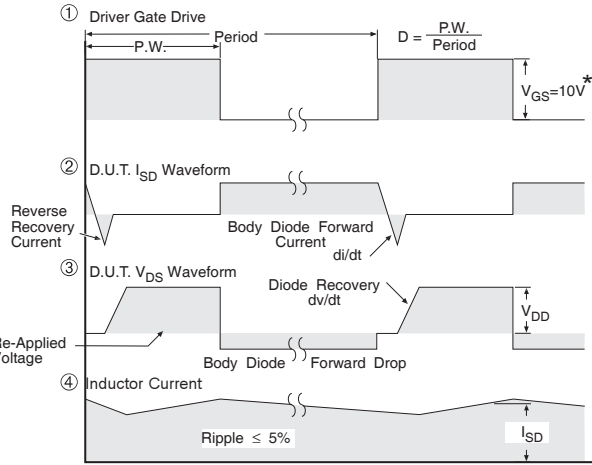

Fig 21. Peak Diode Recovery dv/dt Test Circuit for N-Channel HEXFET® Power MOSFETs



* $V_{GS} = 5V$ for Logic Level Devices

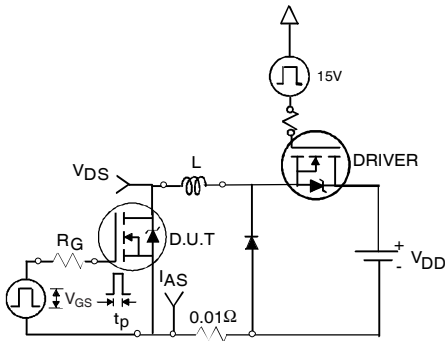

Fig 22a. Unclamped Inductive Test Circuit

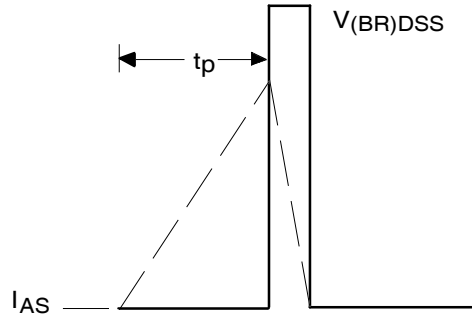

Fig 22b. Unclamped Inductive Waveforms

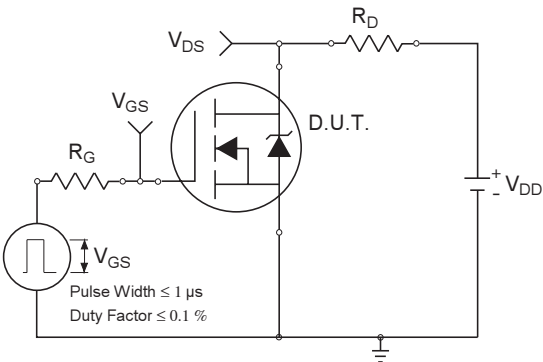

Fig 23a. Switching Time Test Circuit

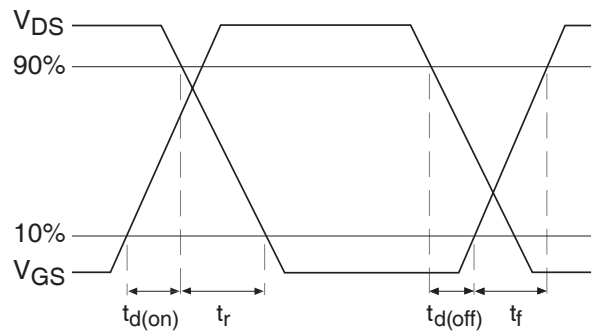

Fig 23b. Switching Time Waveforms

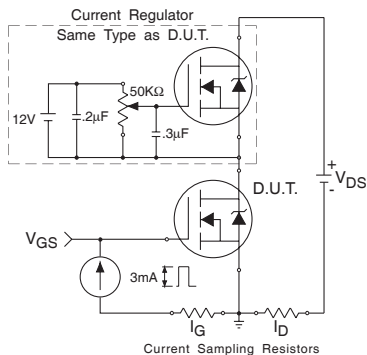

Fig 24a. Gate Charge Test Circuit

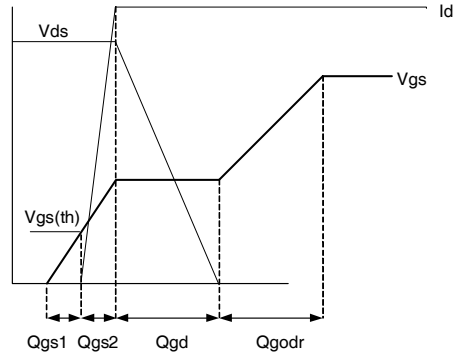
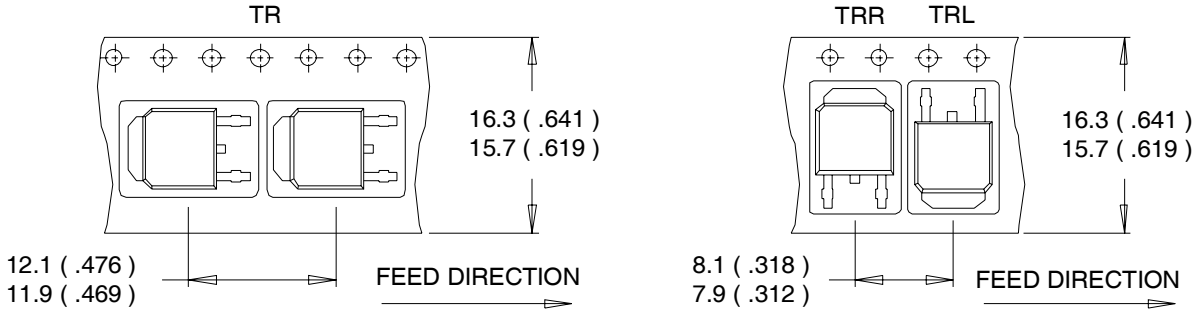

Fig 24b. Gate Charge Waveform

D-Pak (TO-252AA) Tape & Reel Information

Dimensions are shown in millimeters (inches)



NOTES :

1. CONTROLLING DIMENSION : MILLIMETER.
2. ALL DIMENSIONS ARE SHOWN IN MILLIMETERS (INCHES).
3. OUTLINE CONFORMS TO EIA-481 & EIA-541.

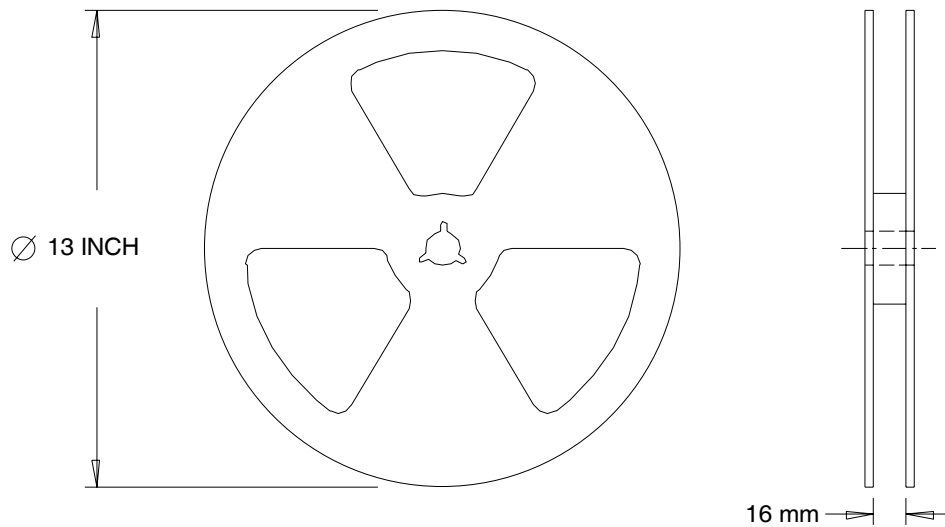

NOTES :

1. OUTLINE CONFORMS TO EIA-481.

| Orderable part number | Package Type | Standard Pack | | Note |
|-----------------------|--------------|---------------|----------|------|
| | | Form | Quantity | |
| IRFR4620PbF | D-PAK | Tube/Bulk | 75 | |
| IRFR4620TRPbF | D-PAK | Tape and Reel | 2000 | |
| IRFU4620PbF | I-PAK | Tube/Bulk | 75 | |

Qualification Information[†]

| | | |
|----------------------------|--|--|
| Qualification level | Industrial ^{††} | |
| | (per JEDEC JESD47F ^{†††} guidelines) | |
| | Comments: This family of products has passed JEDEC's Industrial qualification. IR's Consumer qualification level is granted by extension of the higher Industrial level. | |
| Moisture Sensitivity Level | D-PAK | MSL1 (per JEDEC J-STD-020D ^{†††}) |
| | I-PAK | Not applicable |
| RoHS Compliant | Yes | |

Notes:

- ① Repetitive rating; pulse width limited by max. junction temperature.
- ② Limited by T_{Jmax} , starting $T_J = 25^\circ\text{C}$, $L = 1.0\text{mH}$
 $R_G = 25\Omega$, $I_{AS} = 15\text{A}$, $V_{GS} = 10\text{V}$. Part not recommended for use above this value .
- ③ $I_{SD} \leq 15\text{A}$, $di/dt \leq 634\text{A}/\mu\text{s}$, $V_{DD} \leq V_{(BR)DSS}$, $T_J \leq 175^\circ\text{C}$.
- ④ Pulse width $\leq 400\mu\text{s}$; duty cycle $\leq 2\%$.
- ⑤ C_{oss} eff. (TR) is a fixed capacitance that gives the same charging time as C_{oss} while V_{DS} is rising from 0 to 80% V_{DSS} .
- ⑥ C_{oss} eff. (ER) is a fixed capacitance that gives the same energy as C_{oss} while V_{DS} is rising from 0 to 80% V_{DSS} .
- ⑦ When mounted on 1" square PCB (FR-4 or G-10 Material). For recommended footprint and soldering techniques refer to application note #AN-994.
- ⑧ R_θ is measured at T_J approximately 90°C