

5-4000 MHz Wideband Drive Amplifier

Device Features

- 43.5 dBm Output IP3 at 9dBm/tone
- 22 dB Gain at 900MHz
- 24 dBm P1dB at 2450 MHz
- Highly Reliable InGaP/GaAs HBT Technology
- Application: commercial wireless system

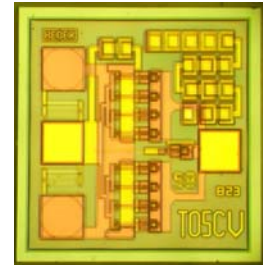

Target Device Performance ($T_a = 25^\circ\text{C}$)

Symbols	Parameters Test Conditions	Min	Typ	Max	Unit
Gain	900MHz	20.7	21.7	22.7	dB
	1900MHz	16.6	17.6	18.6	
	2450MHz	14.3	15.3	16.3	
S11	900MHz		-18.6		dB
	1900MHz		-15.3		
	2450MHz		-17.2		
S22	900MHz		-15.1		dB
	1900MHz		-39.7		
	2450MHz		-15.3		
OIP3	900MHz	41.6	43.6		dBm
	1900MHz	41.3	42.3		
	2450MHz	39.7	40.7		
P1dB	900MHz	23.0	24.0		dBm
	1900MHz	22.8	23.8		
	2450MHz	23.2	24.2		
IS-95 CH Power @-45dBc ACPR	900MHz		16.0		dBm
	1900MHz		16.0		
	2450MHz		16.5		
NF	900MHz		4.4		dB
	1900MHz		4.2		
	2450MHz		4.3		
Ic	$V_c = 5.0V$	77	87	97	mA
Vc			5.0		V
Rth	Thermal Resistance		50		$^\circ\text{C}/\text{W}$

Test conditions unless otherwise noted.

1. Device performance is measured on BeRex evaluation board at 25C, 50 ohm system
2. OIP3 is measured on an eval-board with two tones separated by 1 MHz.

Absolute Maximum Ratings

Parameter	Rating
Operating Case temperature	-40 to +85 $^\circ\text{C}$
Storage Temperature	-55 to +155 $^\circ\text{C}$
Supply Voltage	6.5V
Max. Device Current	180mA
Input RF Power	23dBm

Operation of this device above any of these parameters may result in permanent damage.

Typical Device Data

S-parameters ($V_c=5V$, $I_c=87mA$, $T=25^\circ C$)

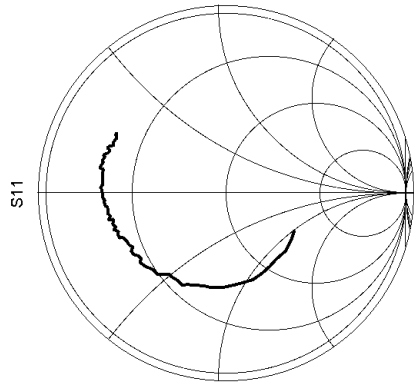

freq (50.00MHz to 3.950GHz)

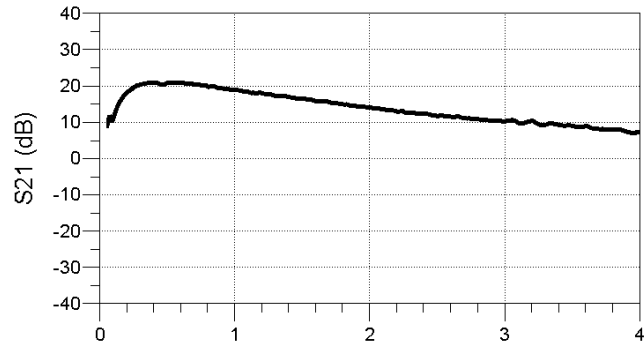

Freq. (GHz)

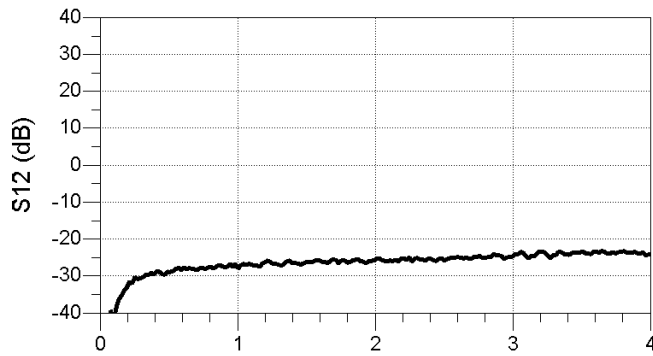

Freq. (GHz)

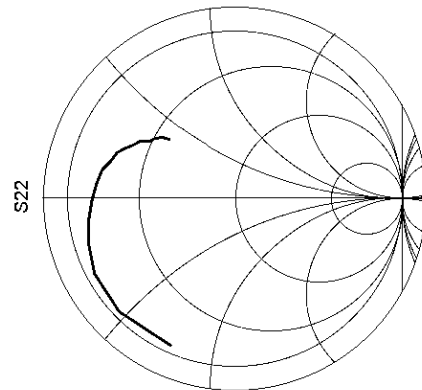

freq (50.00MHz to 3.950GHz)

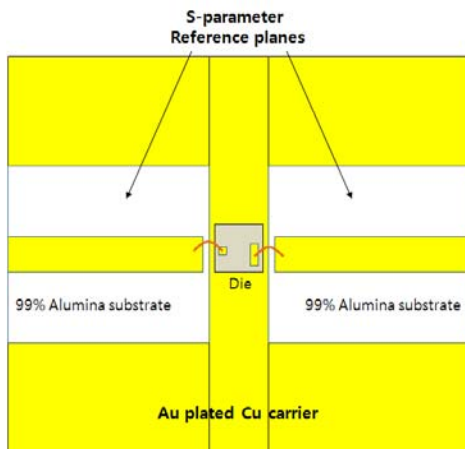

S-parameter test circuit

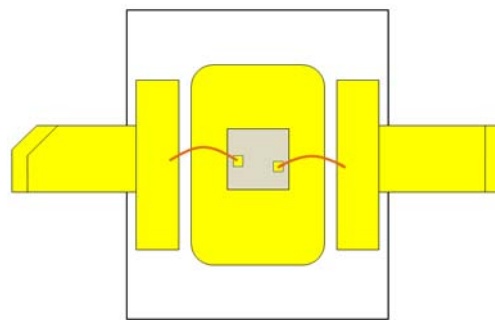

Chip attachment on PF083

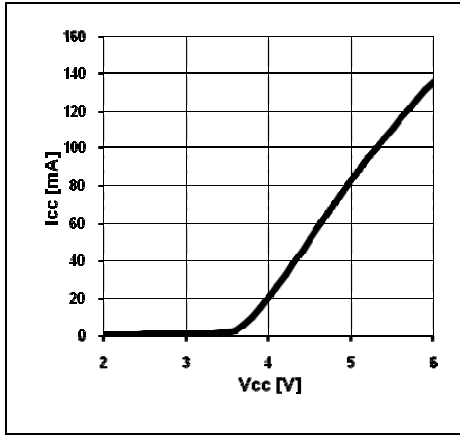

I-V characteristics

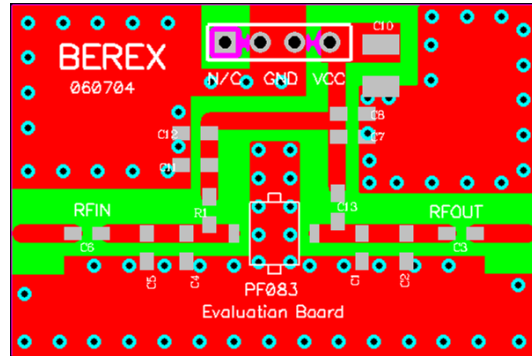

Generic PF083 Evaluation Board
(31mil thick FR4)

**S-Parameter
(5V/87mA)**

Freq [MHz]	S11 [Mag]	S11 [Ang]	S12 [Mag]	S12 [Ang]	S21 [Mag]	S21 [Ang]	S22 [Mag]	S22 [Ang]
100	0.465	-48.427	0.010	85.919	3.827	-99.799	0.929	-153.159
500	0.645	-128.468	0.034	7.967	9.952	141.528	0.602	144.177
1000	0.690	-171.254	0.045	-48.963	8.810	48.139	0.315	148.430
1500	0.748	159.059	0.051	-102.372	6.588	-24.785	0.376	144.485
2000	0.778	141.185	0.053	-144.526	4.794	-81.488	0.455	138.017
2500	0.748	138.006	0.055	172.951	3.889	-135.293	0.418	142.841
3000	0.841	142.443	0.059	130.929	3.046	176.260	0.541	154.681
3500	0.934	139.011	0.056	84.638	2.464	127.419	0.638	149.921
4000	0.899	132.888	0.067	40.623	2.301	75.436	0.591	143.868

* Note : S-parameter includes 1 mil thick and 16-mil long Au wire

Application Circuit: 900 MHz

Schematic Diagram	BOM	Tolerance
	C1	100pF ± 5%
	C2	6.8pF ±5%
	C3	100pF ± 5%
	C4	100pF ± 5%
	C5	1000pF ± 10%
	C6	10uF ±10%
	L1	2nH ±5%
	L2	12nH ± 5%

Typical Performance

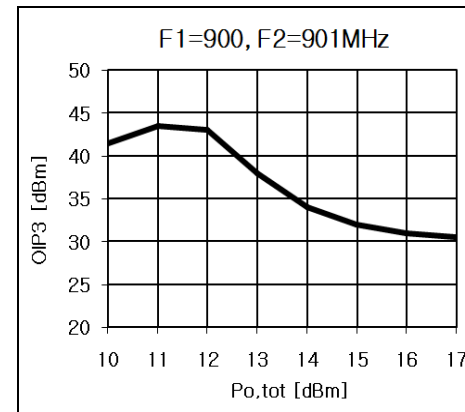
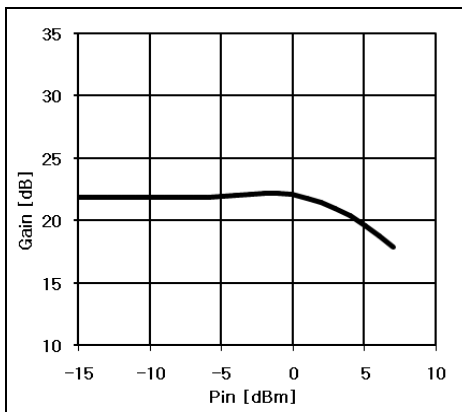
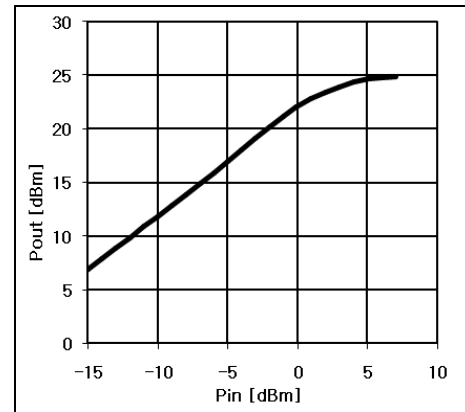
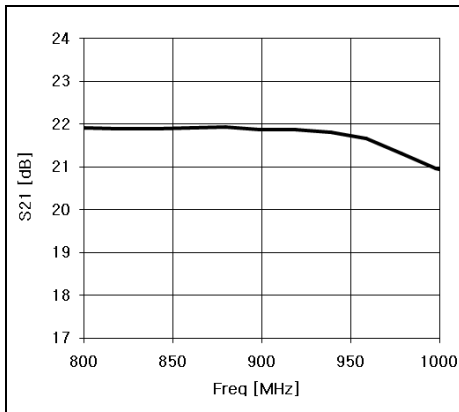
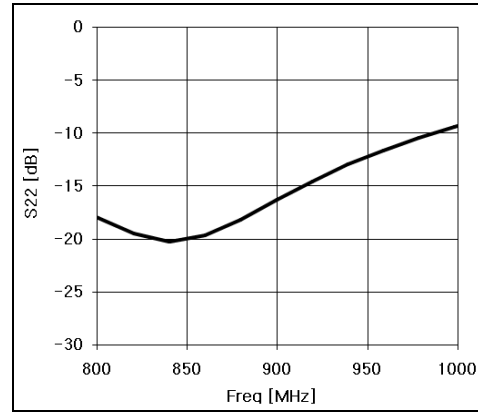
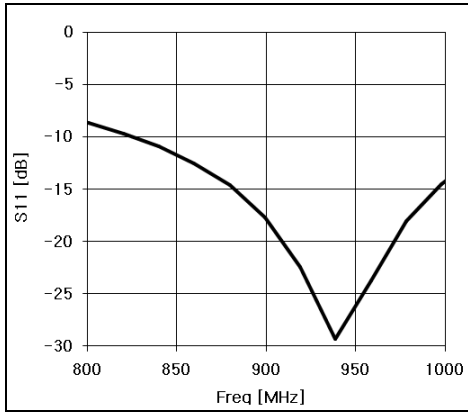

Application Circuit: 1900 MHz

Schematic Diagram	BOM	Tolerance	
	C1	100pF	± 5%
	C2	2pF	±5%
	C3	1.2pF	±5%
	C4	100pF	± 5%
	C5	100pF	± 5%
	C6	1000pF	± 10%
	C7	10uF	±10%
	L1	1.8nH	±5%
L2	6.8nH	± 5%	

Typical Performance

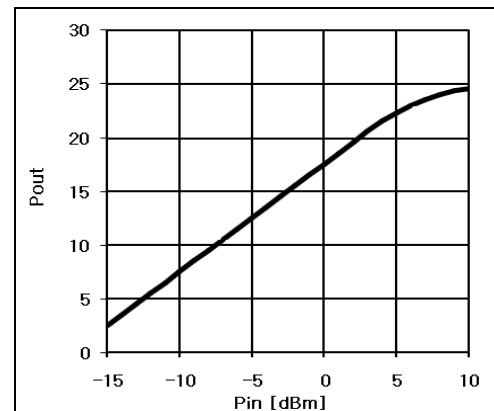
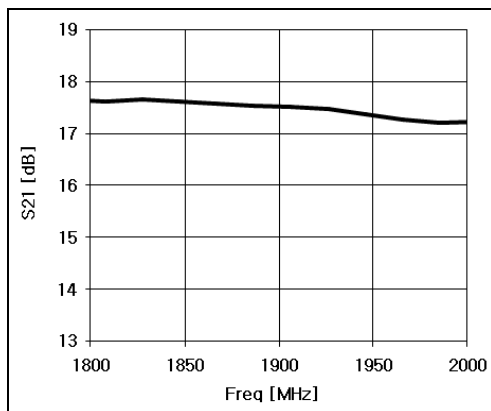
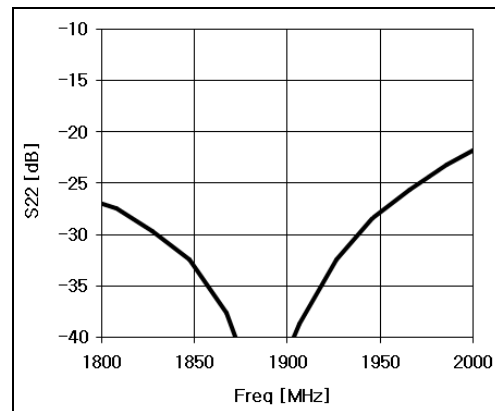
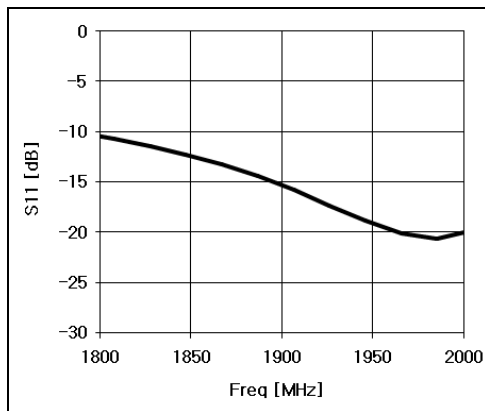

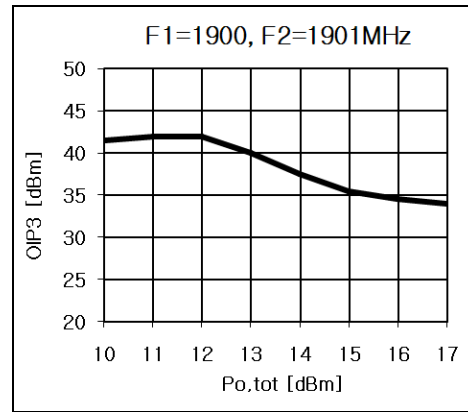
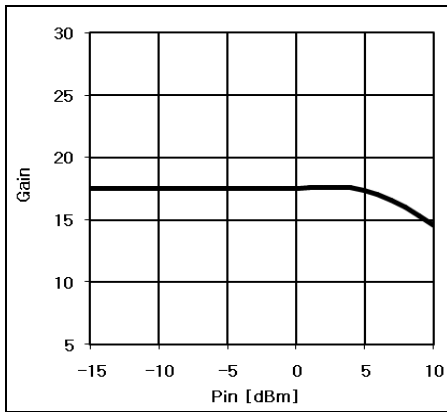

Application Circuit: 2450MHz

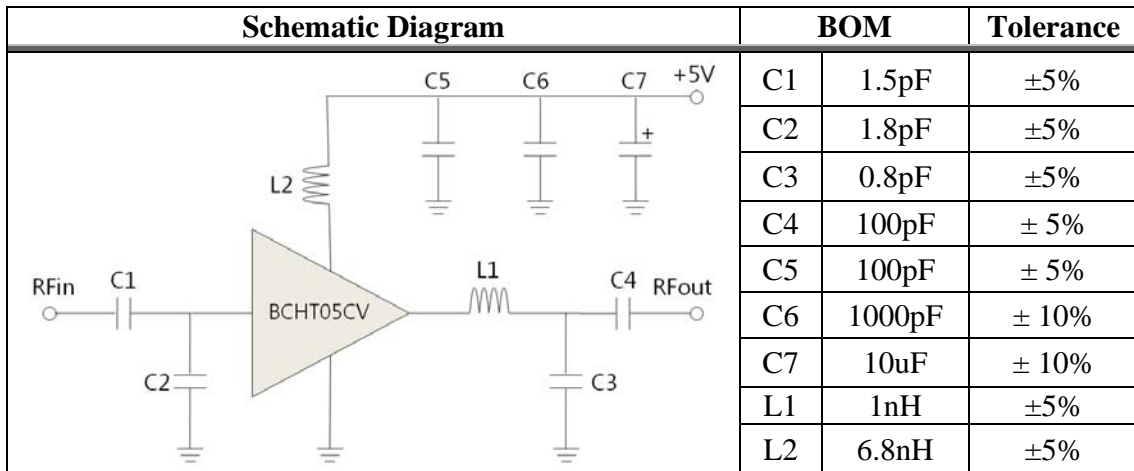

Typical Performance

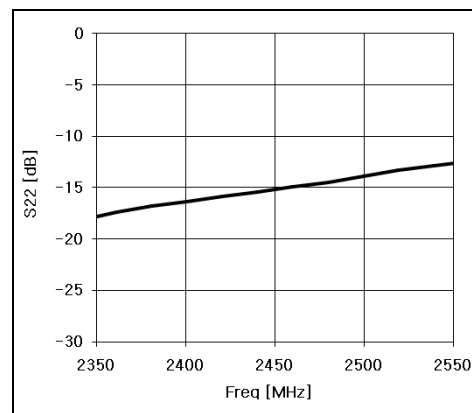
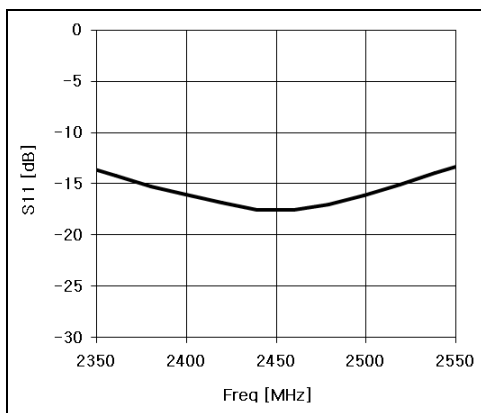

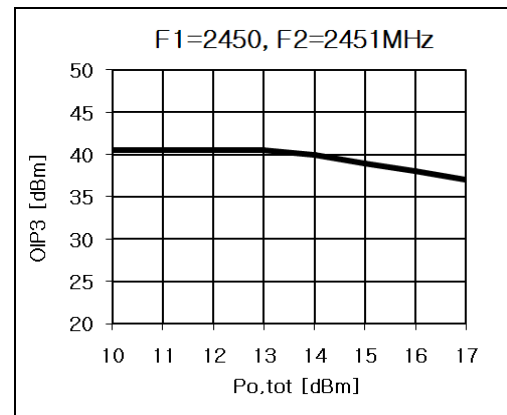
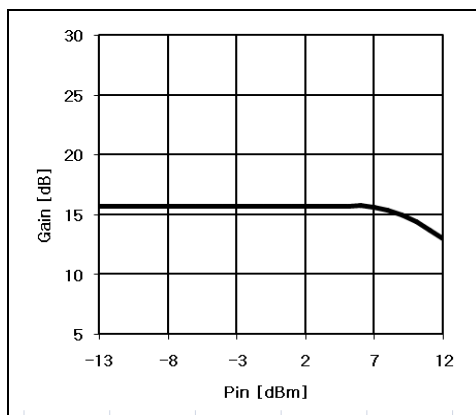
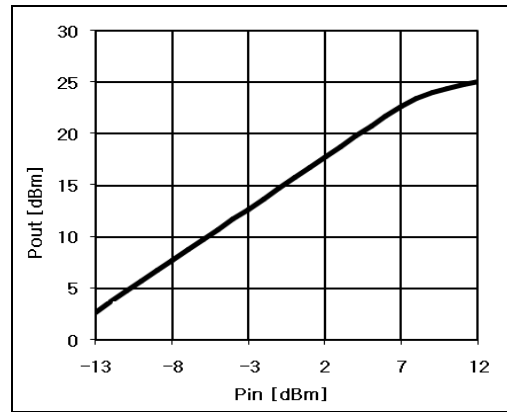
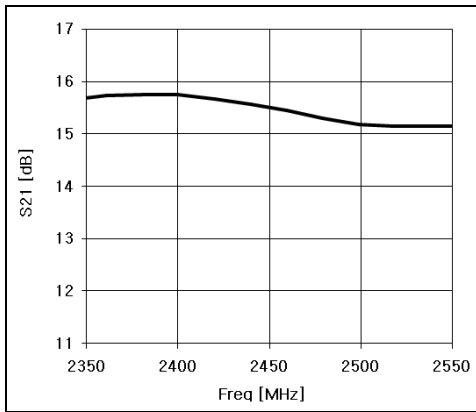

Die Outline

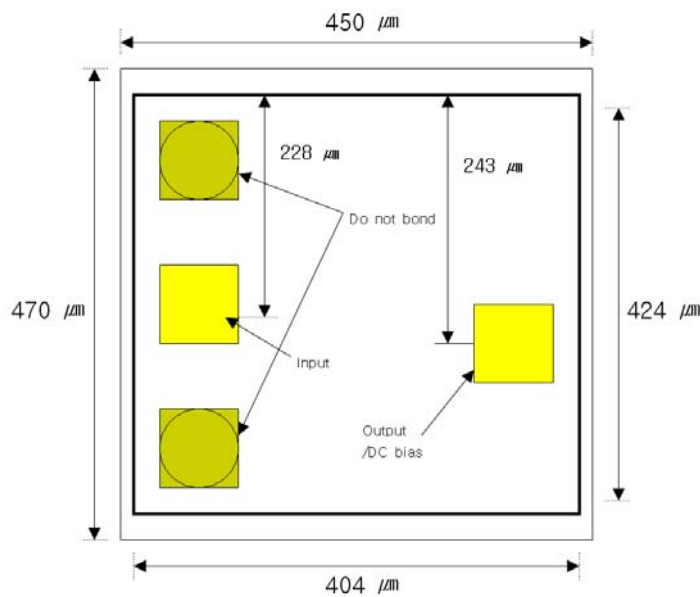

NOTES:

- 1) DIE THICKNESS 100um
- 2) BONDPAD METAL THICKNESS 2.8um
- 3) BACKSIDE METAL Au, 5um
- 4) DEVICE IS GROUNDED THROUGH VIA HOLES

ESD Rating

ESD Rating	Class 1B
Value	Passes <1000V
Test	Human Body Model (HBM)
Standard	JEDEC Standard JESD22-A114B

NATO CAGE code:

2	N	9	6	F
----------	----------	----------	----------	----------

NOTICE

BeRex Corporation reserves the right to make changes of product specification or to discontinue product at any time without notice.



Proper ESD procedures should be followed when handling this device.