

PART CHARACTERISTICS		
NUMBER OF POSITION	ASSEMBLY ITEM NUMBER	MATERIAL
02	43025-0200	'B'
04	43025-0400	
06	43025-0600	
08	43025-0800	
10	43025-1000	
12	43025-1200	
14	43025-1400	
16	43025-1600	
18	43025-1800	
20	43025-2000	
22	43025-2200	
24	43025-2400	
		'A'

CKT. NO.	DIM. 'A'	DIM. 'B'
2	.152/(3.86)	N/A
4	.270/(6.85)	.118/(3.00)
6	.388/(9.85)	.236/(6.00)
8	.506/(12.85)	.354/(9.00)
10	.624/(15.85)	.472/(12.00)
12	.742/(18.85)	.591/(15.00)
14	.860/(21.85)	.709/(18.00)
16	.978/(24.85)	.827/(21.00)
18	1.096/(27.85)	.945/(24.00)
20	1.215/(30.85)	1.063/(27.00)
22	1.333/(33.85)	1.181/(30.00)
24	1.451/(36.85)	1.299/(33.00)

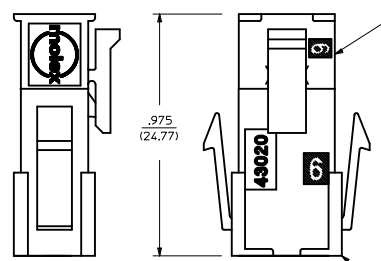

MATED MICRO-FIT CONNECTOR

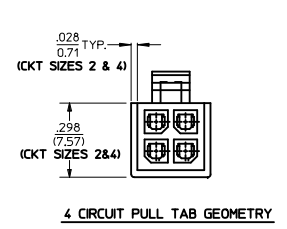
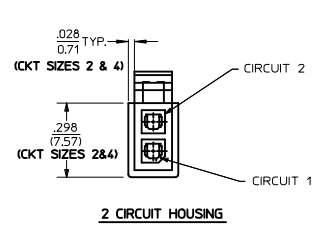
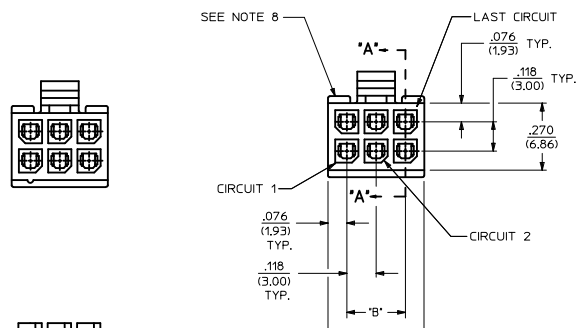
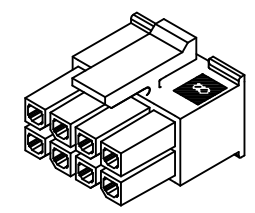
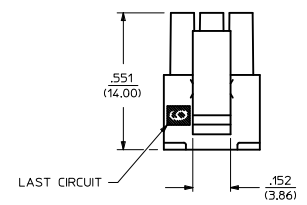
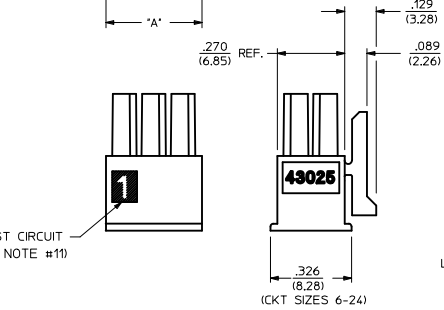
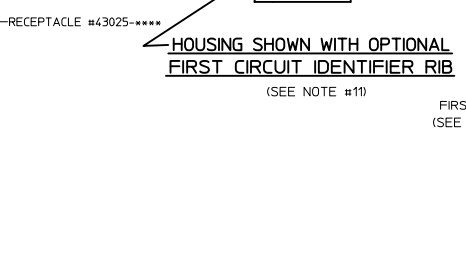

RECEPTACLE ISO VIEW (8 CIRCUIT SHOWN) (SEE NOTE 9 FOR TESTING)

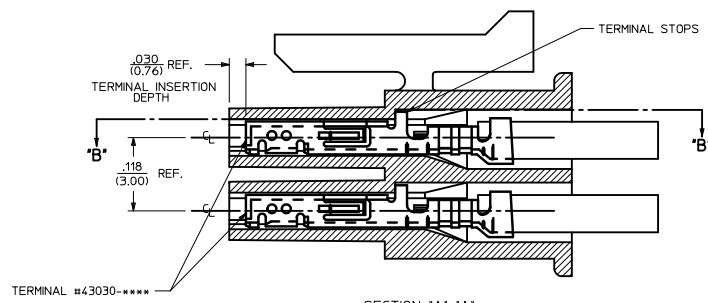

SECTION "A"- "A" WITH TERMINAL (SCALE 10:1)

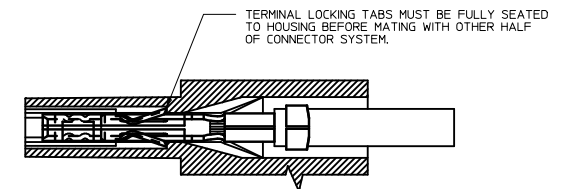

SECTION "B"- "B" (SCALE 10:1)

NOTES:

- HOUSING MATERIAL:
 'A' - UNFILLED POLYESTER, RATED UL, 94V-0, COLOR IS BLACK.
 'B' - UNFILLED NYLON 6, RATED UL, 94V-0, HALOGEN-FREE AND IEC 60335-1, 4TH EDITION GLOW WIRE CAPABLE, COLOR IS BLACK.
 * MATERIAL 'B' PARTS ARE IDENTIFIED WITH A GREEN LABEL OR A GREEN DOT ON A WHITE LABEL, PART NUMBERS LISTED AS 'B' MATERIAL BUT MANUFACTURED PRIOR TO 8/30/2010 OR NOT CONTAINING THIS 'GREEN' IDENTIFICATION MAY BE MATERIAL 'A'.
- FINISH: N/A
- PRODUCT SPECIFICATION: PS-43045
- PACKAGING SPECIFICATION: PK-43025-001
- THIS RECEPTACLE MATES WITH 43020, 43045.
- THIS RECEPTACLE TO BE USED WITH MOLEX FEMALE TERMINAL #43030-****. SEE SECTION 'A'-'A' FOR TERMINAL ORIENTATION IN HOUSING.
- FOR OVERMOLDING PARAMETERS SEE ENGINEERING SPECIFICATION #SDS-43025-1000.
- TOP PULL TABS ARE NOT AVAILABLE ON 2 AND 4 CIRCUIT PARTS.
- MOLEX RECOMMENDS THE USE OF MICRO-FIT TEST PLUG, SERIES NO. 44242-**** WHENEVER TESTING IS PERFORMED. TEST PLUGS MUST NOT BE USED FOR MAKE OR BREAK UNDER LOAD. MOLEX DOES NOT RECOMMEND USING STANDARD MATING COMPONENTS FOR HARNESS TESTING PURPOSES.
- SOME HOUSINGS MAY HAVE A SMALL GATE BLEMISH NEAR THE GATE THAT DOES NOT AFFECT FUNCTIONALITY.
- HOUSINGS MAY HAVE EITHER AN IDENTIFIER RIB OR "1" SYMBOL ENGRAVE TO INDICATE CIRCUIT #1.
- THIS PART CONFORMS TO CLASS 'B' REQUIREMENTS OF COSMETIC SPECIFICATION PS-45499-002.

ADD NYLON MATL IEC NO: UCP2011-0916 (DIPKINGMARRANI 2010/09/30) (CHIKOSUSEK 2010/09/30) APPROVED WITH	QUALITY SYMBOLS	GENERAL TOLERANCES (UNLESS SPECIFIED)	DIMENSION STYLE	SCALE	DESIGN UNITS	THIRD ANGLE PROJECTION
	▽=0	4 PLACES ± --- ± ---	IN/MM	4:1	METRIC	
	▽=0	3 PLACES ± --- ± .010				
	▽=0	2 PLACES ± 0.25 ± .014				
		1 PLACE ± 0.35 ± ---				
		ANGULAR ±1/2°				
	DRAFT WHERE APPLICABLE MUST REMAIN WITHIN DIMENSIONS	SEE CHART		MOLEX INCORPORATED		
		MATERIAL NO. SDA-43025-****		SHEET NO. 1 OF 1		
		THIS DRAWING CONTAINS INFORMATION THAT IS PROPRIETARY TO MOLEX INCORPORATED AND SHOULD NOT BE USED WITHOUT WRITTEN PERMISSION				