

**Silicon N-Channel MOSFET**

**Features**

- 68A,60V,  $R_{DS(on)}$ (Max18m $\Omega$ )@ $V_{GS}=10V$
- Ultra-low Gate charge(Typical 20nC)
- Improved dv/dt capability
- 100%Avalanche Tested
- Maximum Junction Temperature Range(175 $^{\circ}C$ )

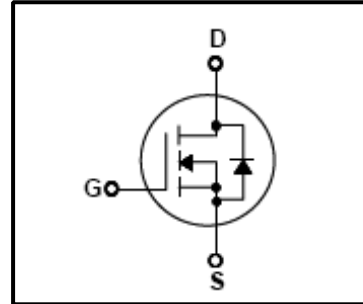

**General Description**

This Power MOSFET is produced using Winsemi's advanced planar stripe,DMOS technology.This latest technology has been especially designed to minimize on-state resistance, have a low gate charge with superior switching performance, and rugged avalanche characteristics,DC-DC Converters and power management in portable and,battery operated products.

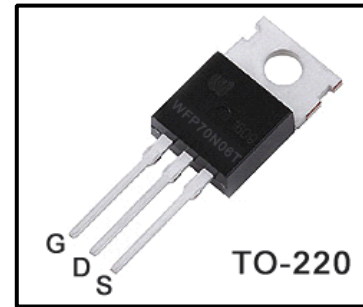

**Absolute Maximum Ratings**

Symbol	Parameter	Value	Units
$V_{DSS}$	Drain Source Voltage	60	V
$I_D$	Continuous Drain Current(@ $T_c=25^{\circ}C$ )	68	A
	Continuous Drain Current(@ $T_c=100^{\circ}C$ )	51	A
$I_{DM}$	Drain Current Pulsed (Note1)	280	A
$V_{GS}$	Gate to Source Voltage	$\pm 25$	V
$E_{AS}$	Single Pulsed Avalanche Energy (Note2)	800	mJ
dv/dt	Peak Diode Recovery dv /dt (Note3)	7.0	V/ ns
$P_D$	Total Power Dissipation(@ $T_c=25^{\circ}C$ )	115	W
	Derating Factor above 25 $^{\circ}C$	0.77	W/ $^{\circ}C$
$T_J, T_{stg}$	Junction and Storage Temperature	-55~175	$^{\circ}C$
$T_L$	Maximum Lead Temperature for soldering purpose, 1/8 form Case for 5 seconds	300	$^{\circ}C$

**Thermal Characteristics**

Symbol	Parameter	Value			Units
		Min	Typ	Max	
$R_{QJC}$	Thermal Resistance , Junction -to -Case	-	-	1.3	$^{\circ}C/W$
$R_{QCS}$	Thermal Resistance , Case-to-Sink	-	0.5	-	$^{\circ}C/W$
$R_{QJA}$	Thermal Resistance , Junction-to -Ambient	-	-	62.5	$^{\circ}C/W$

## Electrical Characteristics(Tc=25°C)

Characteristics	Symbol	Test Condition	Min	Typ	Max	Unit	
Gate leakage current	I <sub>GSS</sub>	V <sub>GS</sub> =±20V,V <sub>DS</sub> =0V	-	-	±100	nA	
Drain cut -off current	I <sub>DSS</sub>	V <sub>DS</sub> =48V,V <sub>GS</sub> =0V	-	-	1	μA	
		V <sub>DS</sub> =48V,V <sub>GS</sub> =0V,T <sub>J</sub> =125°C			100		
Drain -source breakdown voltage	V <sub>(BR)DSS</sub>	I <sub>D</sub> =250 μA,V <sub>GS</sub> =0V	60	-	-	V	
Breakdown voltage Temperature Coefficient	ΔBV <sub>DSS</sub> /ΔT <sub>J</sub>	I <sub>D</sub> =250μA,Referenced to 25°C	-	0.066	-	V/°C	
Gate threshold voltage	V <sub>GS(th)</sub>	V <sub>DS</sub> =V <sub>GS</sub> ,I <sub>D</sub> =250 μA	2.0	-	4.0	V	
Drain -source ON resistance	R <sub>DS(ON)</sub>	V <sub>GS</sub> =10V,I <sub>D</sub> =35A	-	-	18	mΩ	
Input capacitance	C <sub>iss</sub>	V <sub>DS</sub> =25V,	-	1088		pF	
Reverse transfer capacitance	C <sub>rss</sub>	V <sub>GS</sub> =0V,	-	67			
Output capacitance	C <sub>oss</sub>	f=1MHz	-	158			
Switching time	Rise time	t <sub>r</sub>	V <sub>DD</sub> =30V, I <sub>D</sub> =1A V <sub>G</sub> =10V R <sub>G</sub> =50Ω  (Note4,5)	-	45.1		ns
	Turn-in Delay time	T <sub>d(on)</sub>		-	8.7		
	Fall time	t <sub>f</sub>		-	6.8		
	Turn-off Delay time	T <sub>d(off)</sub>		-	25.6		
Total gate charge(gate-source plus gate-drain)	Q <sub>g</sub>	V <sub>DD</sub> =30V, V <sub>GS</sub> =10V,	-	20		nC	
Gate-source charge	Q <sub>gs</sub>	I <sub>D</sub> =1A	-	7	-		
Gate-drain("miller") Charge	Q <sub>gd</sub>	(Note4,5)	-	6.8	-		

## Source-Drain Ratings and Characteristics(Ta=25°C)

Characteristics	Symbol	Test Condition	Min	Type	Max	Unit
Continuous drain reverse current	I <sub>DR</sub>	Integral Reverse p-n Junction	-	-	68	A
Pulse drain reverse current	I <sub>DRP</sub>	Diode in the MOSFET	-	-	280	A
Forward voltage(diode)	V <sub>DSF</sub>	I <sub>DR</sub> =50A,V <sub>GS</sub> =0V	-	-	1.2	V
Reverse recovery time	t <sub>rr</sub>	I <sub>DR</sub> =68A,V <sub>GS</sub> =0V,	-	62	-	ns
Reverse recovery charge	Q <sub>rr</sub>	dI <sub>DR</sub> / dt =100 A / μs	-	110	-	μC

Note 1.Repeativity rating :pulse width limited by junction temperature

2.L=250uH I<sub>AS</sub>=68A,V<sub>DD</sub>=25V,R<sub>G</sub>=0Ω,Starting T<sub>J</sub>=25°C

3.I<sub>SD</sub>≤68A,di/dt≤300A/us,V<sub>DD</sub><BV<sub>DSS</sub>,STARTING T<sub>J</sub>=25°C

4.Pulse Test:Pulse Width≤300us,Duty Cycle≤2%

5. Essentially independent of operating temperature.

This transistor is an electrostatic sensitive device

Please handle with caution

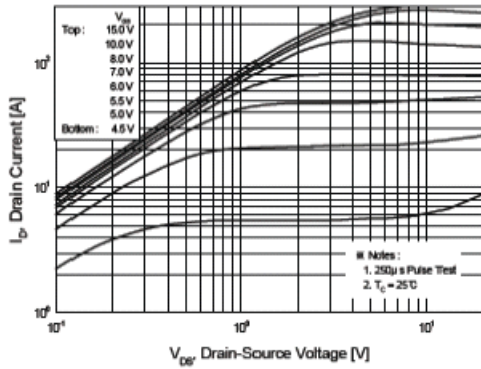

**Fig.1 On State Characteristics**

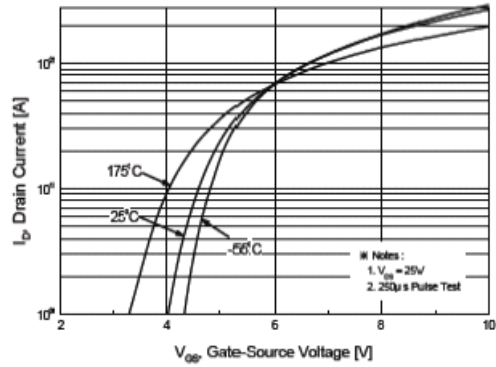

**Fig.2 Transfer Characteristics**

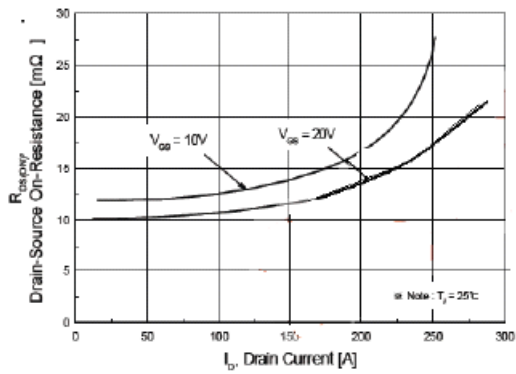

**Fig.3 On Resistance Variation Vs Drain Current and Gate Voltage**

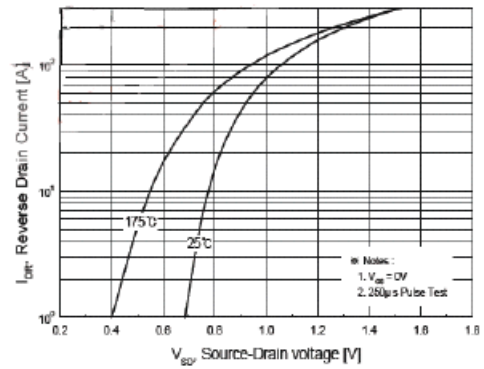

**Fig.4 On State Current vs Allowable case Temperature**

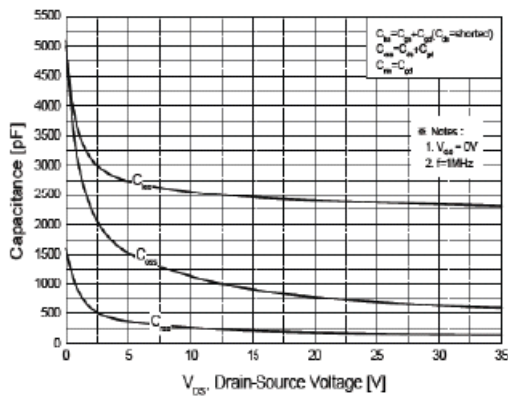

**Fig.5 Capacitance Characteristics**

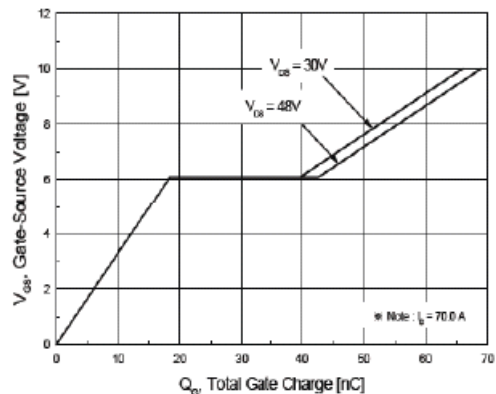

**Fig.6 Gate Charge Characteristics**

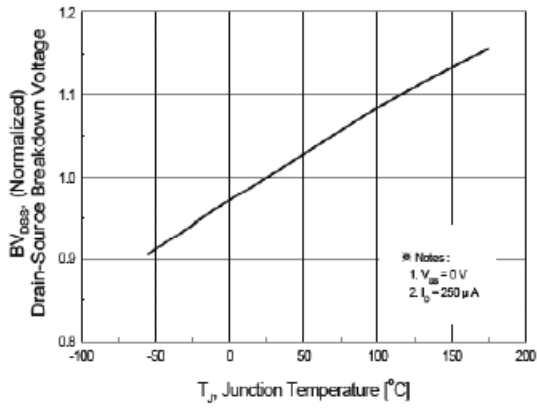

**Fig.7 Breakdown Voltage Variation vs. Junction temperature**

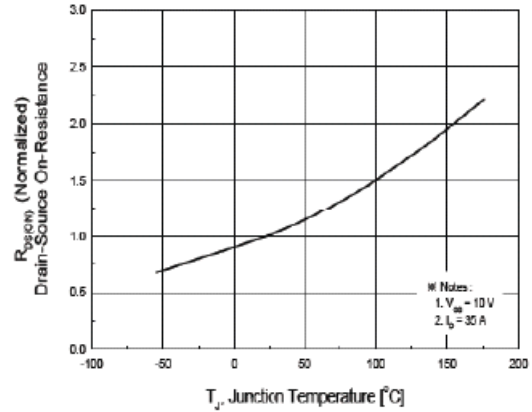

**Fig.8 On-Resistance Variation vs. Junction temperature**

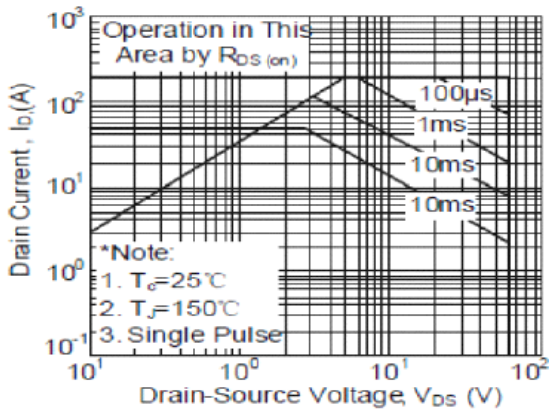

**Fig.9 Maximum Safe Operation Area**

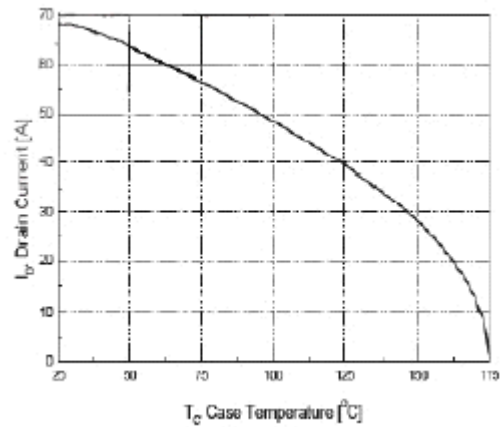

**Fig.10 Maximum Drain Current vs Case temperature**

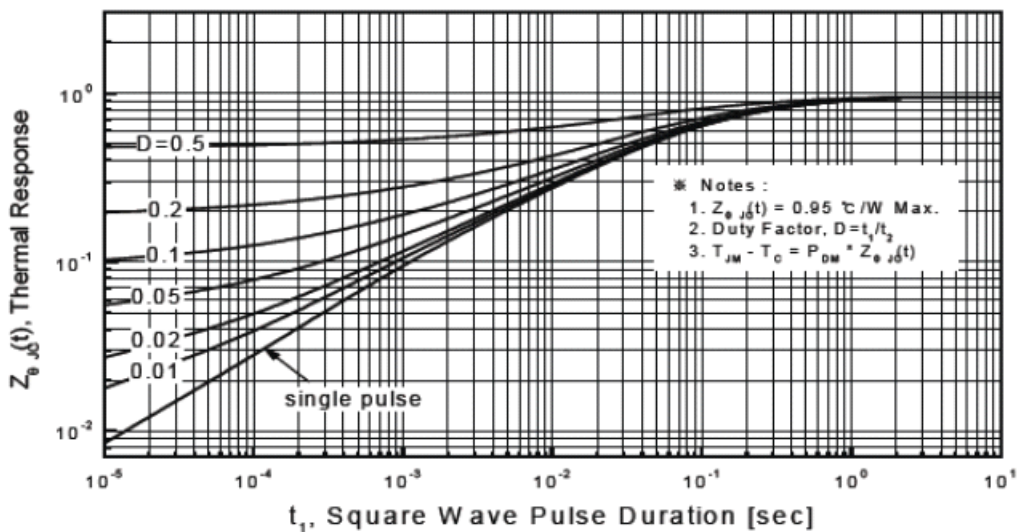

**Fig.11 Transient thermal Response Curve**

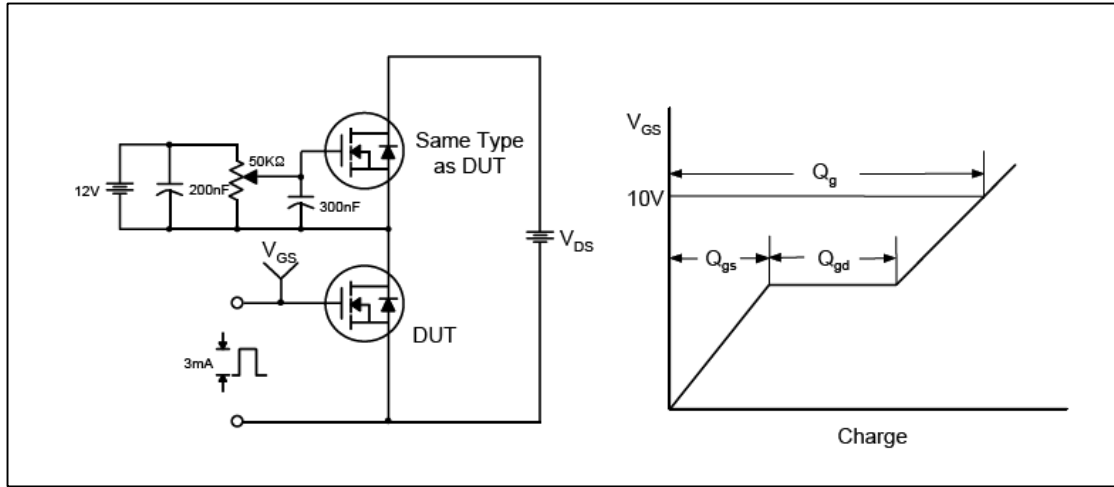

**Fig.12 Gate Test circuit & Waveform**

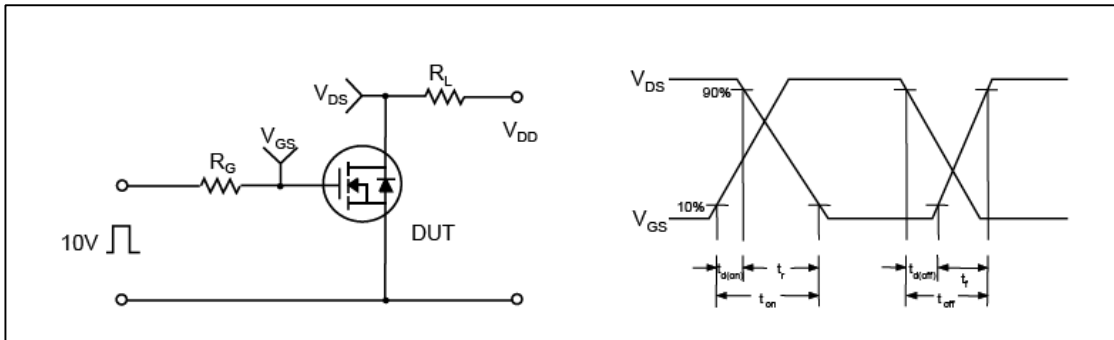

**Fig.13 Resistive Switching Test Circuit & Waveform**

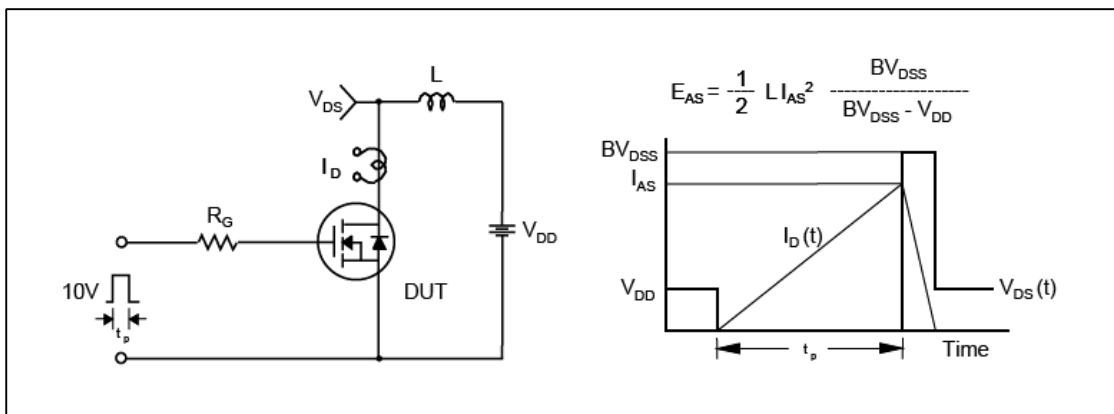

**Fig.14 Unclamped Inductive Switching Test Circuit & Waveform**

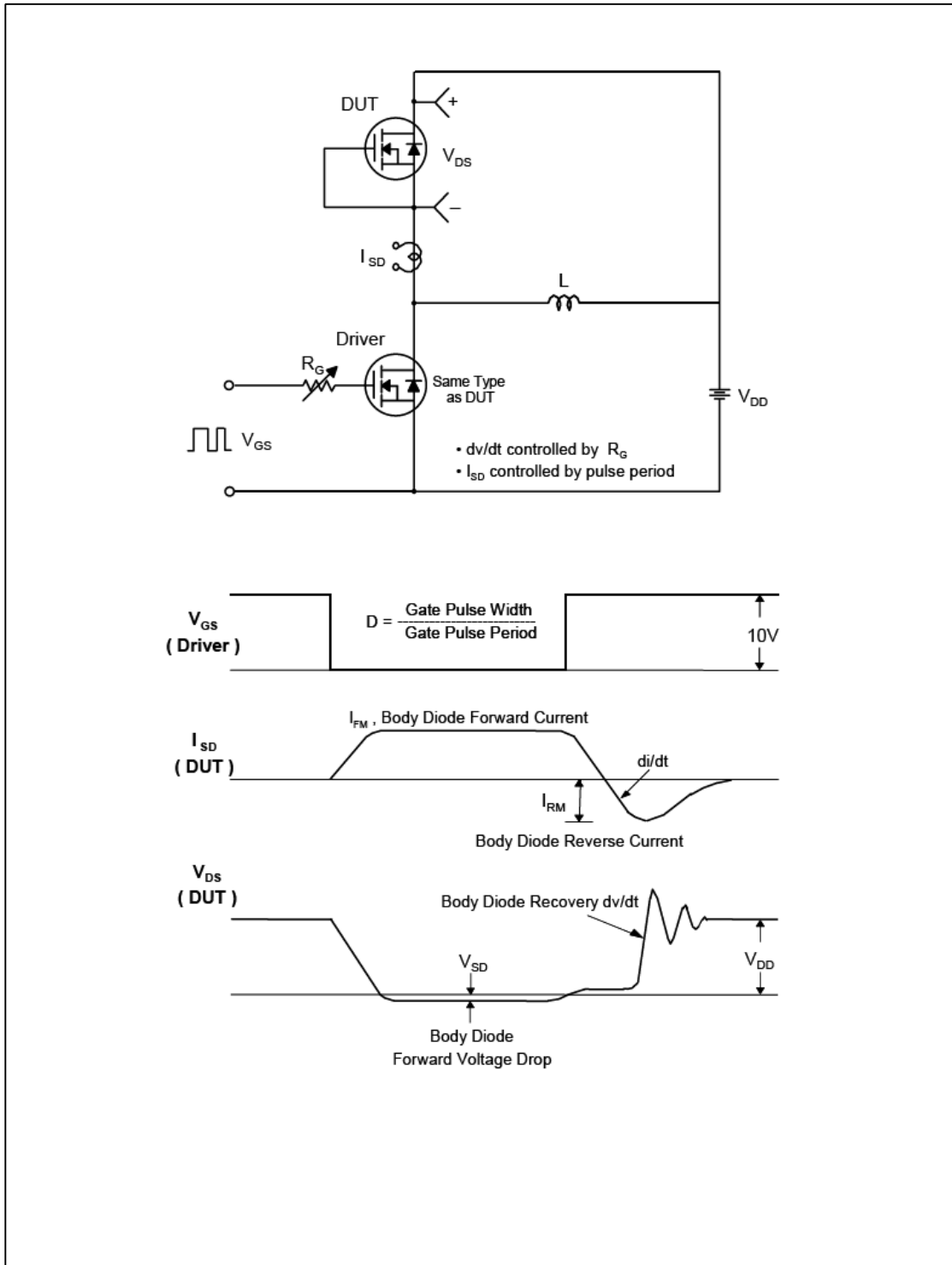

**Fig.15 Peak Diode Recovery  $dv/dt$  Test Circuit & Waveform**

**TO-220 Package Dimension**

