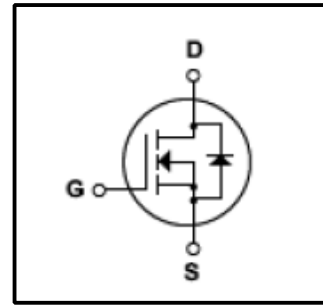
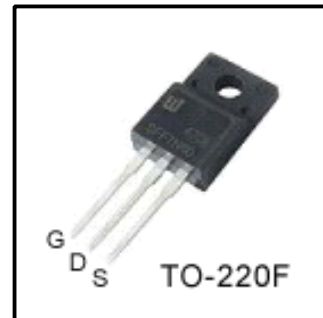

Silicon N-Channel MOSFET
Features

- 2A,600V, $R_{DS(on)}$ (Max 5.0 Ω)@ $V_{GS}=10V$
- Ultra-low Gate Charge(Typical 9nC)
- Fast Switching Capability
- 100%Avalanche Tested
- Maximum Junction Temperature Range(150 $^{\circ}C$)

General Description

This Power MOSFET is produced using Winsemi's advanced planar stripe,VDMOS technology. This latest technology has been especially designed to minimize on -state resistance,have a high rugged avalanche characteristics. This devices is specially well suited for high efficiency switch mode power supply .

Absolute Maximum Ratings

Symbol	Parameter	Value	Units
V_{DSS}	Drain Source Voltage	600	V
I_D	Continuous Drain Current(@ $T_c=25^{\circ}C$)	2.0*	A
	Continuous Drain Current(@ $T_c=100^{\circ}C$)	1.5*	A
I_{DM}	Drain Current Pulsed (Note1)	9.5*	A
V_{GS}	Gate to Source Voltage	± 30	V
E_{AS}	Single Pulsed Avalanche Energy (Note2)	140	mJ
E_{AR}	Repetitive Avalanche Energy (Note1)	2.8	mJ
dv/dt	Peak Diode Recovery dv /dt (Note3)	4.5	V/ ns
P_D	Total Power Dissipation(@ $T_c=25^{\circ}C$)	20	W
	Derating Factor above 25 $^{\circ}C$	0.15	W/ $^{\circ}C$
T_J, T_{stg}	Junction and Storage Temperature	-55~150	$^{\circ}C$
T_L	Channel Temperature	300	$^{\circ}C$

*Drain current limited by maximum junction temperature

Thermal Characteristics

Symbol	Parameter	Value			Units
		Min	Typ	Max	
R_{QJC}	Thermal Resistance , Junction -to -Case	-	-	6.25	$^{\circ}C/W$
R_{QJA}	Thermal Resistance , Junction-to -Ambient	-	-	62.5	$^{\circ}C/W$

Electrical Characteristics(Tc=25°C)

Characteristics		Symbol	Test Condition	Min	Type	Max	Unit
Gate leakage current		I _{GSS}	V _{GS} =±30V,V _{DS} =0V	-	-	±100	nA
Gate-source breakdown voltage		V _{(BR)GSS}	I _G =±10 μA,V _{DS} =0V	±30	-	-	V
Drain cut -off current		I _{DSS}	V _{DS} =600V,V _{GS} =0V	-	-	10	μA
			V _{DS} =480V,Tc=125°C	-	-	100	μA
Drain -source breakdown voltage		V _{(BR)DSS}	I _D =250 μA,V _{GS} =0V	600	-	-	V
Gate threshold voltage		V _{GS(th)}	V _{DS} =10V,I _D =250 μA	2	-	4	V
Drain -source ON resistance		R _{DS(ON)}	V _{GS} =10V,I _D =1A	-	4.5	5.0	Ω
Forward Transconductance		g _{fs}	V _{DS} =50V,I _D =1A	-	2.25	-	S
Input capacitance		C _{iss}	V _{DS} =25V,	-	280	330	pF
Reverse transfer capacitance		C _{rss}	V _{GS} =0V,	-	6	8	
Output capacitance		C _{oss}	f=1MHz	-	45	55	
Switching time	Rise time	t _r	V _{DD} =300V,	-	10	28	ns
	Turn-on time	t _{on}	I _D =2A,	-	25	55	
	Fall time	t _f	R _G =25Ω,	-	20	60	
	Turn-off time	t _{off}	(Note4,5)	-	25	60	
Total gate charge(gate-source plus gate-drain)		Q _g	V _{DD} =320V, V _{GS} =10V,	-	9.0	12	nC
Gate-source charge		Q _{gs}	I _D =2A	-	1.7	-	
Gate-drain("miller") Charge		Q _{gd}	(Note4,5)	-	4.5	-	

Source-Drain Ratings and Characteristics(Ta=25°C)

Characteristics	Symbol	Test Condition	Min	Type	Max	Unit
Continuous drain reverse current	I _{DR}	-	-	-	2.0	A
Pulse drain reverse current	I _{DRP}	-	-	-	8.0	A
Forward voltage(diode)	V _{DSF}	I _{DR} =2.0A,V _{GS} =0V	-	-	1.4	V
Reverse recovery time	t _{rr}	I _{DR} =2A,V _{GS} =0V,	-	180	-	ns
Reverse recovery charge	Q _{rr}	dI _{DR} / dt =100 A / μs	-	0.72	-	μC

Note 1.Repeativity rating :pulse width limited by junction temperature

2.L=18.5mH I_{AS}=2A,V_{DD}=50V,R_G=0Ω ,Starting T_J=25°C

3.I_{SD}≤2A,di/dt≤200A/us,V_{DD}<BV_{DSS},STARTING T_J=25°C

4.Pulse Test:Pulse Width≤300us,Duty Cycle≤2%

5. Essentially independent of operating temperature.

This transistor is an electrostatic sensitive device

Please handle with caution

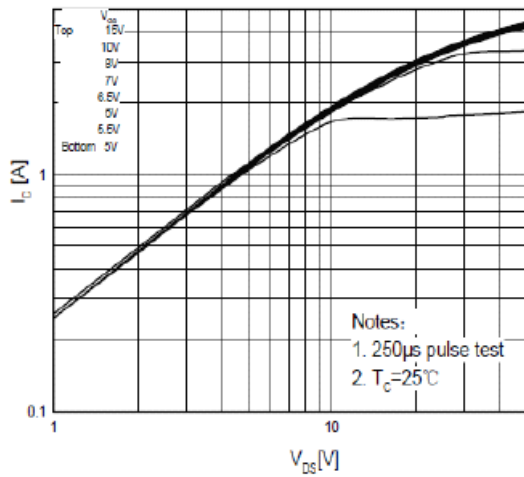

Fig.1 On-State Characteristics

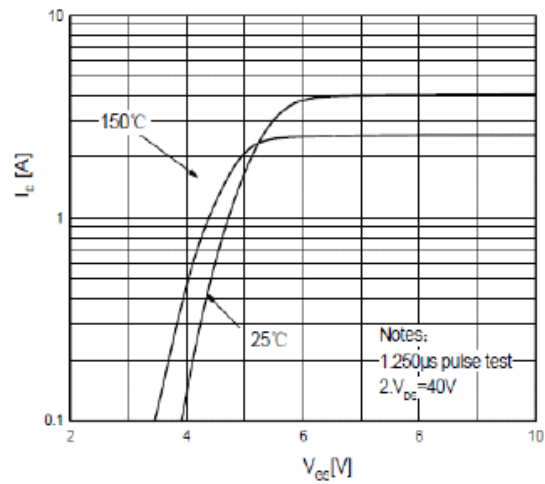

Fig.2 Transfer Current characteristics

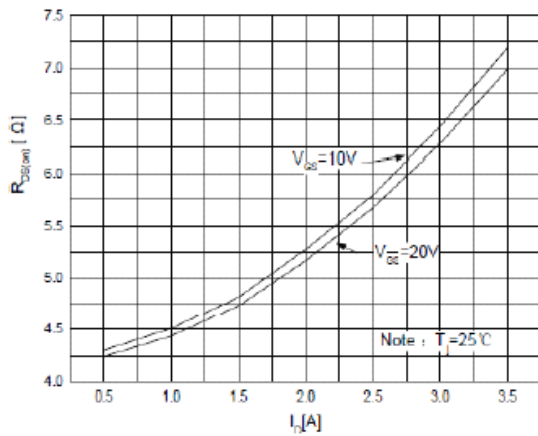

Fig.3 On Resistance variation vs Drain Current

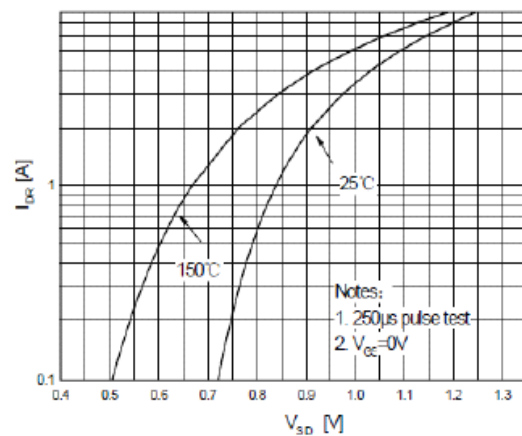

Fig.4 Body Diode Forward Voltage Variation With Source Current And temperature

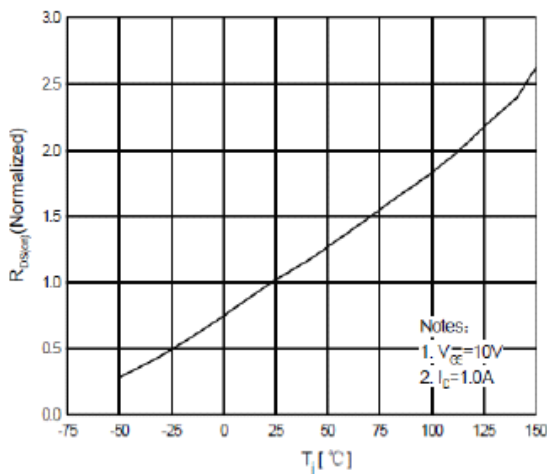

Fig.5 On-Resistance Variation vs Junction Temperature

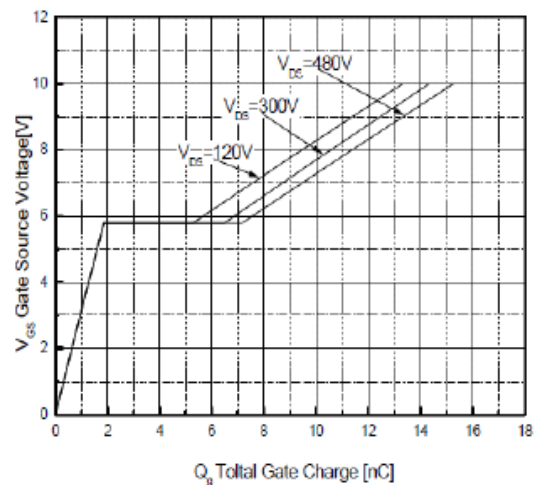

Fig.6 Gate Charge Characteristics

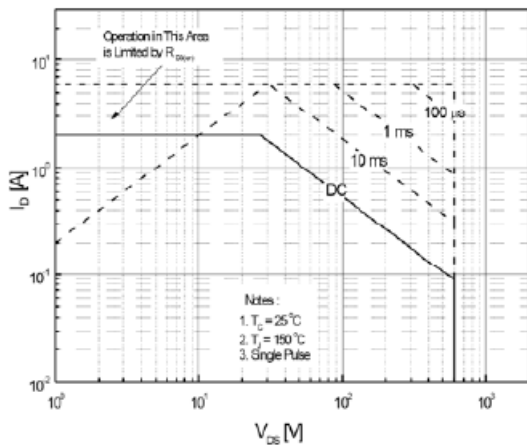

Fig.7 Maximum Safe Operation Area

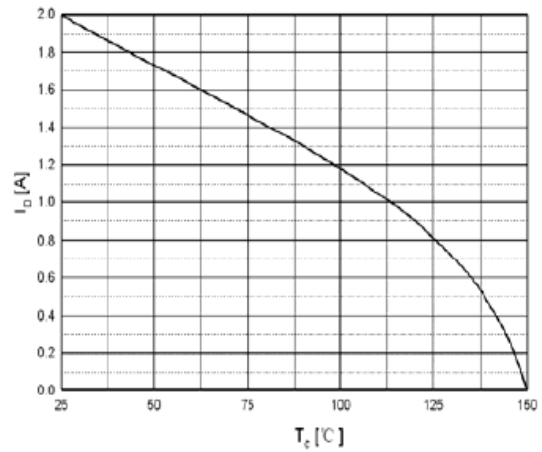

Fig.8 Maximum Drain Current vs Case Temperature

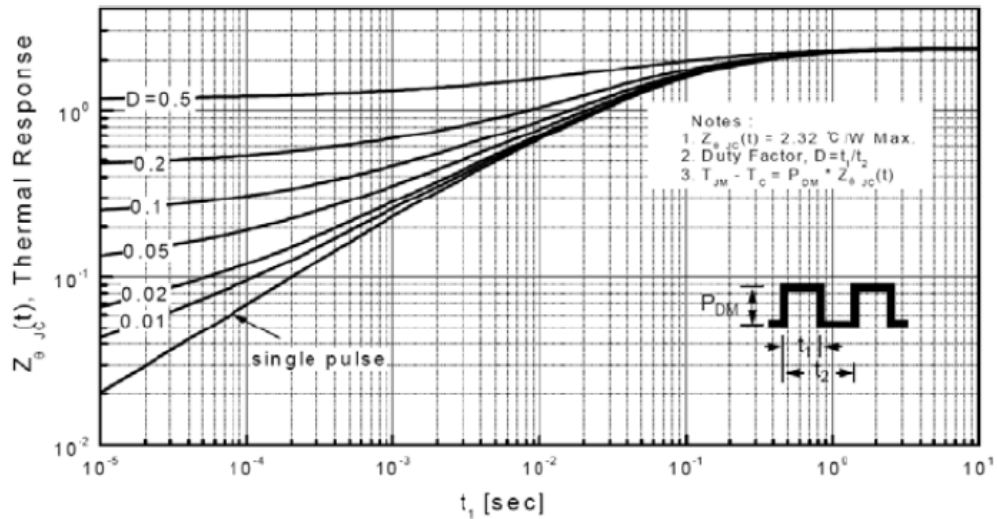

Fig.9 Transient Thermal Response curve

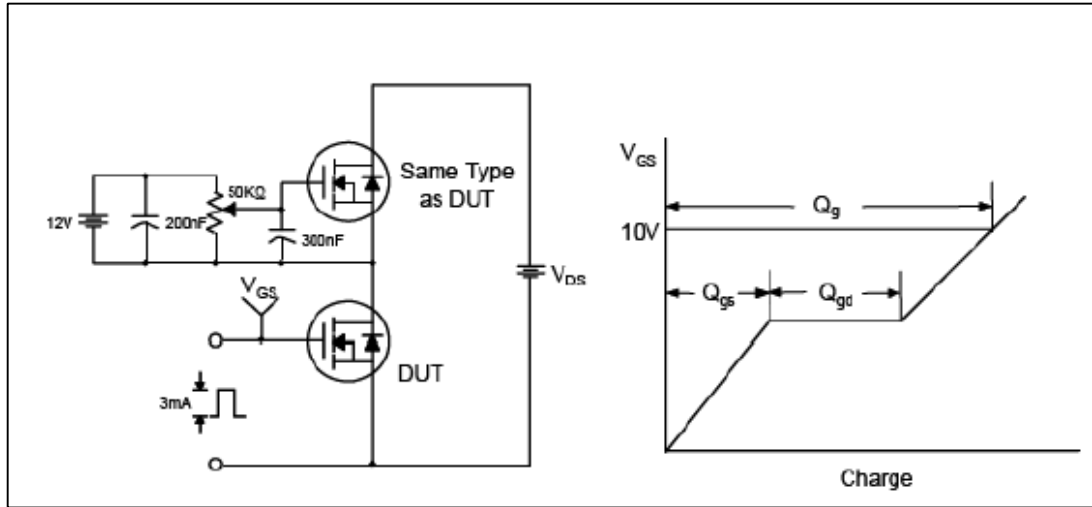

Fig.10 Gate Test circuit & Waveform

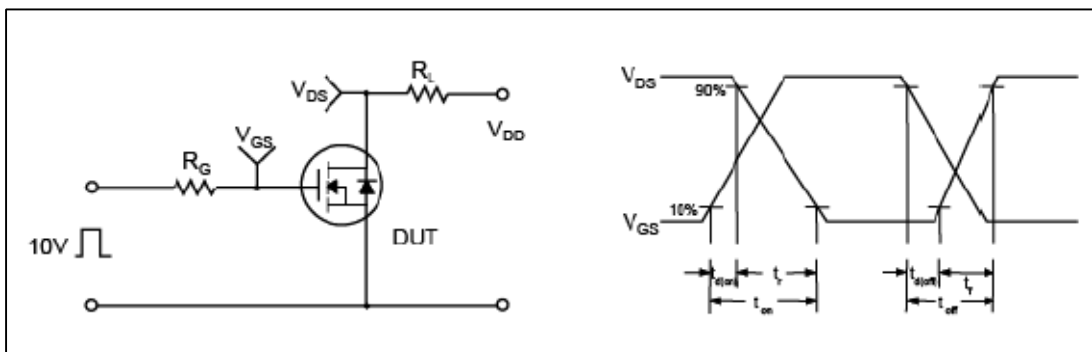

Fig.11 Resistive Switching Test Circuit & Waveform

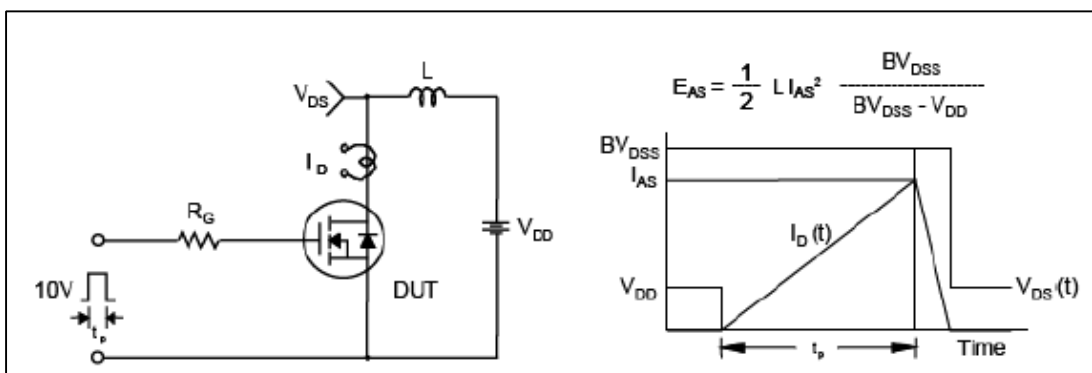

Fig.12 Uncamped Inductive Switching Test Circuit & Waveform

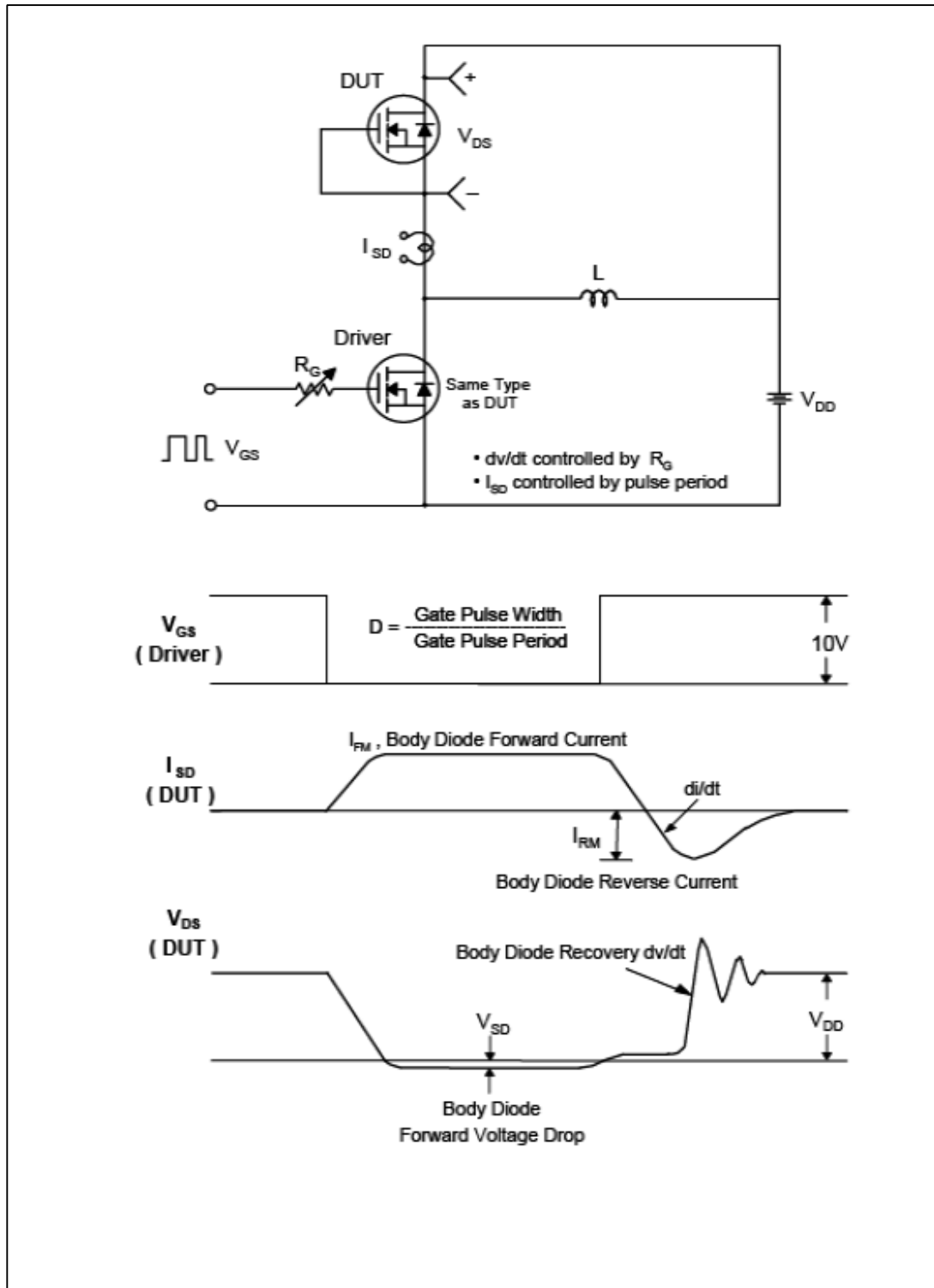

Fig.13 Peak Diode Recovery dv/dt Test Circuit & Waveform

TO220F Package Dimension

