

## ULTRA LOW CAPACITANCE STEERING DIODE ARRAY

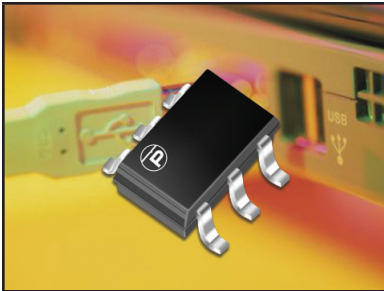

**SOT-23-6 PACKAGE**

### DESCRIPTION

The USB208 is an ultra low capacitance steering diode array. This device provides circuit protection for computer interfaces, wireless bus applications and portable electronics. The USB208 is ideally suited to protect USB data I/O ports against the effects of ESD and EFT.

The USB208 meets the requirements of IEC 61000-4-2 (ESD) and IEC 61000-4-4 (EFT). At higher operating frequencies or faster edge rates, insertion loss and signal integrity are a major concern. The USB208 offers a ultra low capacitance and low leakage current in a SOT-23-6 package.

### FEATURES

- Compatible with IEC 61000-4-2 (ESD): Air - 15kV, Contact - 8kV
- Compatible with IEC 61000-4-4 (EFT): 40A - 5/50ns
- ESD Protection > 25 kilovolts
- 500 Milliwatt Continuous Power Dissipation
- Provides 4 Lines of Protection
- Low Leakage Current < 1.0 $\mu$ A
- Ultra Low Capacitance: 5pF per Diode
- RoHS Compliant
- REACH Compliant

### APPLICATIONS

- USB Interface Ports
- SMART Phones
- Portable Electronics
- Video Interface Ports
- Sensor Ports

### MECHANICAL CHARACTERISTICS

- Molded JEDEC SOT-23-6 Package
- Approximate Weight: 16 milligrams
- Lead-Free Pure-Tin Plating (Annealed)
- Solder Reflow Temperature:  
Pure-Tin - Sn, 100: 260-270°C
- 8mm Tape and Reel Per EIA Standard 481
- Flammability Rating UL 94V-0

### PIN CONFIGURATION

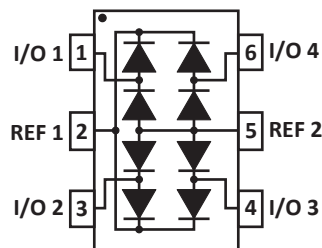

**TYPICAL DEVICE CHARACTERISTICS**
**MAXIMUM RATINGS @ 25°C Unless Otherwise Specified**

PARAMETER	SYMBOL	VALUE	UNITS
Operating Temperature	$T_A$	-55 to 150	°C
Storage Temperature	$T_{STG}$	-55 to 150	°C
Continuous Power Dissipation	$P_{PC}$	500	mW
Repetitive Peak Forward Current @ $t_p = 5\mu s$ , $F = 50kHz$ (Pin 2-3)	$I_{FRM}$	700	mA

**ELECTRICAL CHARACTERISTICS PER LINE @ 25°C Unless Otherwise Specified**

PART NUMBER	DEVICE MARKING	REPETITIVE PEAK REVERSE VOLTAGE  @ 10 $\mu A$ $V_{RRM}$ VOLTS	MAXIMUM REVERSE LEAKAGE CURRENT PER DIODE  @ $V_{RRM}$ @ 5V $I_R$ $\mu A$	TYPICAL FORWARD VOLTAGE  @ 50mA $V_F$ VOLTS	MAXIMUM CAPACITANCE (Note 1)  $C_J$ pF
USB208	PSB	20	1	1.2	5

**NOTES**

1. Apply a 5V bias between pin 2 (REF 1) to pin 5 (REF 2). Measure  $C_J$  between I/O pins to pin 5 (REF 2) and divide by two.

## TYPICAL DEVICE CHARACTERISTICS

FIGURE 1  
PEAK FORWARD CURRENT VS FORWARD VOLTAGE

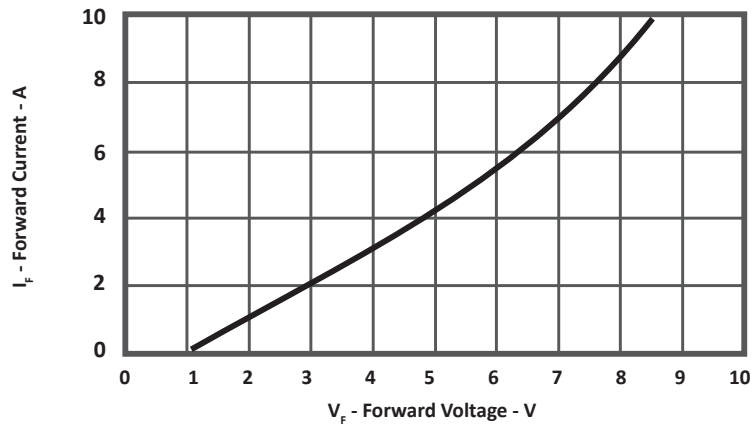
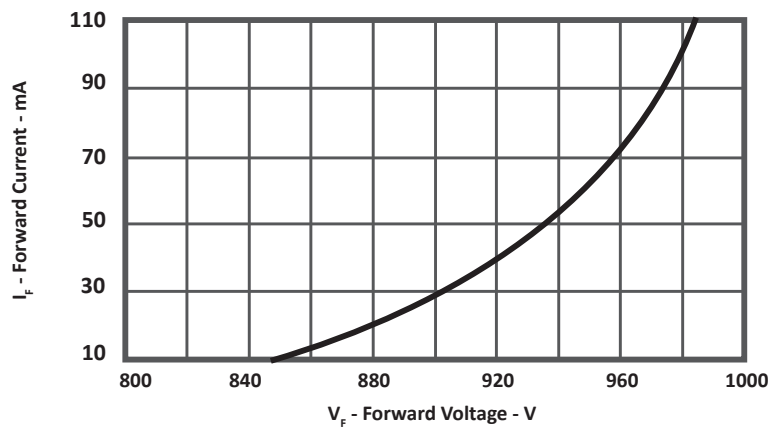
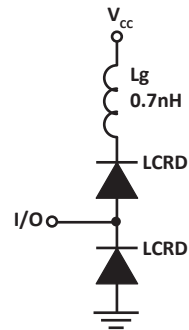

FIGURE 2  
LOW FORWARD CURRENT VS FORWARD VOLTAGE



## SPICE MODEL

**FIGURE 1**  
**SPICE MODEL**



LCRD - Low Capacitance Rectifier Diode  
 Lg - Lead Inductance

**TABLE 1 - SPICE PARAMETERS**

PARAMETER	UNIT	LCRD
BV	V	200
IBV	$\mu\text{A}$	0.01
$C_{jo}$	pF	5
$I_s$	A	1E-13
Vj	V	0.6
M	-	0.33
N	-	1
$R_s$	Ohms	0.31
TT	s	1E-8
EG	eV	1.11

## SOT-23-6 PACKAGE INFORMATION

## OUTLINE DIMENSIONS

DIM	MILLIMETERS		INCHES	
	MIN	MAX	MIN	MAX
A	2.80	3.05	0.110	0.120
B	1.50	1.75	0.059	0.070
C	0.90	1.30	0.036	0.051
D	0.30	0.40	0.012	0.016
E	0.85	1.05	0.033	0.040
G	0.90	1.45	0.036	0.057
J	0.09	0.20	0.003	0.008
K	2.60	3.00	0.102	0.118
L	0.0	0.15	0.0	0.006
M	0.30	0.60	0.012	0.024

## NOTES

- Controlling dimension: inches.
- Dimensioning and tolerances per ANSI Y14.5M, 1985.
- Dimensions are exclusive of mold flash and metal burrs.

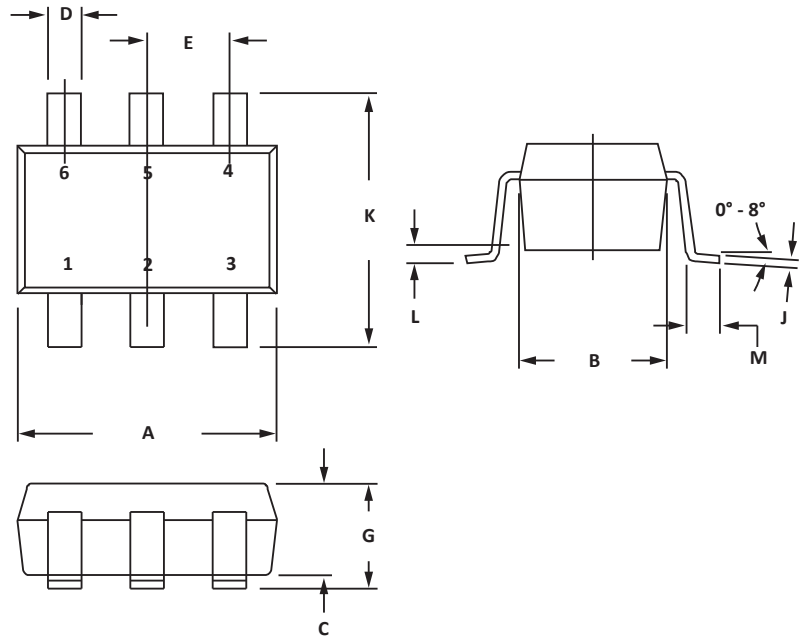

## PAD LAYOUT DIMENSIONS

DIM	MILLIMETERS	INCHES
	NOMINAL	NOMINAL
A	0.70	0.028
B	1.90	0.074
C	0.95	0.037
D	2.40	0.094
E	1.00	0.039

## NOTES

- Controlling dimension: inches.

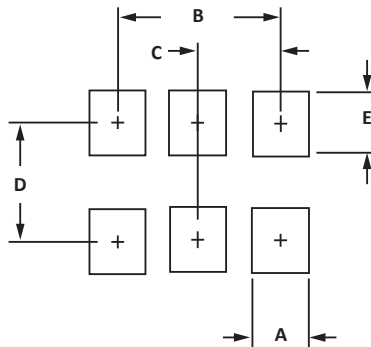

## TAPE AND REEL

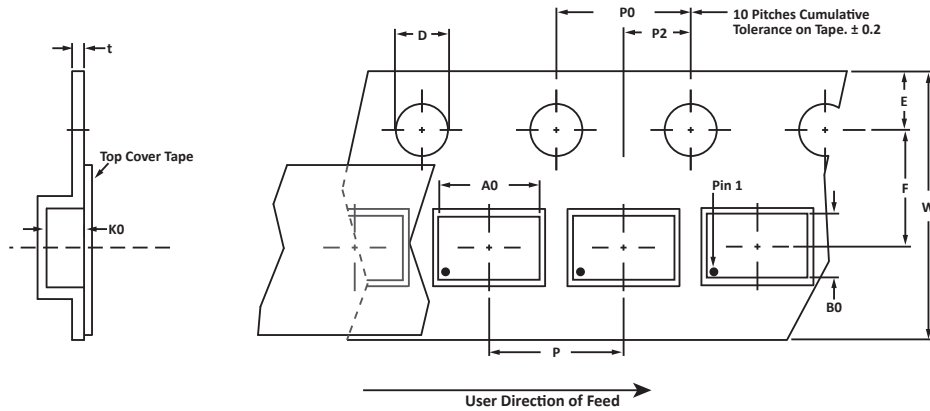

## SPECIFICATIONS

REEL DIA.	TAPE WIDTH	A0	B0	K0	D	E	F	W	P0	P2	P	tmax
178mm (7")	8mm	3.20 ± 0.10	3.20 ± 0.10	1.65 ± 0.10	1.50 ± 0.10	1.75 ± 0.10	3.50 ± 0.05	8.00 ± 0.30	4.00 ± 0.10	2.00 ± 0.05	4.00 ± 0.10	0.25

## NOTES

1. Dimensions are in millimeters.
2. Surface mount product is taped and reeled in accordance with EIA-481.
3. Suffix - T7 = 7" Reel - 3,000 pieces per 8mm tape.
4. Marking on Part - marking code (see page 2) and pin one defined by dot on package.

Package outline, pad layout and tape specifications per document number 06013.R5 2/11

## ORDERING INFORMATION

BASE PART NUMBER	LEADFREE SUFFIX	TAPE SUFFIX	QTY/REEL	REEL SIZE	TUBE QTY
USB208	-LF	-T7	3,000	7"	n/a

## COMPANY INFORMATION

---

### COMPANY PROFILE

ProTek Devices, based in Tempe, Arizona USA, is a manufacturer of Transient Voltage Suppression (TVS) products designed specifically for the protection of electronic systems from the effects of lightning, Electrostatic Discharge (ESD), Nuclear Electromagnetic Pulse (NEMP), inductive switching and EMI/RFI. With over 25 years of engineering and manufacturing experience, ProTek designs TVS devices that provide application specific protection solutions for all electronic equipment/systems.

ProTek Devices Analog Products Division, also manufactures analog interface, control, RF and power management products.

### CONTACT US

#### Corporate Headquarters

2929 South Fair Lane  
Tempe, Arizona 85282  
USA

#### By Telephone

General: 602-431-8101  
Sales: 602-414-5109  
Customer Service: 602-414-5114

#### By Fax

General: 602-431-2288

#### By E-mail:

Sales: [sales@protekdevices.com](mailto:sales@protekdevices.com)  
Customer Service: [service@protekdevices.com](mailto:service@protekdevices.com)  
Technical Support: [support@protekdevices.com](mailto:support@protekdevices.com)

#### Web

[www.protekdevices.com](http://www.protekdevices.com)  
[www.protekanalog.com](http://www.protekanalog.com)

COPYRIGHT © ProTek Devices 2007 - This literature is subject to all applicable copyright laws and is not for resale in any manner.

SPECIFICATIONS: ProTek reserves the right to change the electrical and or mechanical characteristics described herein without notice.

DESIGN CHANGES: ProTek reserves the right to discontinue product lines without notice and that the final judgement concerning selection and specifications is the buyer's and that in furnishing engineering and technical assistance. ProTek assumes no responsibility with respect to the selection or specifications of such products. ProTek makes no warranty, representation or guarantee regarding the suitability of its products for any particular purpose, nor does ProTek assume any liability arising out of the application or use of any product or circuit and specifically disclaims any and all liability without limitation special, consequential or incidental damages.

LIFE SUPPORT POLICY: ProTek Devices products are not authorized for use in life support systems without written consent from the factory.