

## IEC Appliance Inlet C14 with Fuseholder 1- or 2-pole and Voltage Selector

Standard or Medical Fuse drawer



V-Lock

C14  
  
 70° C

**Description**

- Panel Mount:  
Screw-on version from front or rear side, snap-in version from front side
- 3 Functions:  
Appliance Inlet Protection class I, Fuseholder with interchangeable fuse drawer for Fuse-links 5 x 20 mm or 6.3 x 32 mm 1- or 2-pole, Voltage Selectors (series-parallel)
- Quick connect terminals 4.8 x 0.8 mm

**Approvals**

- VDE Certificate Number: 40011908
- UL File Number: E93617
- CSA File Number: 38456

**Characteristics**

- Available with or without internal partial wired connections
- For added safety "Extra-Safe" fuse drawers are available  
Fuse drawer meets requirements of medical standard IEC/EN 60601-1  
The fuse drawer can only be opened with the aid of a tool  
The fuseholder is accessible from the equipment front
- Qualified for use in equipment according IEC/EN 60950

**Other versions on request**

- For protection class II

**References**

Alternative: version with line filter [CE](#)

**Weblinks**

[pdf](#), [General Product Information](#), [Approvals](#), [RoHS](#), [CHINA-RoHS](#), [Mating Connectors](#), [e-Store](#), [SCHURTER-Stock-Check](#), [Distributor-Stock-Check](#), [Accessories](#)

Newly available variants corresponding to V-Lock mating cordset. The connector is equipped with a notch intended for use with the latching cordset. The cord latching system prevents against accidental removal of the cordset.

**Technical Data**

Ratings IEC	10A / 250VAC; 50Hz	Appliance Inlet	C14 acc. to IEC/EN 60320-1, UL 498, CSA C22.2 no. 42 (for cold conditions) pin-temperature 70 °C, 10A, Protection Class 1
Ratings UL/CSA	10A / 125VAC; 60Hz	Fuseholder	1 or 2 pole, Shocksafe category PC2 acc. to IEC 60127-6, for fuse-links 5 x 20 or 6.3 x 32mm
Dielectric Strength	> 3 kVAC between L-N > 4 kVAC between L/N-PE (1 min/50Hz)	Rated Power Acceptance @ Ta 23 °C	5 x 20: 2.5W (1 pole)/ 2W (2-pole) per pole 6.3 x 32: 3.15W (1 pole)/ 2.5W (2-pole) per pole
Allowable Operation Temp.	-25 °C to 70 °C	Power Acceptance @ Ta > 23°C	Admissible power acceptance at higher ambient temperature see derating curves
Degree of Protection	from front side IP 40 acc. to IEC 60529	Voltage Selectors	series-parallel, 4, 3 or 2 switch positions or usable as 2-pole change-over switch
Protection Class	Suitable for appliances with protection class 1 acc. to IEC 61140		
Terminal	Quick connect terminals 4.8 x 0.8 mm		
Panel Thickness s	Screw: max 8 mm Mounting screw torque max 0.5Nm Snap-in: 1.5/2/2.5 mm		
Material: Housing	Thermoplastic, black, UL 94V-0		

**Dimensions**

Screw on PCB mounting

Snap-in mounting

69.5 mm

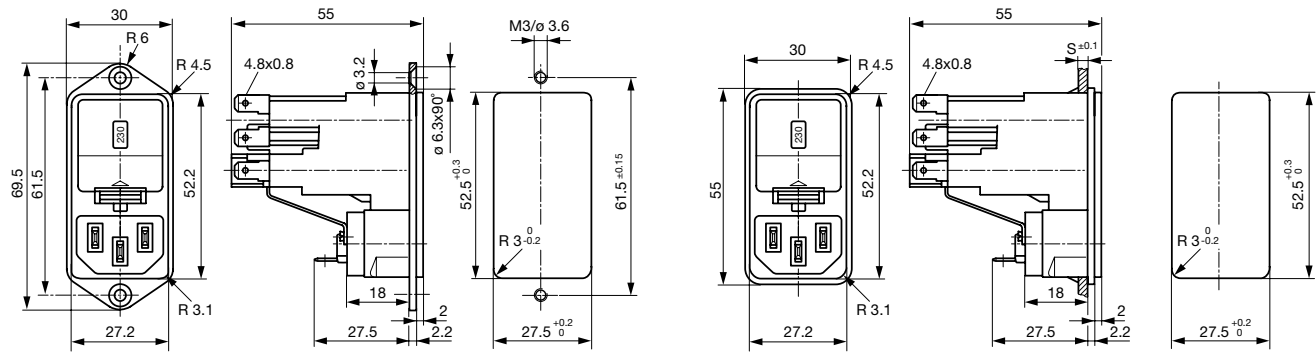

**Diagrams**

with partial wired internal connections

with partial wired

without internal connections

without internal connections

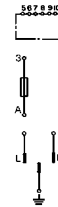
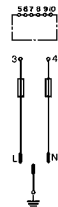
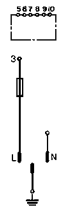

1-pole

2-pole

1-pole

2-pole

**Derating Curves**

Fuses

5 x 20 mm (1-pole)

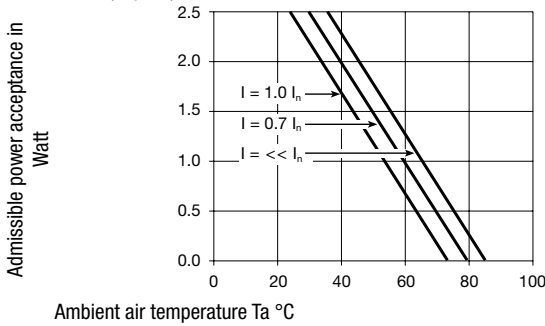

Fuses

5 x 20 mm (2-pole, per pole)

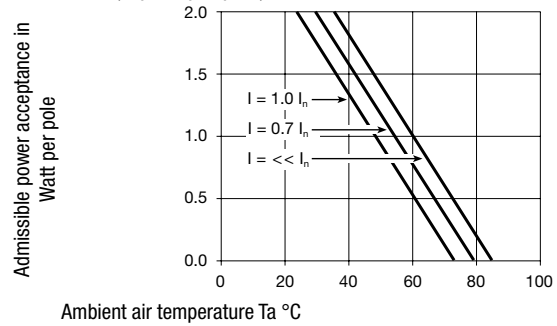

Fuses

6.3 x 32 mm (1-pole)

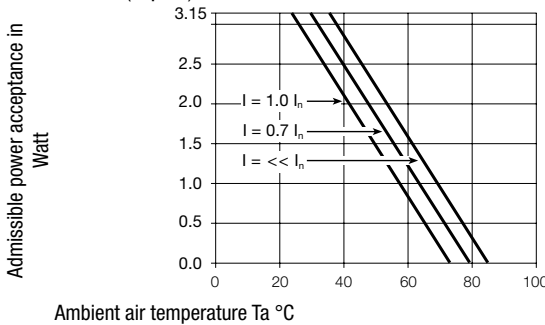

Fuses

6.3 x 32 mm (2-pole, per pole)

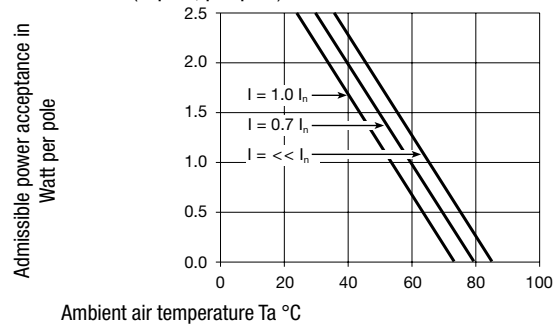

## Variants

Fuseholder and voltage selector insert must be ordered separately

Panel mounting	Panel Thickness s [mm]	Fuseholder	Internally wired	Order Number
Screw	-	1-pole	unwired	KE15.1100.151
Screw	-	1-pole	partially wired	KE16.5100.151
Screw	-	2-pole	unwired	KE10.2100.151
Screw	-	2-pole	partially wired	KE10.6100.151
Snap-in	1.5	1-pole	unwired	KE15.1100.105
Snap-in	2	1-pole	unwired	KE15.1100.107
Snap-in	2.5	1-pole	unwired	KE15.1100.109
Snap-in	1.5	1-pole	partially wired	KE16.5100.105
Snap-in	2	1-pole	partially wired	KE16.5100.107
Snap-in	2.5	1-pole	partially wired	KE16.5100.109
Snap-in	1.5	2-pole	unwired	KE10.2100.105
Snap-in	2	2-pole	unwired	KE10.2100.107
Snap-in	2.5	2-pole	unwired	KE10.2100.109
Snap-in	1.5	2-pole	partially wired	KE10.6100.105
Snap-in	2	2-pole	partially wired	KE10.6100.107
Snap-in	2.5	2-pole	partially wired	KE10.6100.109

**Packaging unit** 20 Pcs

## Required Accessory

### Description



**Jumper Wire 1**  
Connection with Stranded Cable

Type A, 70	0881.0074
Type A, 100	0881.0075
Type B, 70	0881.0076
Type B, 100	0881.0077



**Fusedrawer 1**  
Fusedrawer for Fuse Links 5x20mm resp.. 6.3x32mm

5 x 20, 2-pole	4305.0001
5 x 20, 1-pole	4305.0006
6.3 x 32, 2-pole	4305.0011
6.3 x 32, 1-pole	4305.0016

...



**Voltage Selectors Insert 1**  
Voltage Selector Insert to KE, CE, KG, CG

3 or 4 switch positions	4305.0048.00
1, 3 or 4 switch positions, 100, 120, 220, 240	4305.0048.01
3, 3 or 4 switch positions, 130, 110, 240, 220	4305.0048.02
2, 2 switch positions, 110, 220	4305.0048.03

...

Accessories

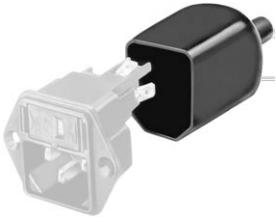

Assorted Covers  
Rear Cover

	0859.0076
--	-----------



Cord retaining kits  
Cord retaining strain relief

Flat head, A	4700.0001
--------------	-----------

Mating Outlets/Connectors

Category / Description

Appliance Outlet Overview complete



IEC Appliance Outlet F, Screw-on Mounting, Front Side, Solder Terminal	4787
IEC Appliance Outlet F, Snap-in Mounting, Front Side, Solder or Quick-connect Terminal	4788
IEC Appliance Outlet F or H, Screw-on Mounting, Front Side, Solder, PCB or Quick-connect Terminal	5091
IEC Appliance Outlet F or H, Screw-on Mounting, Front Side, Solder or Quick-connect Terminal	5092

Appliance Outlet further types to KE

Connector Overview complete



IEC Connector C15, Rewireable, Straight	0101
IEC Connector C15A, Rewireable, Straight	0102
IEC Connector C15A, Rewireable, Straight	0102-G
IEC Connector C15A, Rewireable, Angled	0112
IEC Connector C13, Rewireable, Angled	4012

Connector further types to KE

...

Power Cord Overview complete



Power Cord with IEC Connector C13, Angled	0311
Power Cord with IEC Connector C13, Angled	3011
Power Cord with IEC Connector C13, Angled	3012
Power Cord with IEC Connector C13, Angled	3013
Power Cord with IEC Connector C13	3020

Power Cord further types to KE

...