

3mm

# LED CBI® Circuit Board Indicator .120" High LED Centerline

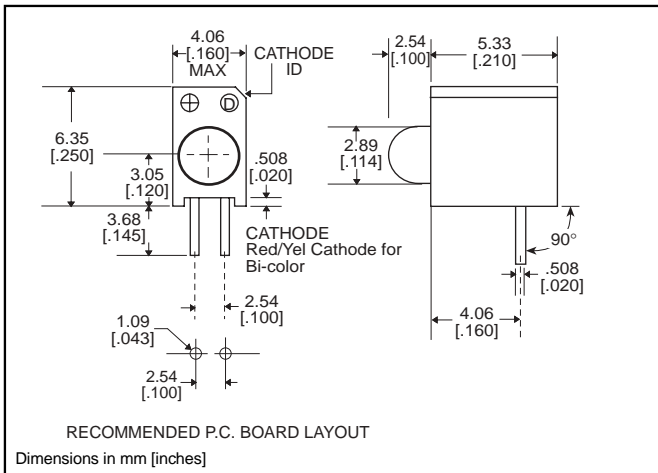

## 551-xx09



### Features

- Multiple CBIs form horizontal LED arrays on 4.2mm (0.165") center-lines
- High Contrast, UL 94 V-0 rated, black housing
- Oxygen index: 31.5%
- Polymer content: PBT, 0.128 g
- Housing stand-offs facilitate PCB cleaning
- Solderability per MIL-STD-202F, method 208F
- LEDs are safe for direct viewing per IEC 825-1, EN-60825-1

### Tolerance note: As noted, otherwise:

- LED Protrusion:  $\pm 0.04$  mm [ $\pm 0.016$ ]
- CBI Housing:  $\pm 0.02$ mm [ $\pm 0.008$ ]

### PART NO.

#### HIGH EFFICIENCY

- 551-0209
- 551-0309
- 551-0409
- 551-0809
- 551-2509

### COLOR

- Green
- Yellow
- Red
- Blue<sup>3</sup>
- Orange



#### INTEGRAL RESISTOR, 5 VOLTS

- 551-0509
- 551-0609
- 551-0709

- Red
- Green
- Yellow

#### LOW CURRENT

- 551-1109
- 551-1209
- 551-1309

- Red
- Yellow
- Green

#### BI-COLOR

- 551-3009
- 551-3109

- Red/Green
- Yellow/Green



3



**ATTENTION**  
OBSERVE PRECAUTIONS  
FOR HANDLING  
ELECTROSTATIC  
SENSITIVE  
DEVICES

# 551-xx09

## Typical Operating Characteristics ( $T_A=25^{\circ}\text{C}$ )

See LED data sheet for additional information  
See page 4-70 and 4-71 for Reference Only LED Drive Circuit Examples. See page 4-72 for Pin Out

### HIGH EFFICIENCY

Part Number	Color	Peak Wavelength nm	I <sub>v</sub> mcd	V <sub>F</sub> Volts	Test Current (mA)	Viewing Angle 2 $\theta_{\%}$	LED Data sheet	Page #
551-0209	Green	563	16	2.1	10	45°	521-9408	4-64
551-0309	Yellow	585	6.3	2.1	10	45°	521-9428	4-64
551-0409	Red	650	10	2	10	45°	521-9427	4-64
551-0809	Blue	428	12	3.5	10	70°	521-9831	4-57
551-2509	Orange	600	7	2.2	10	60°	521-9498	4-58

### INTEGRAL RESISTOR, 5 VOLTS

Part Number	Color	Peak Wavelength nm	I <sub>v</sub> mcd	Test Voltage	Forward Current (mA)	Viewing Angle 2 $\theta_{\%}$	LED Data sheet	Page #
551-0509	Red	635	29	5	10	60°	521-9215	4-59
551-0609	Green	565	19	5	10	60°	521-9323	4-59
551-0709	Yellow	585	12.6	5	10	60°	521-9322	4-59

### LOW CURRENT

Part Number	Color	Peak Wavelength nm	I <sub>v</sub> mcd	V <sub>F</sub> Volts	Test Current (mA)	Viewing Angle 2 $\theta_{\%}$	LED Data sheet	Page #
551-1109	Red	635	1.6	1.7	2	60°	521-9324	4-60
551-1209	Yellow	585	1.6	1.8	2	60°	521-9325	4-60
551-1309	Green	565	1.6	1.9	2	60°	521-9326	4-60

### BI-COLOR

Part Number	Color	Peak Wavelength nm	I <sub>v</sub> mcd	V <sub>F</sub> Volts	Test Current (mA)	Viewing Angle 2 $\theta_{\%}$	LED Data sheet	Page #
551-3009	Red/Green	635/565	4.7/10	2	10	50°	521-9459	4-63
551-3109	Yellow/Green	585/565	4.3/6.3	2.1*/2.1*	10	80°	521-9478	4-62

\* I<sub>F</sub> = 20mA





**3mm Discrete LED  
Tinted, Diffused**



**521-9831**

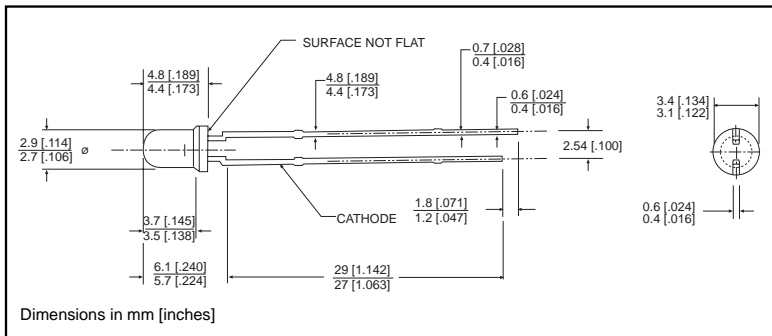

**PART NO.**  
521-9831

**COLOR**  
Blue<sup>3</sup>

**MOUNTING CLIP:** 515-0006  
located on page 4-65



<b>ABSOLUTE MAXIMUM RATINGS</b> ( $T_A=25^\circ\text{C}$ )		Blue -9831
Power Dissipation (mW)		100
Forward Current (mA)		20
Derating (mA/°C) From 55°C		.44
Operating Temperature (°C)		-40/+100
Storage Temperature (°C)		-40/+100
Soldering Temperature	260°C, 5 seconds, 1.6 mm from case	

Solder Adherence per MIL-STD-202E, Method 208C

<b>OPERATING CHARACTERISTICS</b> ( $T_A=25^\circ\text{C}$ )		Blue -9831
Luminous Intensity (mcd) $I_F=10\text{mA}$	Min.	6.3
	Typical	12
Peak Wavelength (nm) $\lambda_{\text{Peak}}$	Typical	428
Viewing Angle ( $2\theta_{1/2}$ )	Typical	70°
Forward Voltage (V) $I_F=10\text{mA}$	Typical	3.5
	Max.	4.2
Reverse Voltage (V) $I_R=10\mu\text{A}$	Min.	3

$\theta^1$  is the off axis angle at which the luminous intensity is half the axial luminous intensity

**3mm Discrete LED**  
**High Efficiency**  
**Diffused**

**Dialight**

**521-9210, -9211, -9216, -9498, -9636**

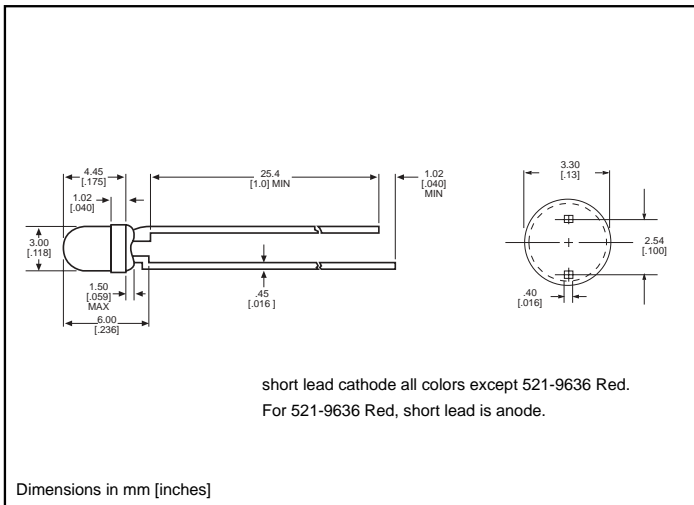

PART NO.	COLOR
521-9210	Green
521-9211	Yellow
521-9216	Red
521-9498	Orange
521-9636	Red



**MOUNTING CLIP: 515-0006**  
 located on page 4-65

<b>ABSOLUTE MAXIMUM RATINGS</b> ( $T_A=25^\circ\text{C}$ )	Green <b>-9210</b>	Yellow <b>-9211</b>	Red <b>-9216</b>	Orange <b>-9498</b>	Red <b>-9636</b>
Power Dissipation (mW)	100	60	100	135	100
Forward Current (mA)	30	20	30	25	40
Derating (mA/°C) From 50°C <sup>1</sup> from 25°C	.4	.25	.4	.5	.5 <sup>1</sup>
Operating Temperature (°C)	-55/+100	-55/+100	-55/+100	-55/+100	-55/+100
Storage Temperature (°C)	-55/+100	-55/+100	-55/+100	-55/+100	-55/+100
Soldering Temperature	260°C, 5 seconds, 1.6 mm from body				

Solder Adherence per MIL-STD-202E, Method 208C

<b>OPERATING CHARACTERISTICS</b> ( $T_A=25^\circ\text{C}$ )		Green <b>-9210</b>	Yellow <b>-9211</b>	Red <b>-9216</b>	Orange <b>-9498</b>	Red <b>-9636</b>
Luminous Intensity (mcd)	Min.	4.7	7.4	7.4	3.4	8.7 <sup>1</sup>
	Typical	12.6	10	10	7	48 <sup>1</sup>
Peak Wavelength (nm)	Typical	565	585	635	600	660
Viewing Angle ( $2\theta$ °)	Typical	60°	60°	60°	60°	60°
Forward Voltage (V)	Typical	2.1 <sup>1</sup>	2.1 <sup>1</sup>	2 <sup>1</sup>	2.2	1.8 <sup>1</sup>
	Max.	2.8 <sup>1</sup>	2.8 <sup>1</sup>	2.8 <sup>1</sup>	3	2.4 <sup>1</sup>
Reverse Voltage (V), $I_R=100\mu\text{A}$	Max.	5	5	5	5	4

<sup>1</sup> is the off axis angle at which the luminous intensity is half the axial luminous intensity

**3mm Discrete LED  
Integral Resistor, 5V  
Diffused**

**Dialight**

**521-9215, -9322, -9323**

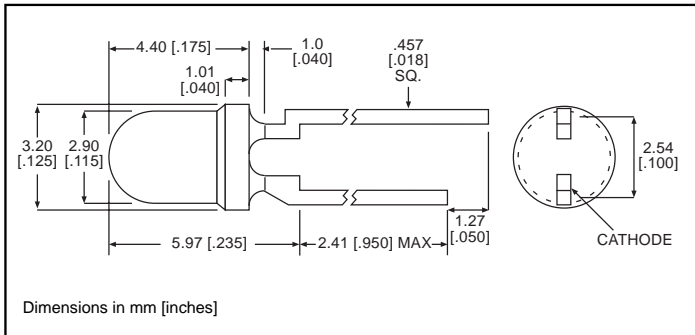

<u>PART NO.</u>	<u>COLOR</u>
521-9215	Red
521-9322	Yellow
521-9323	Green

**MOUNTING CLIP: 515-0006**  
located on page 4-65

**ABSOLUTE MAXIMUM RATINGS** ( $T_A=25^\circ\text{C}$ )

	Red <b>-9215</b>	Yellow <b>-9322</b>	Green <b>-9323</b>
Forward Voltage (V)	7.5	7.5	7.5
Derating (V/ $^\circ\text{C}$ ) From 50 $^\circ\text{C}$	.086	.086	.071
Operating Temperature ( $^\circ\text{C}$ )	-40/+85	-40/+85	-20/+85
Storage Temperature ( $^\circ\text{C}$ )	-55/+100	-55/+100	-55/+100
Soldering Temperature	260 $^\circ\text{C}$ , 5 seconds, 1.6 mm from case		

Solder Adherence per MIL-STD-202E, Method 208C

**OPERATING CHARACTERISTICS** ( $T_A=25^\circ\text{C}$ )

		Red <b>-9215</b>	Yellow <b>-9322</b>	Green <b>-9323</b>
Luminous Intensity (mcd)	Min.	8.7	3.7	5.6
	Typical	29	12.6	19
Peak Wavelength (nm)	Typical	635	585	565
Viewing Angle ( $2\theta_{1/2}$ )	Typical	60 $^\circ$	60 $^\circ$	60 $^\circ$
Forward Current (mA)	Typical	10	10	10
	Max.	20	20	20
Reverse Voltage (V), $I_R=100\mu\text{A}$	Min.	5	5	5

$\theta_{1/2}$  is the off axis angle at which the luminous intensity is half the axial luminous intensity

**4**

**3mm Discrete LED  
Low Current  
Diffused**

**Dialight**

**521-9324, -9325, -9326**

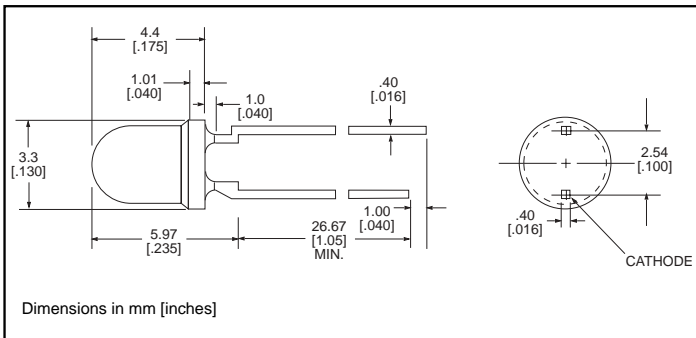

**PART NO.**

**COLOR**

521-9324  
521-9325  
521-9326

Red  
Yellow  
Green

**MOUNTING CLIP: 515-0006**  
located on page 4-65

**ABSOLUTE MAXIMUM RATINGS** ( $T_A=25^\circ\text{C}$ )

	Red <b>-9324</b>	Yellow <b>-9325</b>	Green <b>-9326</b>
Power Dissipation (mW)	20	20	20
Forward Current (mA)	7	7	7
Derating (mA/°C) <i>From 90°C</i>	.7	.7	.7
Peak Current (mA) <i>Pulse width = 10 μs</i>	500	500	500
Operating Temperature (°C)	-55/+100	-55/+100	-55/+100
Storage Temperature (°C)	-55/+100	-55/+100	-55/+100
Soldering Temperature	260°C, 5 seconds, 1.6 mm from case		

*Solder Adherence per MIL-STD-202E, Method 208C*

**OPERATING CHARACTERISTICS** ( $T_A=25^\circ\text{C}$ )

		Red <b>-9324</b>	Yellow <b>-9325</b>	Green <b>-9326</b>
Luminous Intensity (mcd)	Min.	1	1	1
	Typical	1.6	1.6	1.6
Peak Wavelength (nm)	Typical	635	585	565
Viewing Angle ( $2\theta$ °)	Typical	60°	60°	60°
Forward Voltage (V)	Typical	1.7	1.8	1.9
	Max.	2.2	2.7	2.2
Reverse Voltage (V), $I_R=50\mu\text{A}$	Min.	5	5	5

$\theta$  is the off axis angle at which the luminous intensity is half the axial luminous intensity

**3mm Discrete LED  
Bi-Color  
Non-Tinted, Diffused**

**Dialight**

**521-9478, -9628, -9768**

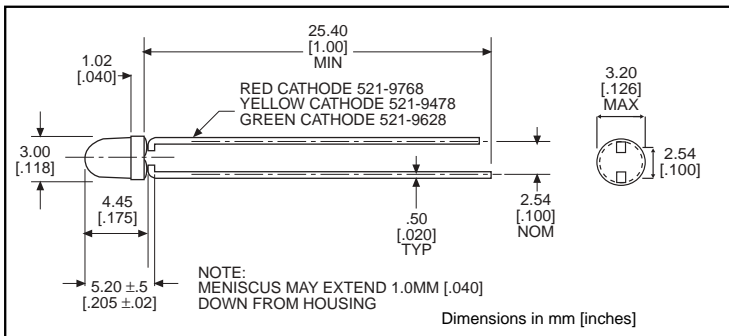

<u>PART NO.</u>	<u>COLOR</u>
521-9478	Yellow/Green
521-9628	Red/Green
521-9768	Red/Yellow

**MOUNTING CLIP: 515-0006**  
located on page 4-65

<b>ABSOLUTE MAXIMUM RATINGS</b> ( $T_A=25^\circ\text{C}$ )	Yellow/Green <b>-9478</b>	Red/Green <b>-9628</b>	Red/Yellow <b>-9768</b>
Power Dissipation (mW)	60/100	140/100	100/60
Forward Current (mA)	20/30	40/30	30/20
Derating (mA/°C) From 25°C From 50°C	.25/.40 <sup>1</sup>	.5/.4	.4/.25 <sup>1</sup>
Peak Current (mA) Pulse width = 10µs	80/120	200/120	120/80
Operating Temperature (°C)	-55/+100	-55/+100	-55/+100
Storage Temperature (°C)	-55/+100	-55/+100	-55/+100
Soldering Temperature	260°C, 5 seconds, 1.66 mm from case		

Solder Adherence per MIL-STD-202E, Method 208C

<b>OPERATING CHARACTERISTICS</b> ( $T_A=25^\circ\text{C}$ )		Yellow/Green <b>-9478</b>	Red/Green <b>-9628</b>	Red/Yellow <b>-9768</b>
Luminous Intensity (mcd)	Min.	2.5/2.5	3.7*/1.1*	1.7*/1.7*
	Typical	4.3/6.3	12.6*/3.7*	5.6*/5.6*
Peak Wavelength (nm)	Typical	585/565	660/565	630/585
$\lambda$ Peak				
Viewing Angle ( $2\theta$ °)	Typical	80°	200°	80°
Forward Voltage (V)	Typical	2.1/2.1	1.8/2.1	2/2.1
	Max.	2.8/2.8	2.4/2.8	2.8/2.8
Reverse Voltage (V) $I_R=100\text{ua}$	Min.	5	5	5

$\theta$  <sup>1</sup> is the off axis angle at which the luminous intensity is half the axial luminous intensity

**3mm Discrete LED  
Bi-Color  
Non-Tinted, Diffused**

**Dialight**

**521-9459**

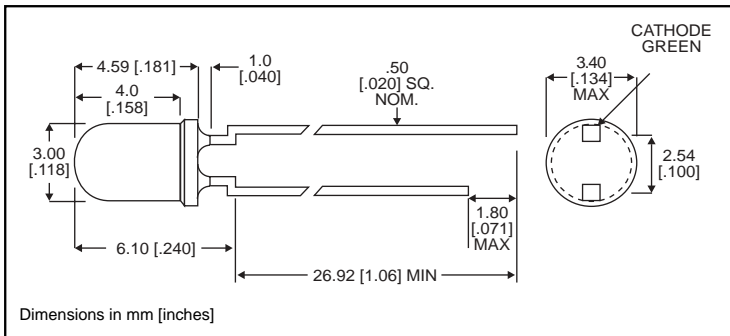

**PART NO.** 521-9459  
**COLOR** Red/Green

**MOUNTING CLIP:** 515-0006  
located on page 4-65

**ABSOLUTE MAXIMUM RATINGS** ( $T_A=25^\circ\text{C}$ )

	Red/Green <b>-9459</b>
Power Dissipation (mW)	140
Forward Current (mA)	45
Derating (mA/°C) From 25°C	.6
Peak Current (mA) <i>Pulse width = 10µs</i>	1000
Operating Temperature (°C)	-55/+100
Storage Temperature (°C)	-55/+100
Soldering Temperature	260°C, 5 seconds, 1.6 mm from case

*Solder Adherence per MIL-STD-202E, Method 208C*

**OPERATING CHARACTERISTICS** ( $T_A=25^\circ\text{C}$ )

		Red/Green <b>-9459</b>
Luminous Intensity (mcd) $I_F=10\text{mA}$	Min. Typical	2.5/3.7 4.7/10
Peak Wavelength (nm) $\lambda_{\text{Peak}}$	Typical	635/565
Viewing Angle ( $2\theta_{1/2}$ )	Typical	50°
Forward Voltage (V) $I_F=10\text{mA}$	Typical Max.	2/2.1 2.8/2.8

$\theta_{1/2}$  is the off axis angle at which the luminous intensity is half the axial luminous intensity



