



# Frontier Electronics Corp.

667 E. COCHRAN STREET, SIMI VALLEY, CA 93065

TEL: (805) 522-9998 FAX: (805) 522-9989

E-mail: [frontiersales@frontierusa.com](mailto:frontiersales@frontierusa.com)

Web: <http://www.frontierusa.com>

## 3A GLASS PASSIVATED ULTRA FAST RECOVERY RECTIFIER

### UF5400G-LFR THRU UF5408G-LFR

#### FEATURES

- PLASTIC PACKAGE HAS UNDERWRITERS LABORATORY FLAMMABILITY CLASSIFICATION 94V-0
- ULTRA FAST RECOVERY TIMES FOR HIGH EFFICIENCY
- LOW FORWARD VOLTAGE, HIGH CURRENT CAPABILITY
- LOW LEAKAGE
- HIGH SURGE CAPABILITY
- HIGH TEMPERATURE SOLDERING GUARANTEED:  
260°C/0.375" (9.5mm) LEAD LENGTHS FOR 10 SECONDS AT 5 LBS. (2.3 KG) TENSION.
- GLASS PASSIVATED JUNCTION
- ROHS

#### MECHANICAL DATA

- CASE: JEDEC DO-201AD, MOLDED PLASTIC, DIMENSIONS IN INCHES AND (MILLIMETERS)
- TERMINALS: AXIAL LEADS SOLDERABLE PER MIL-STD-202, METHOD 208
- POLARITY: COLOR BAND DENOTES CATHODE END
- MOUNTING POSITION: ANY
- WEIGHT: 1.2 GRAM

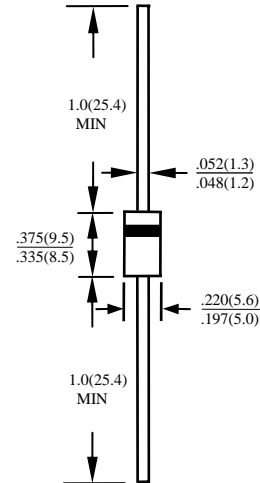

MAXIMUM RATINGS AND ELECTRICAL CHARACTERISTICS RATINGS AT 25°C AMBIENT TEMPERATURE UNLESS OTHERWISE SPECIFIED SINGLE PHASE, HALF WAVE, 60 HZ, RESISTIVE OR INDUCTIVE LOAD. FOR CAPACITIVE LOAD, DERATE CURRENT BY 20%

RATINGS	SYMBOL	UF 5400G -LFR	UF 5401G -LFR	UF 5402G -LFR	UF 5403G -LFR	UF 5404G -LFR	UF 5406G -LFR	UF 5407G -LFR	UF 5408G -LFR	UNITS
MAXIMUM RECURRENT PEAK REVERSE VOLTAGE	$V_{RRM}$	50	100	200	300	400	600	800	1000	V
MAXIMUM RMS VOLTAGE	$V_{RMS}$	35	70	140	210	280	420	560	700	V
MAXIMUM DC BLOCKING VOLTAGE	$V_{DC}$	50	100	200	300	400	600	800	1000	V
MAXIMUM AVERAGE FORWARD RECTIFIED CURRENT 0.375"(9.5mm) LEAD LENGTH AT TA=55°C	$I_O$	3.0								A
PEAK FORWARD SURGE CURRENT, 8.3ms SINGLE HALF SINE-WAVE SUPERIMPOSED ON RATED LOAD	$I_{FSM}$	150								A
TYPICAL JUNCTION CAPACITANCE (NOTE 1)	$C_J$	75				50				PF
TYPICAL THERMAL RESISTANCE (NOTE 2)	$R_{\theta jc}$	20								°C/W
STORAGE TEMPERATURE RANGE	$T_{STG}$	- 55 TO + 150								°C
OPERATING TEMPERATURE RANGE	$T_{OP}$	- 55 TO + 150								°C

#### ELECTRICAL CHARACTERISTICS (A<sub>T</sub> T<sub>A</sub> =25°C UNLESS OTHERWISE NOTED)

CHARACTERISTICS	SYMBOL	UF 5400G -LFR	UF 5401G -LFR	UF 5402G -LFR	UF 5403G -LFR	UF 5404G -LFR	UF 5406G -LFR	UF 5407G -LFR	UF 5408G -LFR	UNITS
MAXIMUM FORWARD VOLTAGE AT I <sub>O</sub> DC	$V_F$	1.3				1.7				V
MAXIMUM DC REVERSE CURRENT AT TA=25°C	$I_R$	10								µA
MAXIMUM DC REVERSE CURRENT AT TA=100°C	$I_R$	10								µA
MAXIMUM REVERSE RECOVERY TIME (NOTE 3)	$T_{RR}$	50							75	nS

- NOTE: 1. MEASURED AT 1 MHZ AND APPLIED REVERSE VOLTAGE OF 4.0 VOLTS  
 2. BOTH LEADS ATTACHED TO HEAT SINK 20x20x1t(mm) COPPER PLATE AT LEAD LENGTH 5mm  
 3. REVERSE RECOVERY TEST CONDITIONS: I<sub>F</sub>=0.5A, I<sub>R</sub>=1.0A, I<sub>RR</sub>=0.25

# RATINGS AND CHARACTERISTIC CURVE UF5400G-LFR THRU UF5408G-LFR

FIG. 1-TEST CIRCUIT DIAGRAM AND REVERSE RECOVERY TIME CHARACTERISTIC

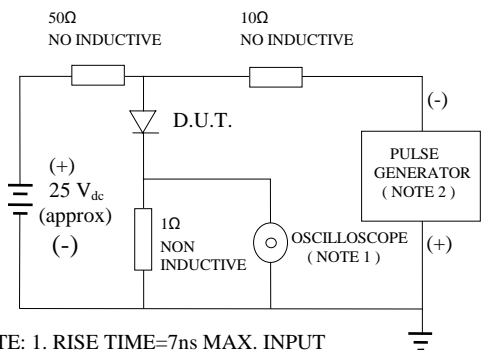

NOTE: 1. RISE TIME=7ns MAX. INPUT IMPEDANCE=1 MOhms 22PF  
 2. RISE TIME =10ns MAX. SOURCE IMPEDANCE=50 OHMS

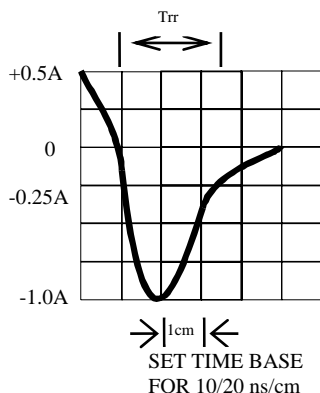

FIG. 2 -TYPICAL FORWARD CURRENT DERATING CURVE

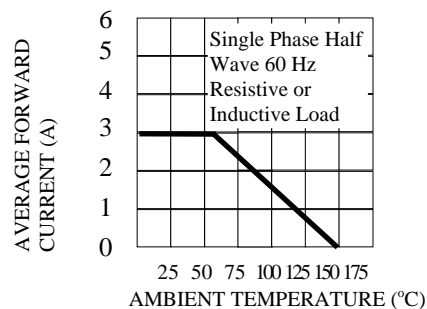

FIG. 3 -TYPICAL REVERSE CHARACTERISTICS

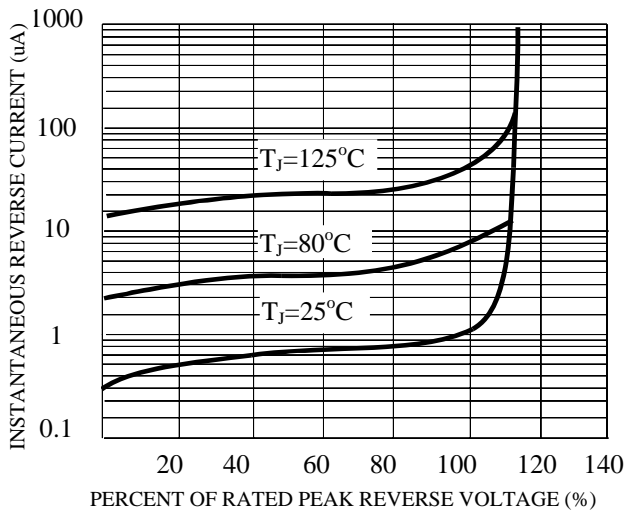

FIG. 4 -TYPICAL INSTANTANEOUS FORWARD CHARACTERISTICS

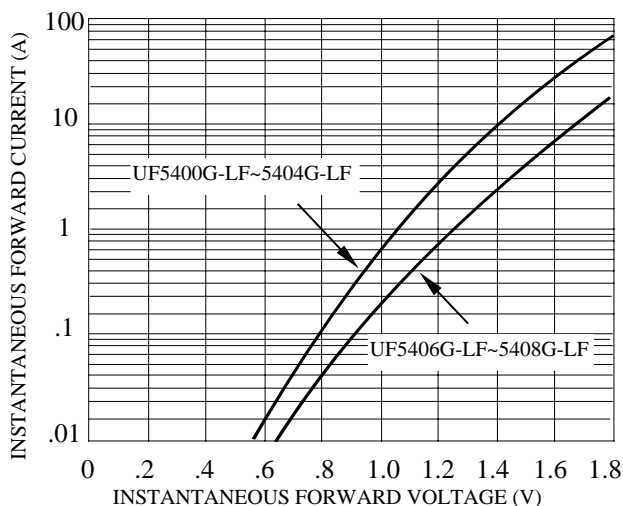

FIG. 5 -MAXIMUM NON-REPETITIVE FORWARD SURGE CURRENT

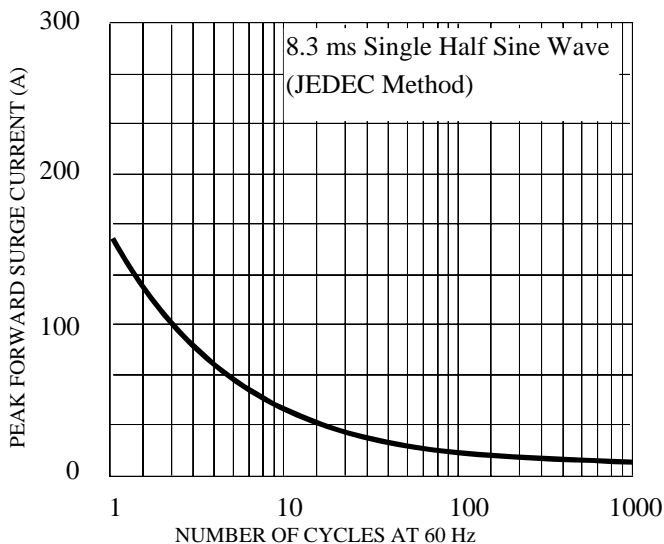

FIG. 6 -TYPICAL JUNCTION CAPACITANCE

