



Thermally-Enhanced High Power RF LDMOS FETs 100 W, 1805 – 1880 MHz

Description

The PTFA181001GL and PTFA181001HL are 100-watt LDMOS FETs designed for EDGE and WCDMA power amplifier applications in the 1805 to 1880 MHz band. Features include input and output matching, and thermally-enhanced open-cavity packages with copper flanges. Manufactured with Infineon's advanced LDMOS process, these devices provide excellent thermal performance and superior reliability.

PTFA181001GL*
Package PG-63248-2

PTFA181001HL*
Package PG-64248-2

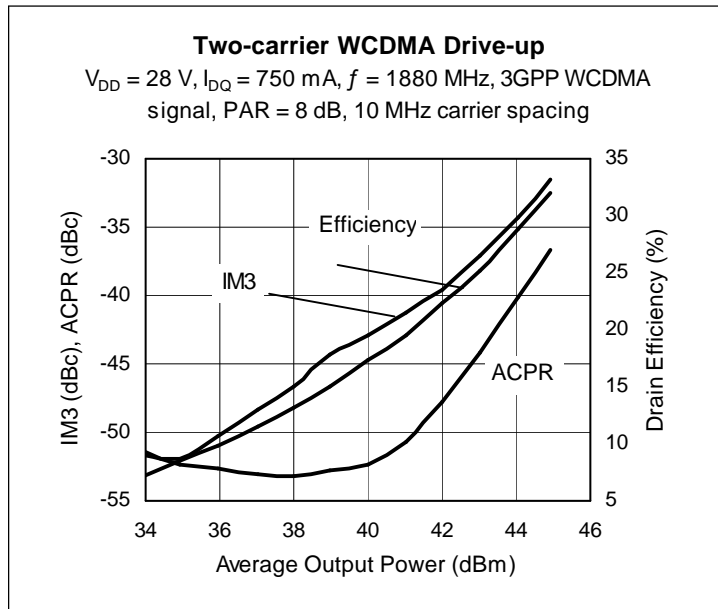
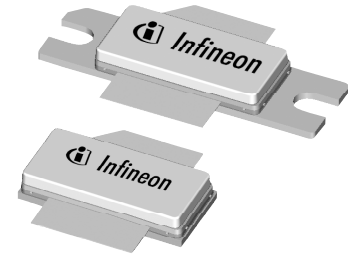

Features

- Thermally-enhanced, plastic open-cavity (EPOC™) packages with copper flanges, Pb-free and RoHS compliant
- Broadband internal matching
- Typical EDGE performance at 1879.8 MHz, 28 V
 - Average output power = 45 W
 - Linear Gain = 16.5 dB
 - Efficiency = 36%
 - EVM RMS = 1.8%
- Typical CW performance, 1880 MHz, 28 V
 - Output power at P-1dB = 120 W
 - Gain 15.5 dB
 - Efficiency = 52%
- Integrated ESD protection: Human Body Model, Class 2 (minimum)
- Excellent thermal stability
- Capable of handling 10:1 VSWR @ 28 V, 100 W (CW) output power

RF Characteristics

EDGE Measurements (not subject to production test—verified by design/characterization in Infineon test fixture)

$V_{DD} = 28\text{ V}$, $I_{DQ} = 750\text{ mA}$, $P_{OUT} = 45\text{ W (AVG)}$, $f = 1879.8\text{ MHz}$

Characteristic	Symbol	Min	Typ	Max	Unit
Error Vector Magnitude	RMS EVM	—	1.8	—	%
Modulation Spectrum @ 400 KHz	ACPR	—	-61	—	dBc
Modulation Spectrum @ 600 KHz	ACPR	—	-73	—	dBc
Gain	G_{ps}	—	16.5	—	dB
Drain Efficiency	η_D	—	36	—	%

All published data at $T_{CASE} = 25^\circ\text{C}$ unless otherwise indicated

*See Infineon distributor for future availability.

ESD: Electrostatic discharge sensitive device—observe handling precautions!

RF Characteristics (cont.)

Two-tone Measurements (tested in Infineon test fixture)

$V_{DD} = 28\text{ V}$, $I_{DQ} = 750\text{ mA}$, $P_{OUT} = 100\text{ W PEP}$, $f = 1850\text{ MHz}$, tone spacing = 1 MHz

Characteristic	Symbol	Min	Typ	Max	Unit
Gain	G_{ps}	—	16.5	—	dB
Drain Efficiency	η_D	—	41	—	%
Intermodulation Distortion	IMD	—	-30	—	dBc

DC Characteristics

Characteristic	Conditions	Symbol	Min	Typ	Max	Unit
Drain-Source Breakdown Voltage	$V_{GS} = 0\text{ V}$, $I_{DS} = 10\text{ mA}$	$V_{(BR)DSS}$	65	—	—	V
Drain Leakage Current	$V_{DS} = 28\text{ V}$, $V_{GS} = 0\text{ V}$	I_{DSS}	—	—	1.0	μA
	$V_{DS} = 63\text{ V}$, $V_{GS} = 0\text{ V}$	I_{DSS}	—	—	10.0	μA
On-State Resistance	$V_{GS} = 10\text{ V}$, $V_{DS} = 0.1\text{ V}$	$R_{DS(on)}$	—	0.085	—	Ω
Operating Gate Voltage	$V_{DS} = 28\text{ V}$, $I_D = 750\text{ mA}$	V_{GS}	2.0	2.5	3.0	V
Gate Leakage Current	$V_{GS} = 10\text{ V}$, $V_{DS} = 0\text{ V}$	I_{GSS}	—	—	1.0	μA

Maximum Ratings

Parameter	Symbol	Value	Unit
Drain-Source Voltage	V_{DSS}	65	V
Gate-Source Voltage	V_{GS}	-0.5 to +12	V
Junction Temperature	T_J	200	$^{\circ}\text{C}$
Total Device Dissipation Above 25 $^{\circ}\text{C}$ derate by	P_D	TBD	W
		TBD	W/ $^{\circ}\text{C}$
Storage Temperature Range	T_{STG}	-40 to +150	$^{\circ}\text{C}$
Thermal Resistance ($T_{CASE} = 70^{\circ}\text{C}$, 100 W CW)	$R_{\theta JC}$	TBD	$^{\circ}\text{C/W}$

Ordering Information

Type and Version	Package Type	Package Description	Shipping	Marking
PTFA181001GL* V1	PG-63248-2	Thermally-enhanced, plastic open-cavity, slotted flange, single-ended	Tray	PTFA181001GL
PTFA181001HL* V1	PG-64248-2	Thermally-enhanced, plastic open-cavity, earless flange, single-ended	Tray	PTFA181001HL

*See Infineon distributor for future availability.

Typical Performance (data taken in a production test fixture)

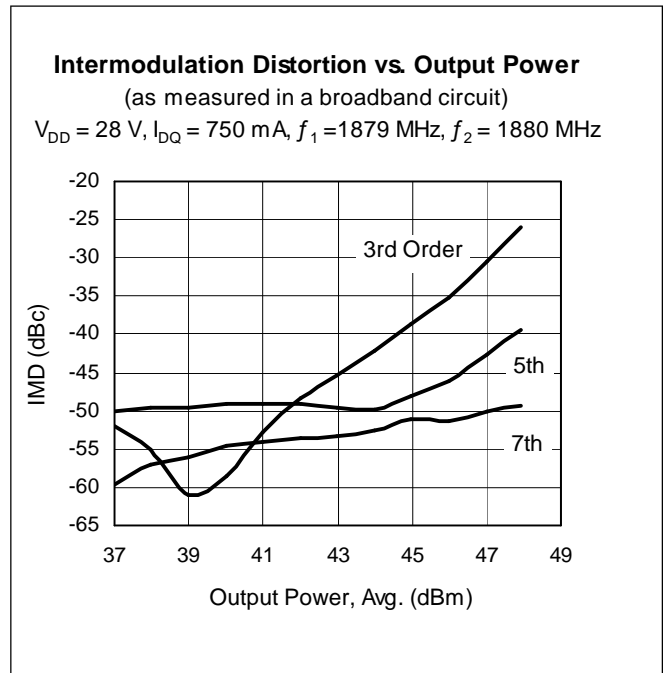
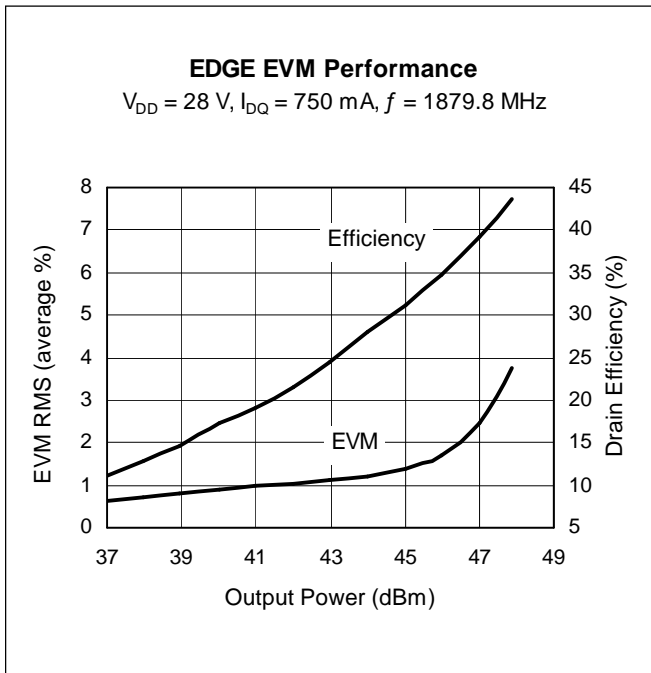
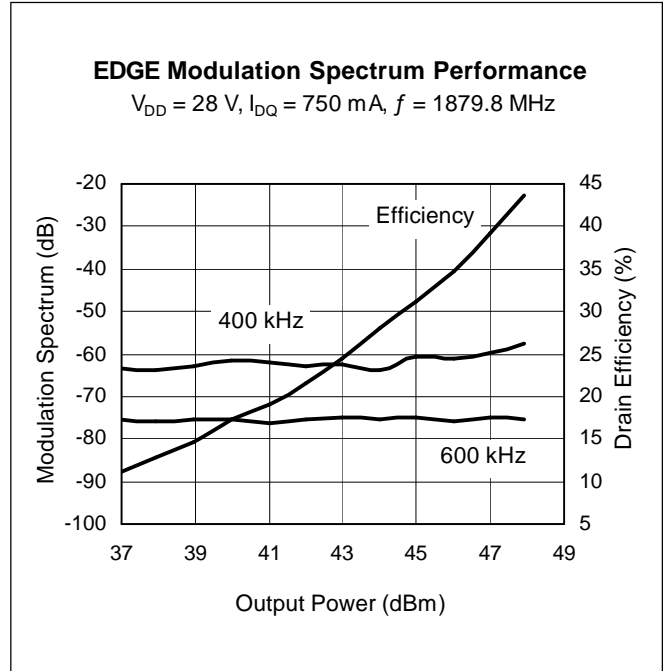
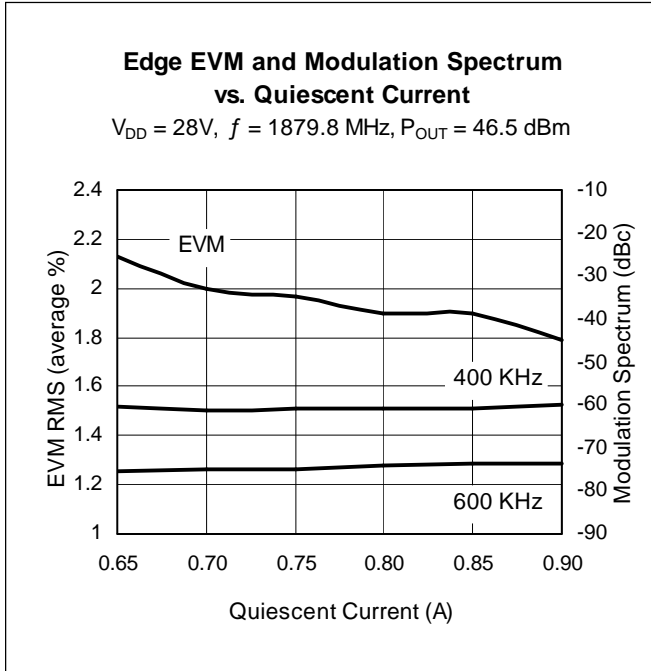

Typical Performance (cont.)

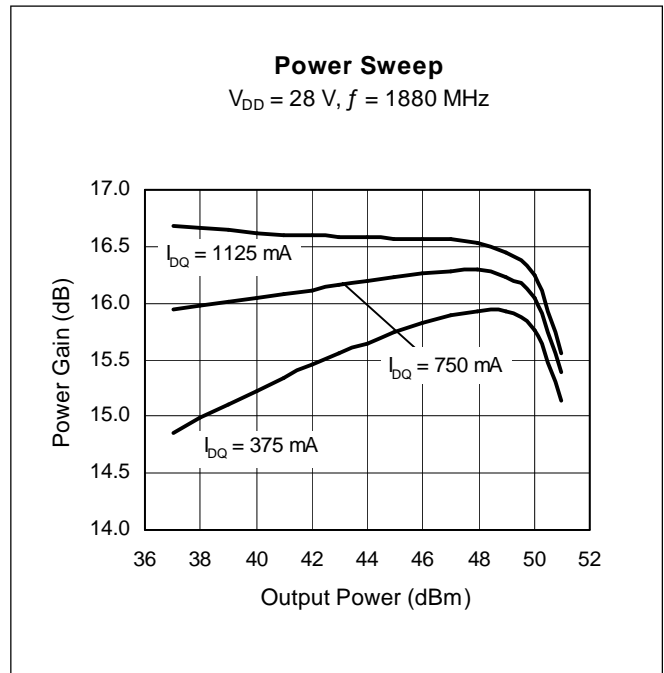
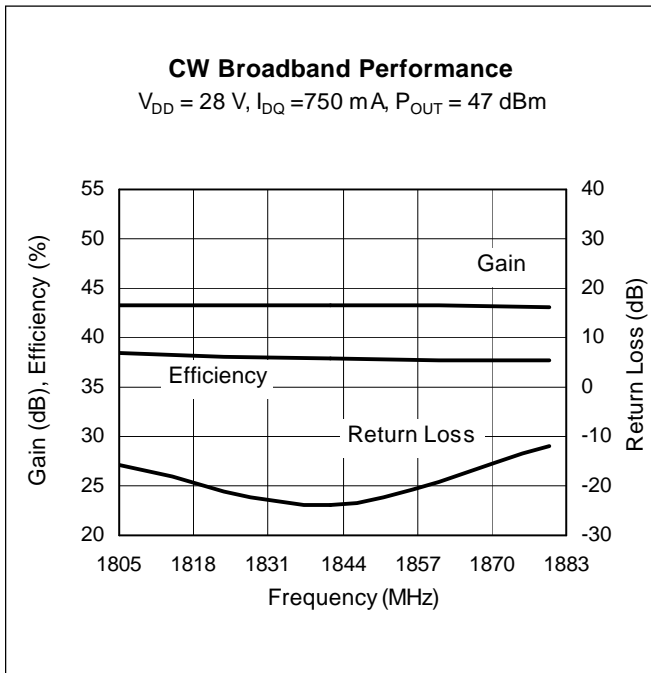
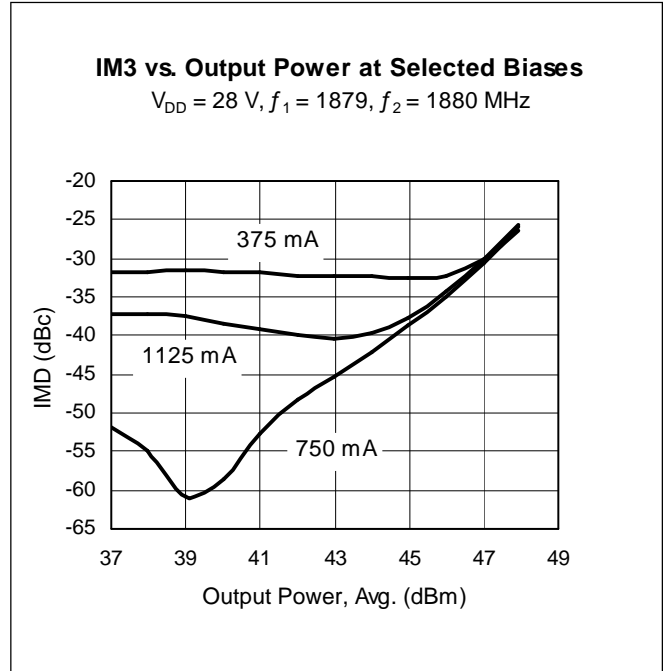
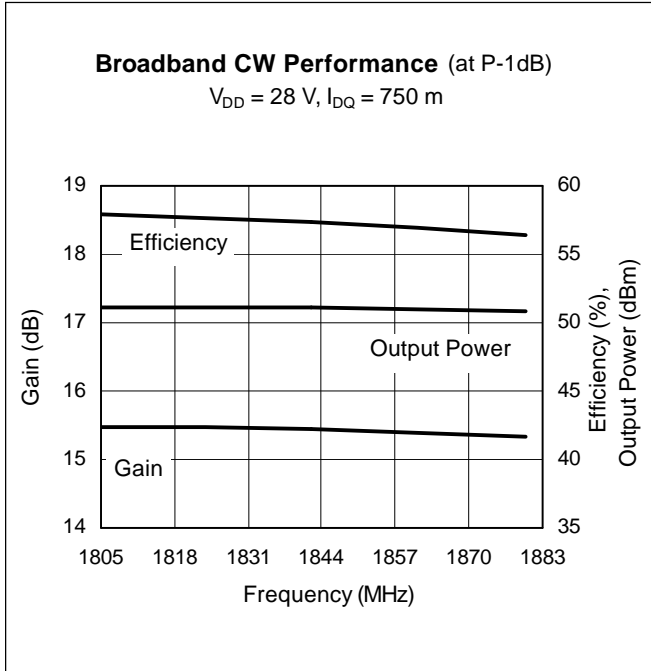

Typical Performance (cont.)

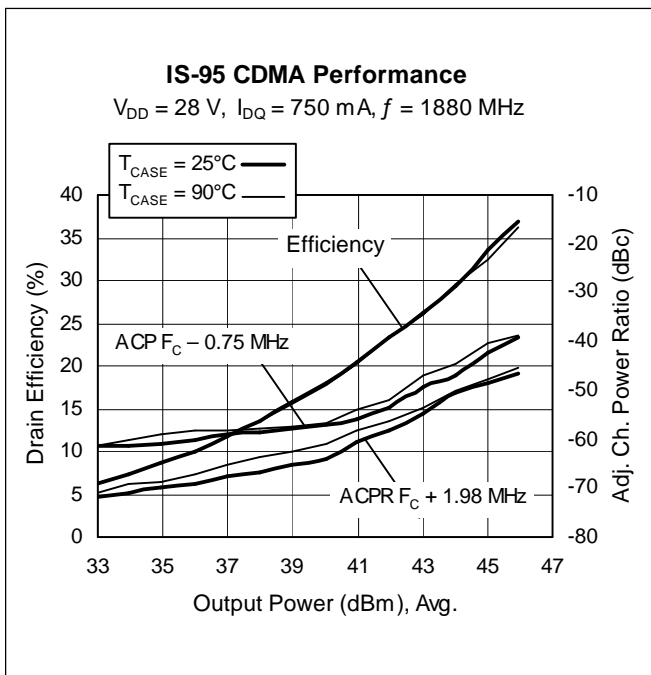
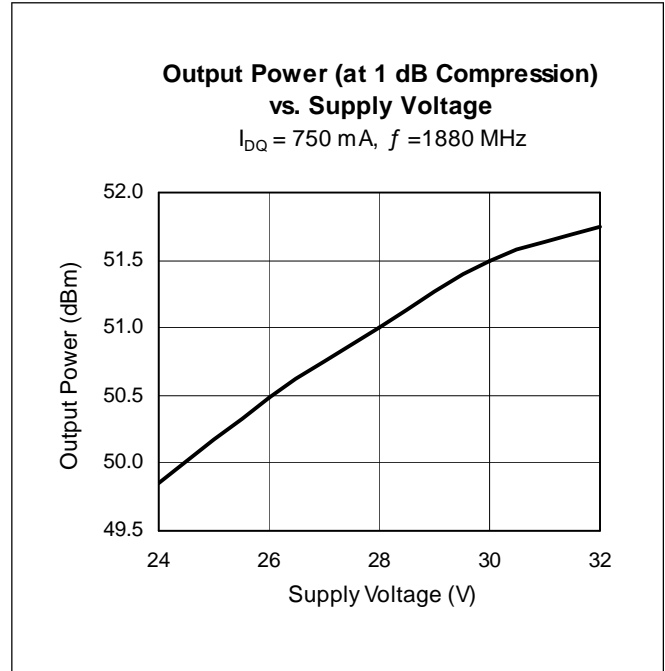
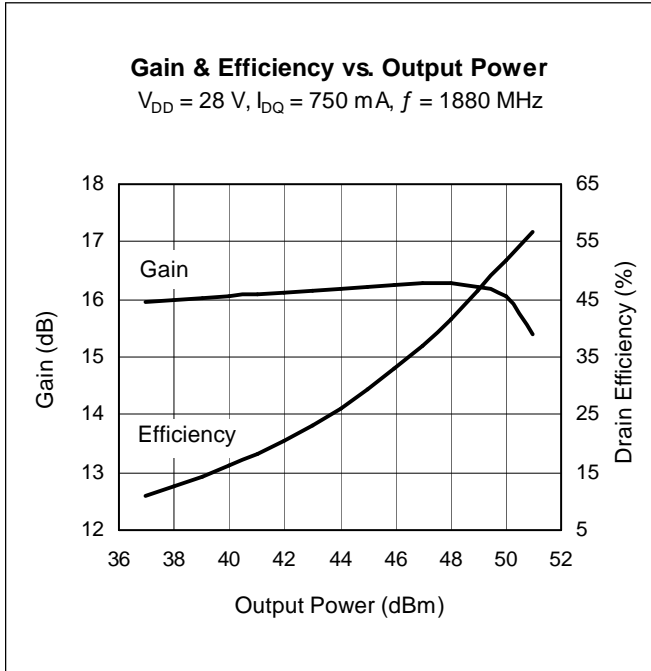

Broadband Circuit Impedance

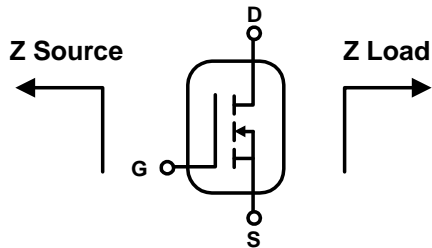

Frequency MHz	Z Source W		Z Load W	
	R	jX	R	jX
1805	4.62	-6.23	1.50	-3.87
1830	4.18	-6.10	1.51	-3.46
1850	4.20	-6.13	1.50	-3.16
1860	4.58	-6.20	1.49	-3.00
1880	4.42	-6.36	1.48	-2.62

See next page for reference circuit

Reference Circuit

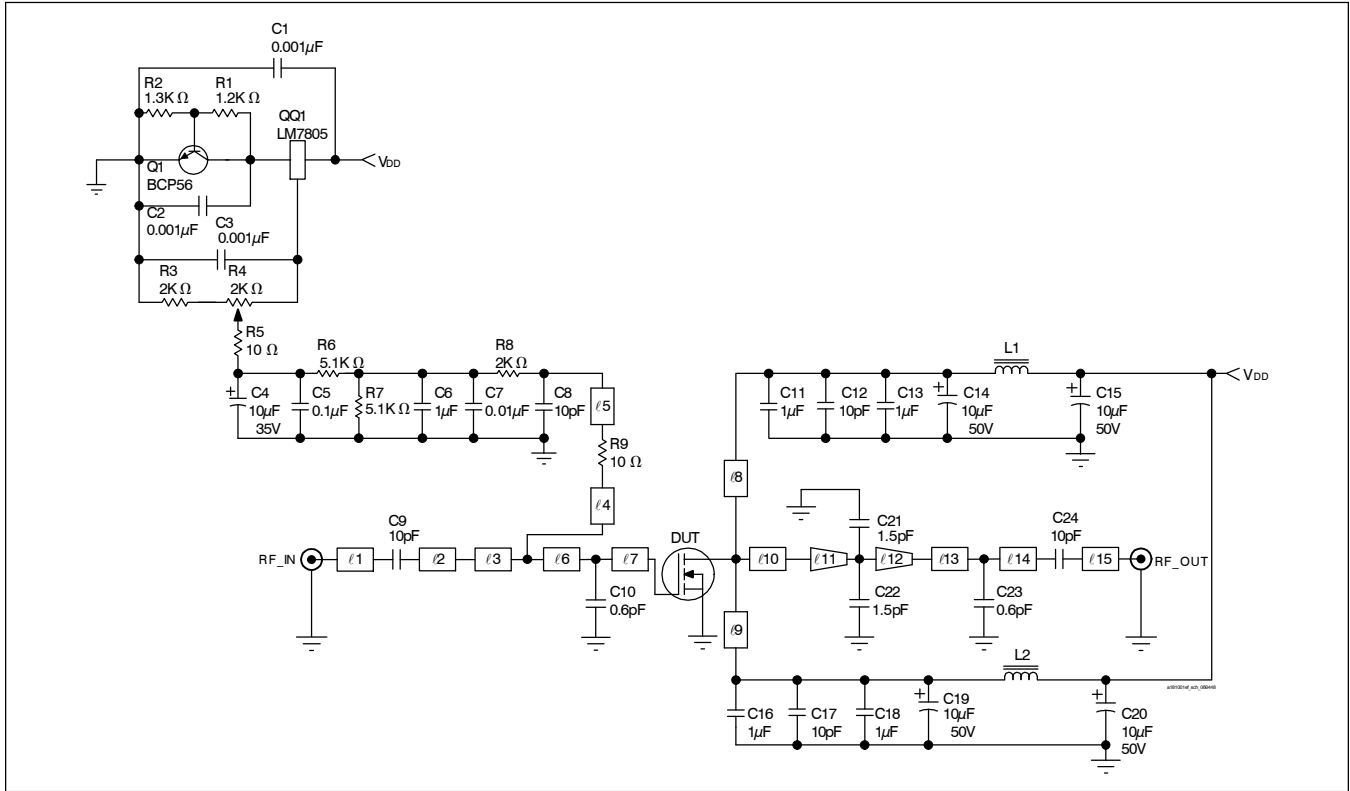

Reference circuit schematic for $f = 1880 \text{ MHz}$

Circuit Assembly Information

DUT	PTFA181001GL or PTFA181001HL	LDMOS Transistor	
PCB	0.76 mm [.030"] thick, $\epsilon_r = 4.5$	Rogers TMM4	2 oz. copper

Microstrip	Electrical Characteristics at 1880 MHz ¹	Dimensions: L x W (mm)	Dimensions: L x W (in.)
l1	0.314 λ , 50.0 Ω	27.43 x 1.37	1.080 x 0.054
l2	0.172 λ , 38.0 Ω	14.73 x 2.16	0.580 x 0.085
l3	0.016 λ , 11.4 Ω	1.27 x 10.16	0.050 x 0.400
l4	0.024 λ , 60.0 Ω	2.24 x 0.99	0.088 x 0.039
l5	0.218 λ , 60.0 Ω	19.33 x 0.99	0.761 x 0.039
l6	0.019 λ , 6.9 Ω	1.52 x 17.78	0.060 x 0.700
l7	0.044 λ , 6.9 Ω	3.43 x 17.78	0.135 x 0.700
l8, l9	0.233 λ , 53.0 Ω	20.45 x 1.24	0.805 x 0.049
l10	0.039 λ , 4.9 Ω	3.10 x 25.65	0.122 x 1.010
l11 (taper)	0.037 λ , 4.9 Ω / 10.3 Ω	2.92 x 25.65 / 11.43	0.115 x 1.010 / 0.450
l12 (taper)	0.033 λ , 10.3 Ω / 41.0 Ω	2.79 x 11.43 / 1.91	0.110 x 0.450 / 0.075
l13	0.069 λ , 41.0 Ω	6.35 x 1.91	0.250 x 0.075
l14	0.038 λ , 41.0 Ω	3.25 x 1.91	0.128 x 0.075
l15	0.331 λ , 50.0 Ω	28.98 x 1.37	1.141 x 0.054

¹Electrical characteristics are rounded.

Reference Circuit (cont.)

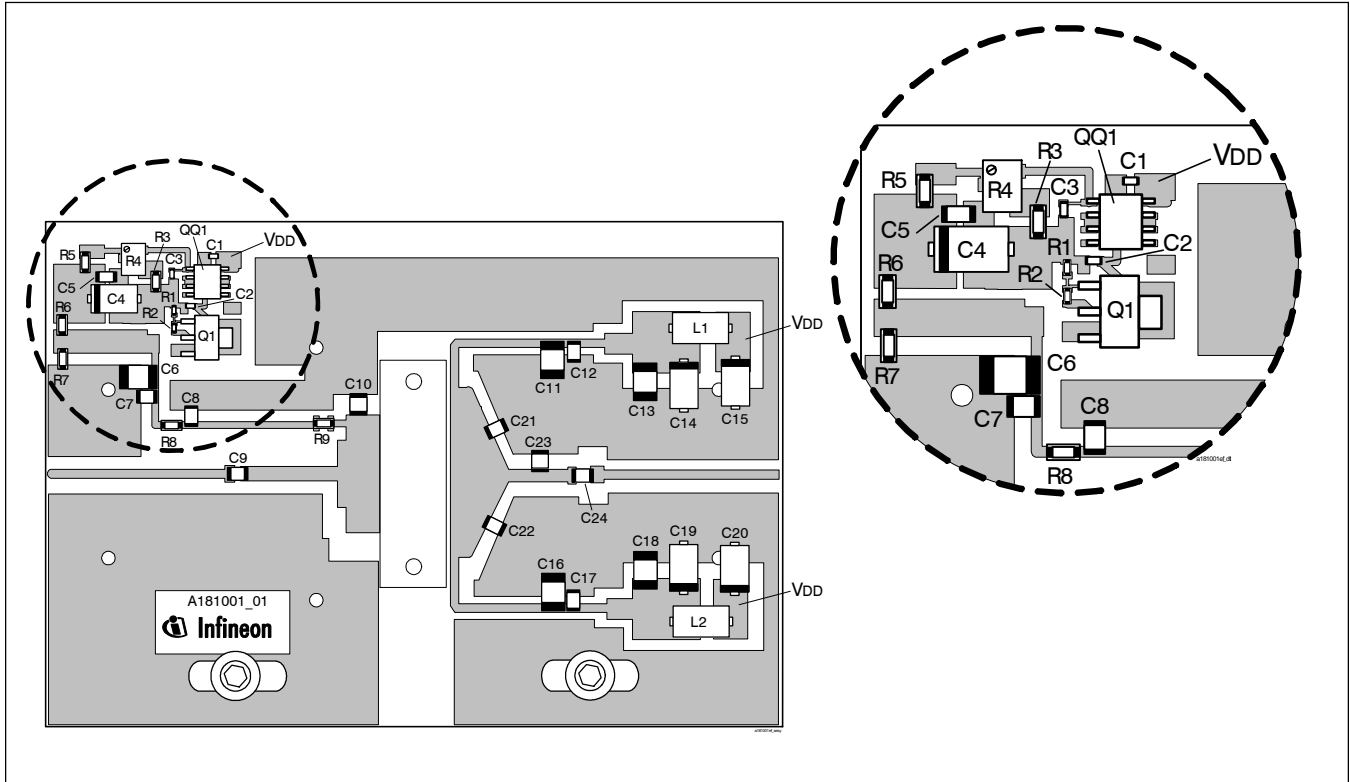

Reference circuit assembly diagram* (not to scale)

Component	Description	Suggested Manufacturer	P/N or Comment
C1, C2, C3	Capacitor, 0.001 μ F	Digi-Key	PCC1772CT-ND
C4	Tantalum capacitor, 10 μ F, 35 V	Digi-Key	399-1655-2-ND
C5	Capacitor, 0.1 μ F	Digi-Key	PCC104BCT-ND
C6, C11, C13, C16, C18	Capacitor, 1.0 μ F	ATC	920C105
C7	Capacitor, 0.01 μ F	ATC	200B 103
C8, C9, C12, C17, C24	Ceramic capacitor, 10 pF	ATC	100B 100
C10, C23	Ceramic capacitor, 0.6 pF	ATC	100B 0R6
C14, C15, C19, C20	Tantalum capacitor, 10 μ F, 50 V	Garrett Electronics	TPSE106K050R0400
C21, C22	Ceramic capacitor, 1.5 pF	ATC	100B 1R5
L1, L2	Ferrite, 8.9 mm	Elna Magnetics	BDS 4.6/3/8.9-4S2
Q1	Transistor	Infinion Technologies	BCP56
QQ1	Voltage regulator	National Semiconductor	LM7805
R1	Chip Resistor 1.2 k-ohms	Digi-Key	P1.2KGCT-ND
R2	Chip Resistor 1.3 k-ohms	Digi-Key	P1.3KGCT-ND
R3, R8	Chip Resistor 2 k-ohms	Digi-Key	P2KECT-ND
R4	Potentiometer 2 k-ohms	Digi-Key	3224W-202ETR-ND
R5, R9	Chip Resistor 10 ohms	Digi-Key	P10ECT-ND
R6, R7	Chip Resistor 5.1 k-ohms	Digi-Key	P5.1KECT-ND

*Gerber files for this circuit available on request

Package Outline Specifications (cont.)

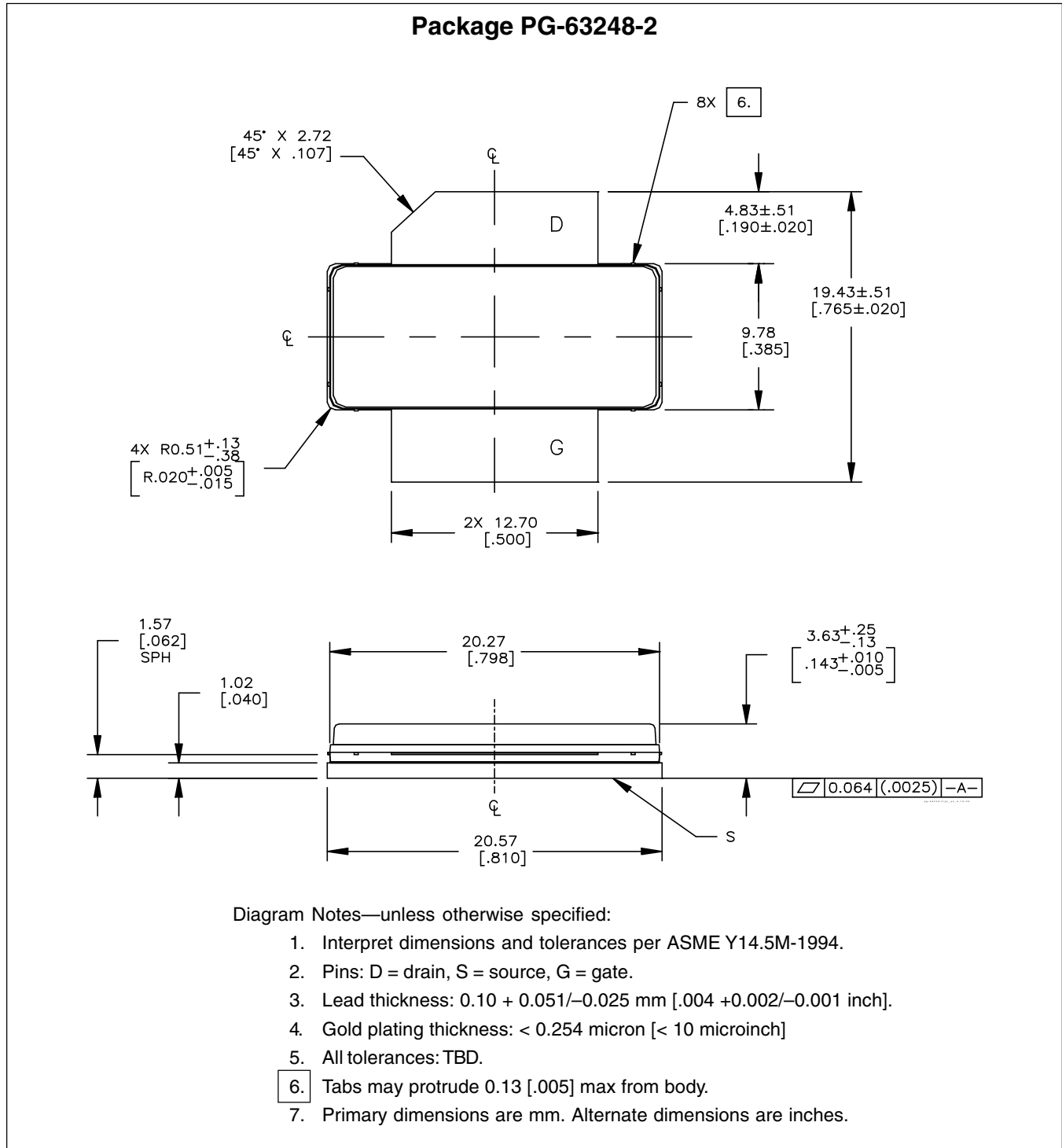

Find the latest and most complete information about products and packaging at the Infineon Internet page
<http://www.infineon.com/rfpower>

Page	Subjects (major changes since last revision)

We Listen to Your Comments

Any information within this document that you feel is wrong, unclear or missing at all? Your feedback will help us to continuously improve the quality of this document.

Please send your proposal (including a reference to this document) to:

highpowerRF@infineon.com

To request other information, contact us at:
+1 877 465 3667 (1-877-GO-LDMOS) USA
or +1 408 776 0600 International

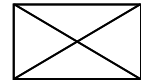

Edition 2008-06-15

Published by
Infineon Technologies AG
81726 Munich, Germany

© 2008 Infineon Technologies AG
All Rights Reserved.

Legal Disclaimer

The information given in this document shall in no event be regarded as a guarantee of conditions or characteristics. With respect to any examples or hints given herein, any typical values stated herein and/or any information regarding the application of the device, Infineon Technologies hereby disclaims any and all warranties and liabilities of any kind, including without limitation, warranties of non-infringement of intellectual property rights of any third party.

Information

For further information on technology, delivery terms and conditions and prices, please contact the nearest Infineon Technologies Office (www.infineon.com/rfpower).

Warnings

Due to technical requirements, components may contain dangerous substances. For information on the types in question, please contact the nearest Infineon Technologies Office.

Infineon Technologies components may be used in life-support devices or systems only with the express written approval of Infineon Technologies, if a failure of such components can reasonably be expected to cause the failure of that life-support device or system or to affect the safety or effectiveness of that device or system. Life support devices or systems are intended to be implanted in the human body or to support and/or maintain and sustain and/or protect human life. If they fail, it is reasonable to assume that the health of the user or other persons may be endangered.