

Single-chip Type with Built-in FET Switching Regulator Series

Output 1.5A or Less High Efficiency Step-down Switching Regulator with Built-in Power MOSFET

BD9150MUV

No.10027ECT13

●Description

ROHM's high efficiency dual step-down switching regulator BD9150MUV is a 2ch output power supply designed to produce a low voltage including 3.3, 1.2 volts from 5.0 volts power supply line. Offers high efficiency with our original pulse skip control technology and synchronous rectifier. Employs a current mode control system to provide faster transient response to sudden change in load.

●Features

- 1) Offers fast transient response with current mode PWM control system.
- 2) Offers highly efficiency for all load range with synchronous rectifier (Pch/Nch FET) and SLLM™ (Simple Light Load Mode)
- 3) 2ch output power supply.
- 4) Each of EN controls 2ch output.
- 5) Incorporates soft-start function.
- 6) Incorporates ULVO functions.
- 7) Incorporates thermal protection and short-current protection circuit with time delay function.
- 8) Incorporates shutdown function $I_{cc}=0\mu A$ (Typ.)
- 9) Output current max 1.5A/1.5A.
- 10) Employs small surface mount package : VQFN020V4040

●Use

Power supply for LSI including DSP, Micro computer and ASIC

●Absolute Maximum Rating (Ta=25°C)

Parameter	Symbol	Limit	Unit
Vcc Voltage	V _{CC}	-0.3~+7 * ¹	V
EN Voltage	V _{EN1}	-0.3~+7	V
	V _{EN2}	-0.3~+7	V
SW Voltage	V _{SW1}	-0.3~+7	V
	V _{SW2}	-0.3~+7	V
Power Dissipation	Pd1	0.34* ²	W
	Pd2	0.70 * ³	W
	Pd3	1.21 * ⁴	W
	Pd4	3.56* ⁵	W
Operating Temperature Range	Topr	-40~+85	°C
Storage Temperature Range	Tstg	-55~+150	°C
Maximum Junction	Tjmax	+150	°C

*1 Pd should not be exceeded.

*2 IC only

*3 1-layer. mounted on a 74.2mm × 74.2mm × 1.6mm glass-epoxy board, occupied area by copper foil : 10.29mm²

*4 4-layer. mounted on a 74.2mm × 74.2mm × 1.6mm glass-epoxy board, occupied area by copper foil : 10.29mm², in each layers

*5 4-layer. mounted on a 74.2mm × 74.2mm × 1.6mm glass-epoxy board, occupied area by copper foil : 5505mm², in each layers

● Operating Conditions (Ta=-40~+85°C)

Parameter	Symbol	Limit			Unit
		Min.	Typ.	Max.	
Vcc Voltage	Vcc	4.75	5.0	5.5	V
EN Voltage	VEN1	0	-	5.5	V
	VEN2	0	-	5.5	V
Output Voltage range	VOUT2	0.8	-	2.5	V
SW Average Output Current	ISW1	-	-	1.5* ⁶	A
	ISW2	-	-	1.5* ⁶	A

*6 Pd and ASO should not be exceeded.

● Electrical Characteristics

◎ (Ta=25°C AVcc=PVcc=5.0V, EN1=EN2=AVcc ,unless otherwise specified.)

Parameter	Symbol	Limit			Unit	Condition
		Min.	Typ.	Max.		
Standby Current	ISTB	-	0	10	μA	EN1=EN2=0V
Bias Current	ICC	-	500	800	μA	
EN Low Voltage	VENL	-	GND	0.8	V	Standby Mode
EN High Voltage	VENH	2.0	Vcc	-	V	Active Mode
EN Input Current	IEN	-	1	10	μA	VEN1=VEN2=2V
Oscillation Frequency	FOSC	1.2	1.5	1.8	MHz	
Pch FET ON Resistance	RONP1	-	0.17	0.3	Ω	Vcc=5V
	RONP2	-	0.17	0.3	Ω	Vcc=5V
Nch FET ON Resistance	RONN1	-	0.13	0.2	Ω	Vcc=5V
	RONN2	-	0.13	0.2	Ω	Vcc=5V
FB Reference Voltage	FB1	3.25	3.3	3.35	V	±1.5%
	FB2	0.788	0.8	0.812	V	±1.5%
UVLO Threshold Voltage	VUVLO1	3.6	3.8	4.0	V	Vcc=5→0V
UVLO Release Voltage	VUVLO2	3.65	3.9	4.2	V	Vcc=0→5V
Soft Start Time	TSS	0.4	0.8	1.6	ms	
Timer Latch Time	TLATCH	0.68	1.36	2.72	ms	SCP/TSD ON
Output Short circuit Threshold Voltage	VSCP1	-	1.65	2.4	V	FB1=3.3→0V
	VSCP2	-	0.4	0.56	V	FB2=0.8→0V

●Block Diagram, Application Circuit

【BD9150MUV】

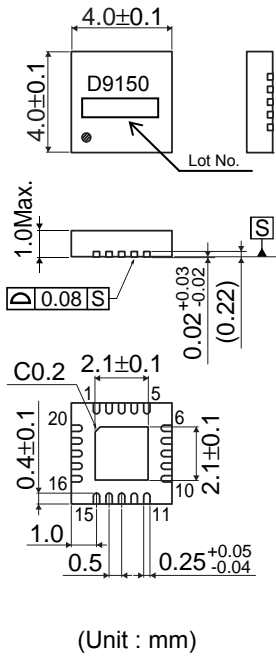

Fig.1 BD9150MUV TOP View

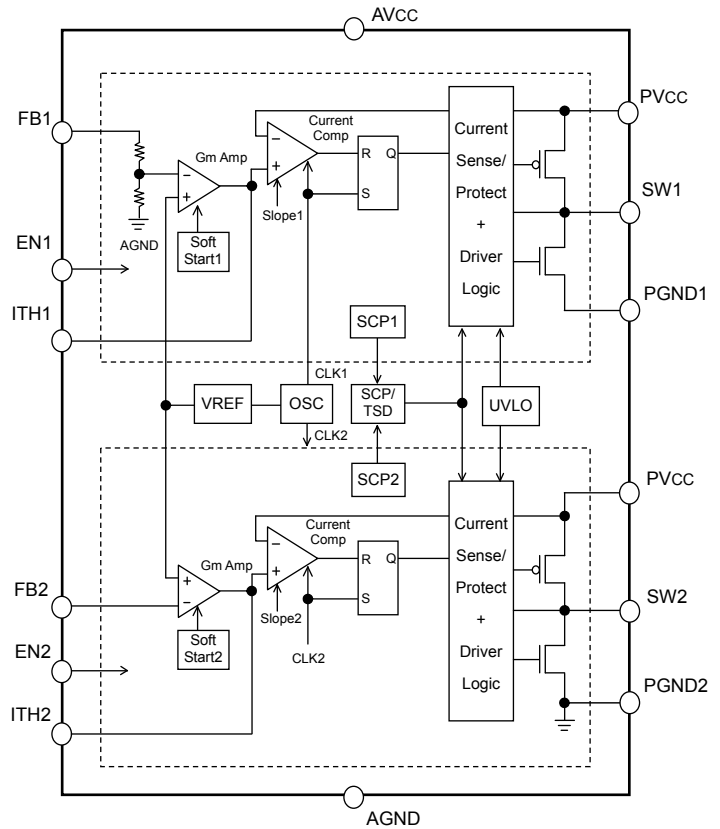

Fig.2 BD9150MUV Block Diagram

●Pin No. & function table

Pin No.	Pin name	Function	Pin No.	Pin name	Function
1	PGND2	Ch2 Lowside source pin	11	ITH1	Ch1 GmAmp output pin/Connected phase compensation capacitor
2	PVcc	Highside FET source pin	12	AGND	Ground
3	PVcc	Highside FET source pin	13	N.C.	Non Connection
4	PVcc	Highside FET source pin	14	AVcc	VCC power supply input pin
5	PGND1	Ch1 Lowside source pin	15	ITH2	Ch1 GmAmp output pin/Connected phase compensation capacitor
6	PGND1	Ch1 Lowside source pin	16	FB2	Ch2 output voltage detect pin
7	SW1	Ch1 Pch/Nch FET drain output pin	17	EN2	Ch2 Enable pin(High Active)
8	SW1	Ch1 Pch/Nch FET drain output pin	18	SW2	Ch2 Pch/Nch FET drain output pin
9	EN1	Ch1 Enable pin(High Active)	19	SW2	Ch2 Pch/Nch FET drain output pin
10	FB1	Ch1 output voltage detect pin	20	PGND2	Ch2 Lowside source pin

● Characteristics data

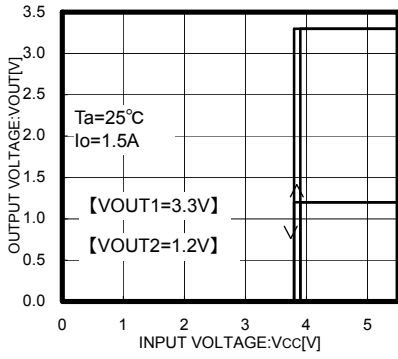

Fig.3 Vcc - V_{OUT}

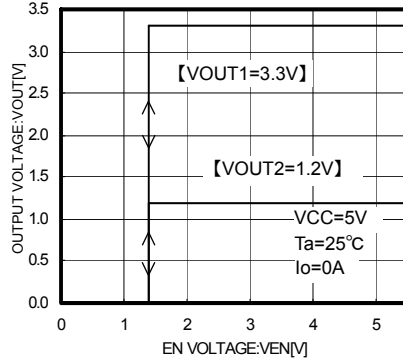

Fig.4 V_{EN} - V_{OUT}

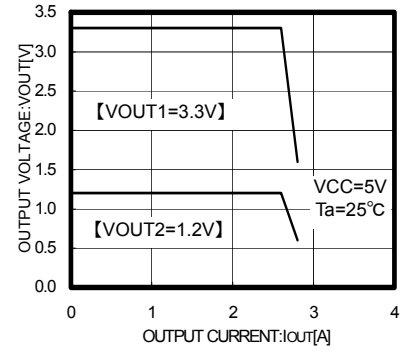

Fig.5 I_{OUT} - V_{OUT}

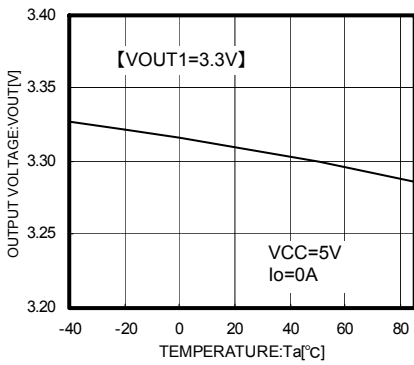

Fig.6 Ta - V_{OUT}

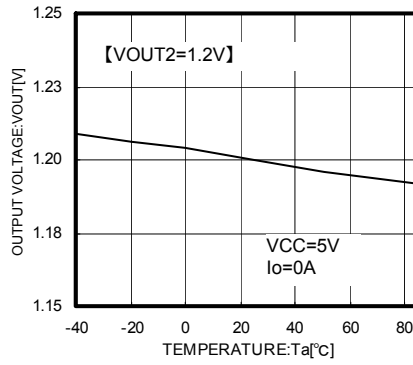

Fig.7 Ta - V_{OUT}

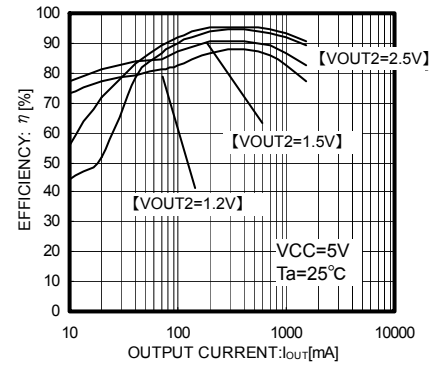

Fig.8 Efficiency

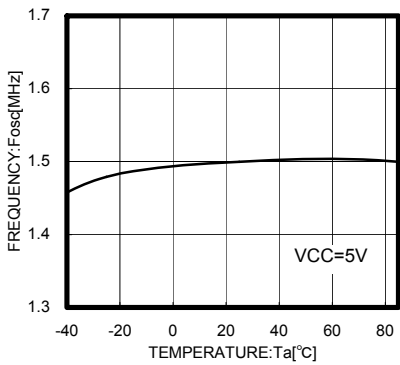

Fig.9 Ta - F_{osc}

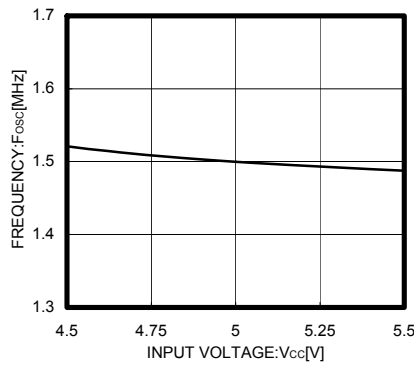

Fig.10 V_{cc} - F_{osc}

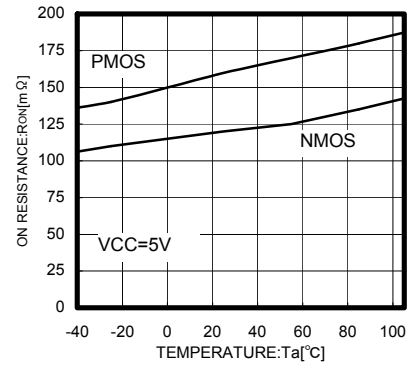

Fig.11 Ta - RON_N, RON_P

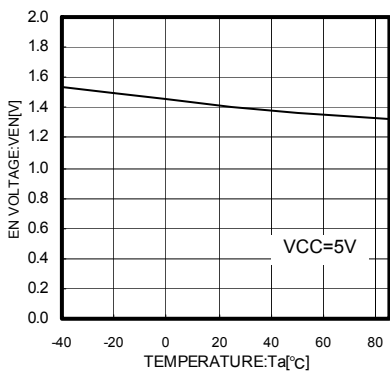

Fig.12 Ta - V_{EN}

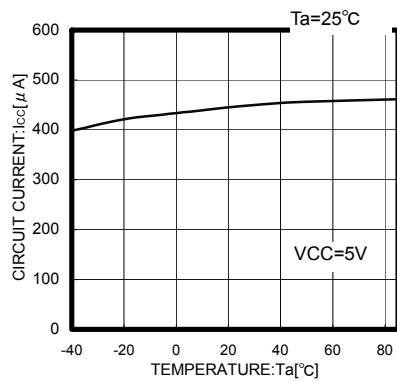

Fig.13 Ta - I_{CC}

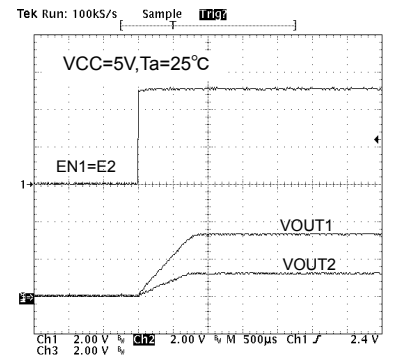

Fig.14 Soft start waveform (I_o=0mA)

●Characteristics data [BD9150MUV]

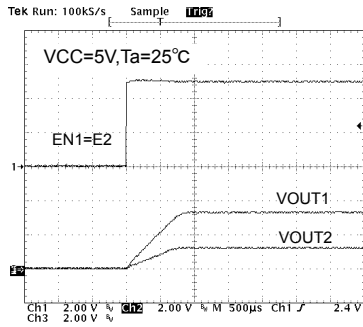

Fig.15 Soft start waveform (Io=1.5A)

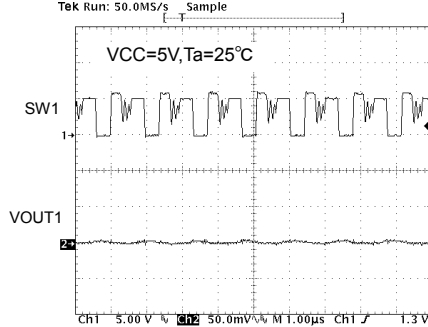

Fig.16 SW1 waveform (Io=0mA)

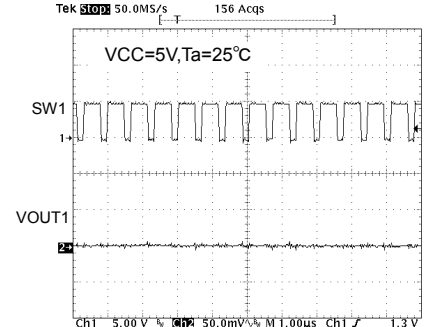

Fig.17 SW1 waveform (Io=1.5A)

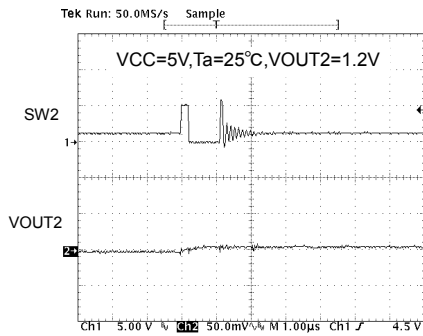

Fig.18 SW2 waveform (Io=0mA)

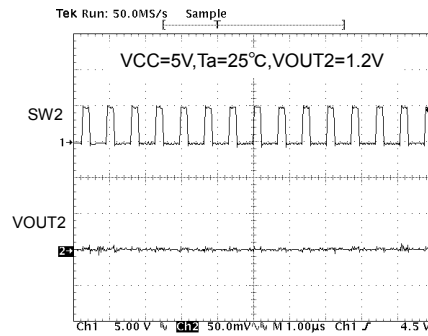

Fig.19 SW2 waveform (Io=1.5A)

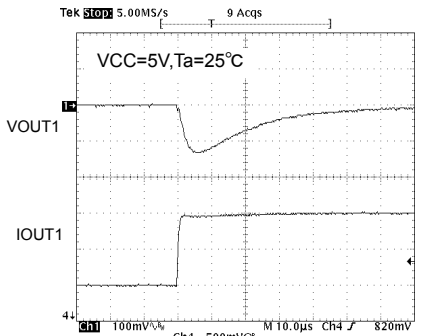

Fig.20 VOUT1 Transient Response (Io0.5A→1.5A / usec)

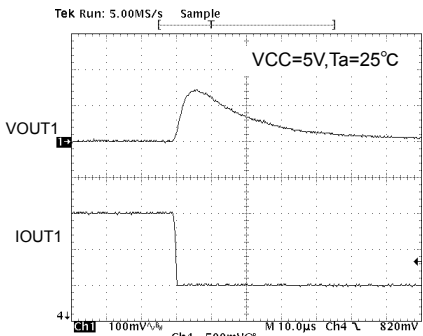

Fig.21 VOUT1 Transient Response (Io1.5A→0.5A/ usec)

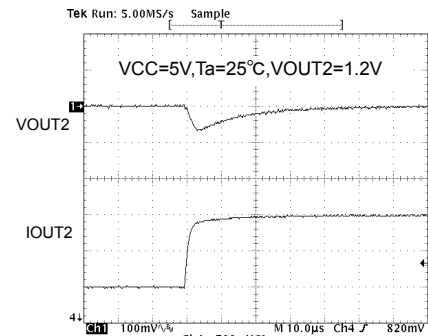

Fig.22 VOUT2 Transient Response (Io0.5A→1.5A/ usec)

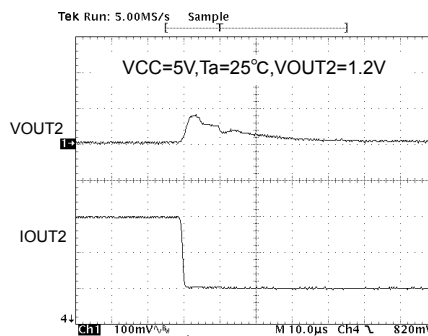
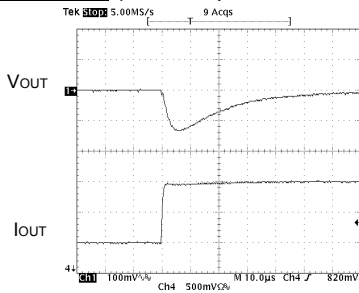

Fig.23 VOUT2 Transient Response (Io1.5A→0.5A/ usec)

● Information on advantages

Advantage 1 : Offers fast transient response with current mode control system.

BD9150MUV (Load response $I_o=0.5A \rightarrow 1.5A$)



BD9150MUV (Load response $I_o=1.5A \rightarrow 0.5A$)

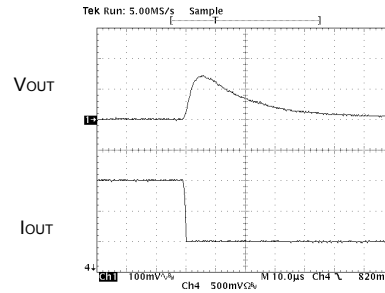

Fig.24 Transient response

Advantage 2 : Offers high efficiency for all load range.

• For lighter load:

Utilizes the current mode control mode called SLLM for lighter load, which reduces various dissipation such as switching dissipation (P_{SW}), gate charge/discharge dissipation, ESR dissipation of output capacitor (P_{ESR}) and on-resistance dissipation (P_{RON}) that may otherwise cause degradation in efficiency for lighter load.



Achieves efficiency improvement for lighter load.

• For heavier load:

Utilizes the synchronous rectifying mode and the low on-resistance MOS FETs incorporated as power transistor.

- { ON resistance of Highside MOS FET : 170mΩ (Typ.)
- { ON resistance of Lowside MOS FET : 130mΩ (Typ.)



Achieves efficiency improvement for heavier load.

Offers high efficiency for all load range with the improvements mentioned above.

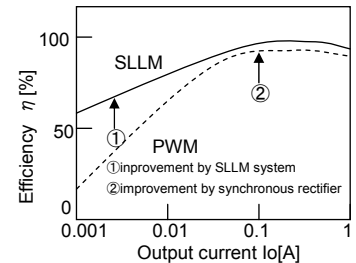

Fig.25 Efficiency

Advantage 3 : • Supplied in smaller package due to small-sized power MOS FET incorporated.



Reduces a mounting area required.

- Output capacitor C_o required for current mode control: 22 μ F ceramic capacitor
- Inductance L required for the operating frequency of 1 MHz: 2.2 μ H inductor
- Incorporates FET + Boot strap diode

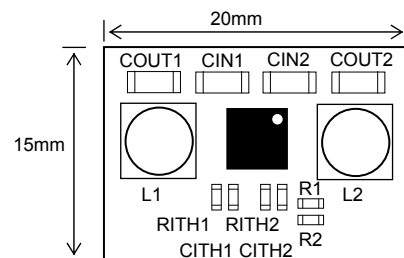
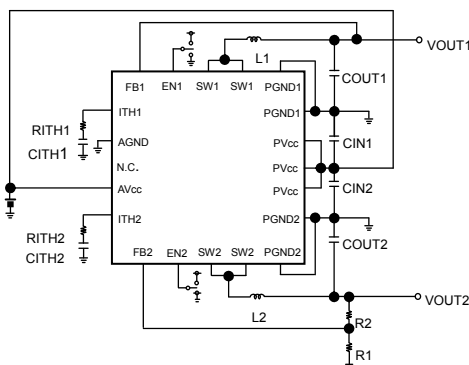

Fig.26 Example application

● Operation

BD9150MUV is a synchronous rectifying step-down switching regulator that achieves faster transient response by employing current mode PWM control system. It utilizes switching operation in PWM (Pulse Width Modulation) mode for heavier load, while it utilizes SLLM (Simple Light Load Mode) operation for lighter load to improve efficiency.

○ Synchronous rectifier

It does not require the power to be dissipated by a rectifier externally connected to a conventional DC/DC converter IC, and its P.N junction shoot-through protection circuit limits the shoot-through current during operation, by which the power dissipation of the set is reduced.

○ Current mode PWM control

Synthesizes a PWM control signal with an inductor current feedback loop added to the voltage feedback.

• PWM (Pulse Width Modulation) control

The oscillation frequency for PWM is 1 MHz. SET signal from OSC turns ON a highside MOS FET (while a lowside MOS FET is turned OFF), and an inductor current I_L increases. The current comparator (Current Comp) receives two signals, a current feedback control signal (SENSE: Voltage converted from I_L) and a voltage feedback control signal (FB), and issues a RESET signal if both input signals are identical to each other, and turns OFF the highside MOS FET (while a lowside MOS FET is turned ON) for the rest of the fixed period. The PWM control repeat this operation.

• SLLM (Simple Light Load Mode) control

When the control mode is shifted from PWM for heavier load to the one for lighter load or vice versa, the switching pulse is designed to turn OFF with the device held operated in normal PWM control loop, which allows linear operation without voltage drop or deterioration in transient response during the mode switching from light load to heavy load or vice versa. Although the PWM control loop continues to operate with a SET signal from OSC and a RESET signal from Current Comp, it is so designed that the RESET signal is held issued if shifted to the light load mode, with which the switching is tuned OFF and the switching pulses are thinned out under control. Activating the switching intermittently reduces the switching dissipation and improves the efficiency.

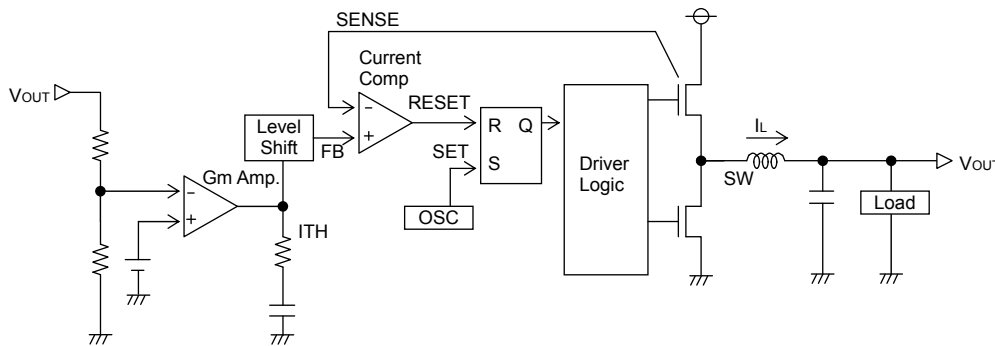

Fig.27 Diagram of current mode PWM control

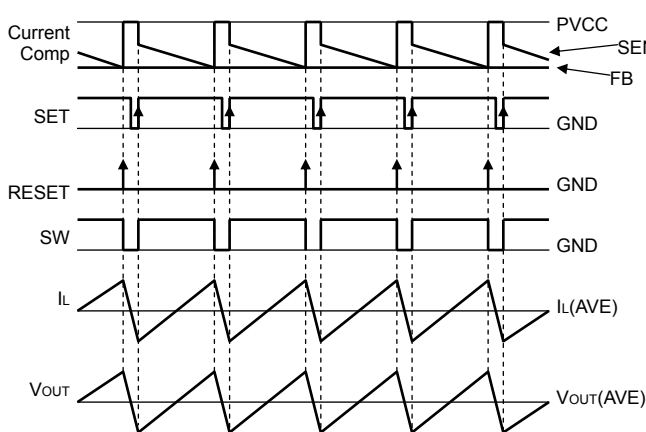

Fig.28 PWM switching timing chart

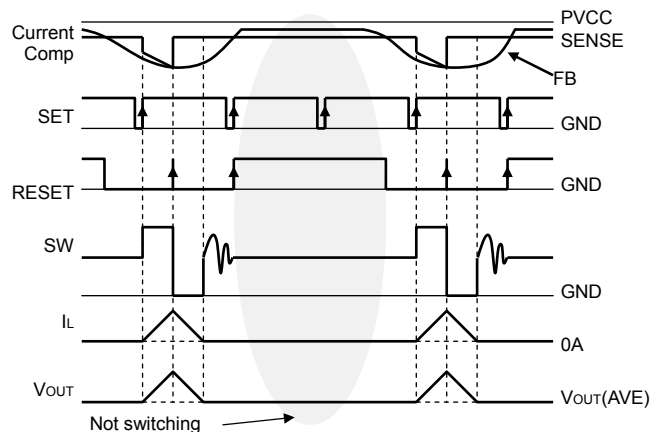

Fig.29 SLLM™ switching timing chart

●Description of operations

• Soft-start function

EN terminal shifted to “High” activates a soft-starter to gradually establish the output voltage with the current limited during startup, by which it is possible to prevent an overshoot of output voltage and an inrush current.

• Shutdown function

With EN terminal shifted to “Low”, the device turns to Standby Mode, and all the function blocks including reference voltage circuit, internal oscillator and drivers are turned to OFF. Circuit current during standby is $0\mu F$ (Typ.).

• UVLO function

Detects whether the input voltage sufficient to secure the output voltage of this IC is supplied. And the hysteresis width of 100mV (Typ.) is provided to prevent output chattering.

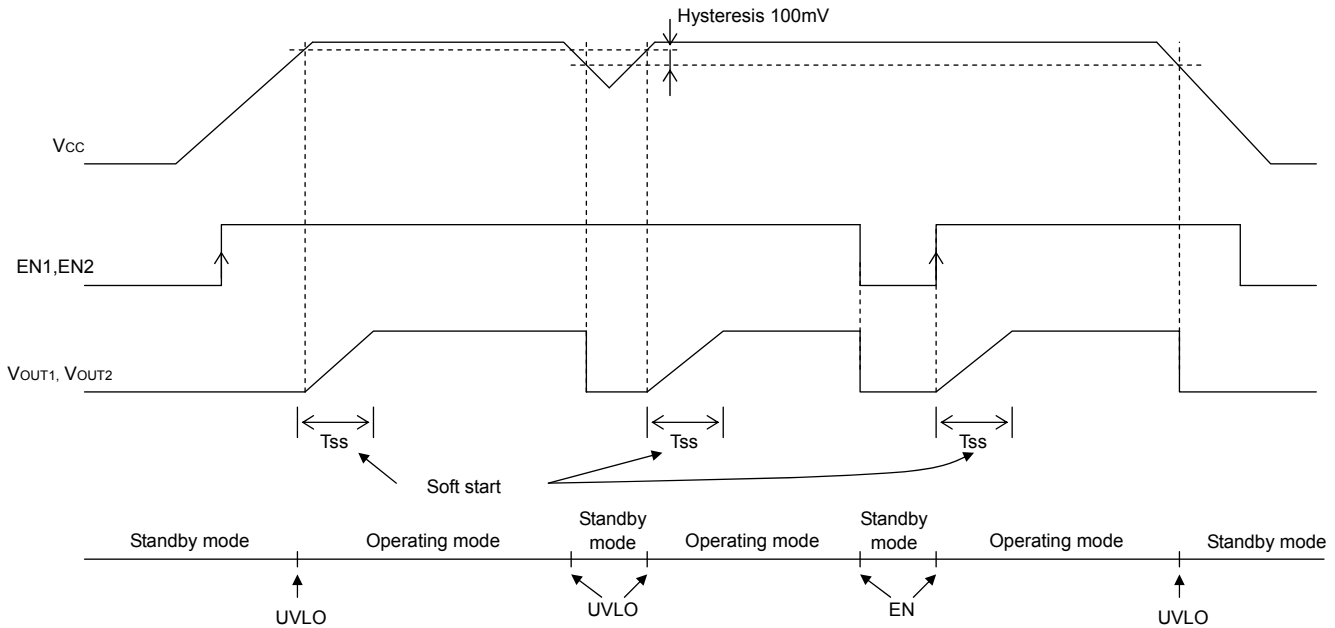

Fig.30 Soft start, Shutdown, UVLO timing chart

• Short-current protection circuit with time delay function

Turns OFF the output to protect the IC from breakdown when the incorporated current limiter is activated continuously for the fixed time (T_{LATCH}) or more. The output thus held tuned OFF may be recovered by restarting EN or by re-unlocking UVLO.

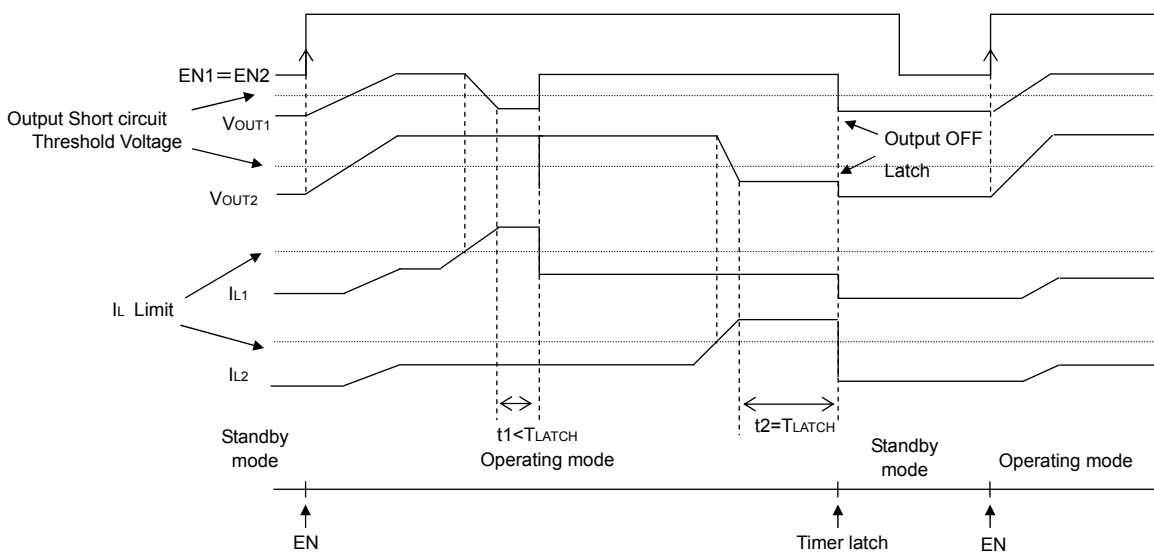

Fig.31 Short-current protection circuit with time delay timing chart

● Switching regulator efficiency

Efficiency η may be expressed by the equation shown below:

$$\eta = \frac{V_{OUT} \times I_{OUT}}{V_{IN} \times I_{IN}} \times 100[\%] = \frac{P_{OUT}}{P_{IN}} \times 100[\%] = \frac{P_{OUT}}{P_{OUT} + P_{D\alpha}} \times 100[\%]$$

Efficiency may be improved by reducing the switching regulator power dissipation factors $P_{D\alpha}$ as follows:

Dissipation factors:

- 1) ON resistance dissipation of inductor and FET : PD(I^2R)
- 2) Gate charge/discharge dissipation : PD(Gate)
- 3) Switching dissipation : PD(SW)
- 4) ESR dissipation of capacitor : PD(ESR)
- 5) Operating current dissipation of IC : PD(IC)

1) PD(I^2R) = $I_{OUT}^2 \times (R_{COIL} + R_{ON})$ ($R_{COIL}[\Omega]$: DC resistance of inductor, $R_{ON}[\Omega]$: ON resistance of FET, $I_{OUT}[A]$: Output current.)

2) PD(Gate) = $C_{GS} \times f \times V$ ($C_{GS}[F]$: Gate capacitance of FET, $f[H]$: Switching frequency, $V[V]$: Gate driving voltage of FET)

3) PD(SW) = $\frac{V_{IN}^2 \times C_{RSS} \times I_{OUT} \times f}{I_{DRIVE}}$ ($C_{RSS}[F]$: Reverse transfer capacitance of FET, $I_{DRIVE}[A]$: Peak current of gate.)

4) PD(ESR) = $I_{RMS}^2 \times ESR$ ($I_{RMS}[A]$: Ripple current of capacitor, $ESR[\Omega]$: Equivalent series resistance.)

5) PD(IC) = $V_{IN} \times I_{CC}$ ($I_{CC}[A]$: Circuit current.)

● Consideration on permissible dissipation and heat generation

As this IC functions with high efficiency without significant heat generation in most applications, no special consideration is needed on permissible dissipation or heat generation. In case of extreme conditions, however, including lower input voltage, higher output voltage, heavier load, and/or higher temperature, the permissible dissipation and/or heat generation must be carefully considered.

For dissipation, only conduction losses due to DC resistance of inductor and ON resistance of FET are considered.

Because the conduction losses are considered to play the leading role among other dissipation mentioned above including gate charge/discharge dissipation and switching dissipation.

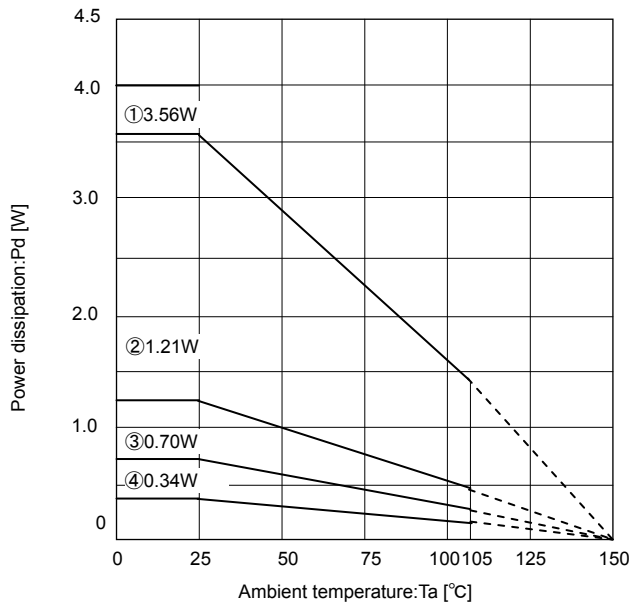

Fig.32 Thermal derating curve (VQFN020V4040)

- ① 4 layers (copper foil area : 5505mm²)
(copper foil in each layers)
 $\theta_{j-a}=32.1^{\circ}\text{C/W}$
- ② 4 layers (copper foil area : 10.29mm²)
(copper foil in each layers)
 $\theta_{j-a}=82.6^{\circ}\text{C/W}$
- ③ 1 layer (copper foil area : 0mm²)
 $\theta_{j-a}=160.1^{\circ}\text{C/W}$
- ④ IC only
 $\theta_{j-a}=249.5^{\circ}\text{C/W}$

$$P=I_{OUT}^2 \times R_{ON}$$

$$R_{ON}=D \times R_{ONP}+(1-D)R_{ONN}$$

D : ON duty (=V_{OUT}/V_{CC})

R_{ONH} : ON resistance of Highside MOS FET

R_{ONL} : ON resistance of Lowside MOS FET

I_{OUT} : Output current

If V_{CC}=5V, V_{OUT1}=3.3V, V_{OUT2}=1.2V, R_{ONH}=170mΩ, R_{ONL}=130mΩ

I_{OUT}=1.5A, for example,

$$D_1=V_{OUT1}/V_{CC}=3.3/5=0.66$$

$$D_2=V_{OUT2}/V_{CC}=1.2/5=0.24$$

$$R_{ON1}=0.66 \times 0.170+(1-0.66) \times 0.130$$

$$=0.1122+0.0442$$

$$=0.1564[\Omega]$$

$$R_{ON2}=0.24 \times 0.170+(1-0.24) \times 0.130$$

$$=0.0408+0.0988$$

$$=0.1397[\Omega]$$

$$P=1.5^2 \times 0.1564+1.5^2 \times 0.1397=0.666[\text{W}]$$

As R_{ONH} is greater than R_{ONL} in this IC, the dissipation increases as the ON duty becomes greater. With the consideration on the dissipation as above, thermal design must be carried out with sufficient margin allowed.

● Selection of components externally connected

1. Selection of inductor (L)

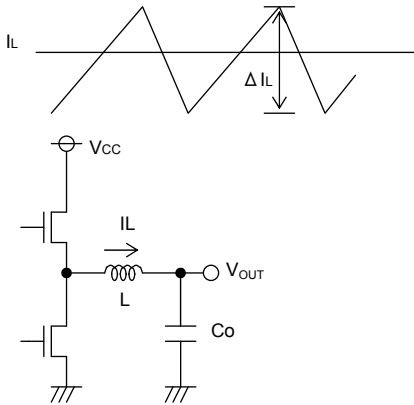

Fig.33 Output ripple current

The inductance significantly depends on output ripple current. As seen in the equation (1), the ripple current decreases as the inductor and/or switching frequency increases.

$$\Delta I_L = \frac{(V_{CC} - V_{OUT}) \times V_{OUT}}{L \times V_{CC} \times f} \text{ [A]} \dots (1)$$

Appropriate ripple current at output should be 20% more or less of the maximum output current.

$$\Delta I_L = 0.2 \times I_{OUTmax.} \text{ [A]} \dots (2)$$

$$L = \frac{(V_{CC} - V_{OUT}) \times V_{OUT}}{\Delta I_L \times V_{CC} \times f} \text{ [H]} \dots (3)$$

(ΔI_L : Output ripple current, and f: Switching frequency)

※ Current exceeding the current rating of the inductor results in magnetic saturation of the inductor, which decreases efficiency. The inductor must be selected allowing sufficient margin with which the peak current may not exceed its current rating.

If $V_{CC}=5.0V$, $V_{OUT}=1.2V$, $f=1.5MHz$, $\Delta I_L=0.2 \times 1.5A=0.3A$, for example, (BD9150MUV)

$$L = \frac{(5-1.2) \times 1.2}{0.3 \times 5 \times 1.5M} = 2.02 \mu \rightarrow 2.2[\mu H]$$

※ Select the inductor of low resistance component (such as DCR and ACR) to minimize dissipation in the inductor for better efficiency.

2. Selection of output capacitor (Co)

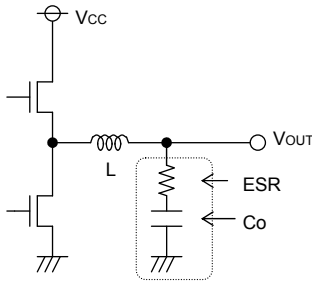

Fig.34 Output capacitor

Output capacitor should be selected with the consideration on the stability region and the equivalent series resistance required to smooth ripple voltage.

Output ripple voltage is determined by the equation (4) :

$$\Delta V_{OUT} = \Delta I_L \times ESR \text{ [V]} \dots (4)$$

(ΔI_L : Output ripple current, ESR: Equivalent series resistance of output capacitor)

※ Rating of the capacitor should be determined allowing sufficient margin against output voltage. A $22 \mu F$ to $100 \mu F$ ceramic capacitor is recommended. Less ESR allows reduction in output ripple voltage.

3. Selection of input capacitor (Cin)

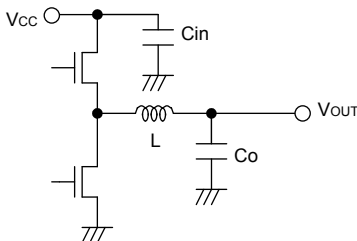

Fig.35 Input capacitor

Input capacitor to select must be a low ESR capacitor of the capacitance sufficient to cope with high ripple current to prevent high transient voltage. The ripple current IRMS is given by the equation (5):

$$I_{RMS} = I_{OUT} \times \frac{\sqrt{V_{OUT}(V_{CC} - V_{OUT})}}{V_{CC}} \text{ [A]} \dots (5)$$

< Worst case > $I_{RMS(max.)}$

$$\text{When } V_{CC} = 2 \times V_{OUT}, I_{RMS} = \frac{I_{OUT}}{2}$$

If $V_{CC}=5.0V$, $V_{OUT}=1.2V$, and $I_{OUTmax.}=1.5A$, (BD9150MUV)

$$I_{RMS} = 2 \times \frac{\sqrt{1.2(5.0-1.2)}}{5.0} = 0.85[\text{ARMS}]$$

A low ESR $22 \mu F/10V$ ceramic capacitor is recommended to reduce ESR dissipation of input capacitor for better efficiency.

4. Determination of RITH, CITH that works as a phase compensator

As the Current Mode Control is designed to limit a inductor current, a pole (phase lag) appears in the low frequency area due to a CR filter consisting of a output capacitor and a load resistance, while a zero (phase lead) appears in the high frequency area due to the output capacitor and its ESR. So, the phases are easily compensated by adding a zero to the power amplifier output with C and R as described below to cancel a pole at the power amplifier.

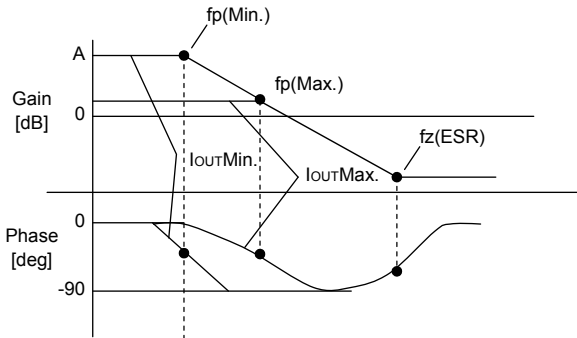

Fig.36 Open loop gain characteristics

$$f_p = \frac{1}{2\pi \times R_O \times C_O}$$

$$f_z(\text{ESR}) = \frac{1}{2\pi \times \text{ESR} \times C_O}$$

Pole at power amplifier

When the output current decreases, the load resistance R_O increases and the pole frequency lowers.

$$f_{p(\text{Min.})} = \frac{1}{2\pi \times R_{O\text{Max.}} \times C_O} \text{ [Hz]} \leftarrow \text{with lighter load}$$

$$f_{p(\text{Max.})} = \frac{1}{2\pi \times R_{O\text{Min.}} \times C_O} \text{ [Hz]} \leftarrow \text{with heavier load}$$

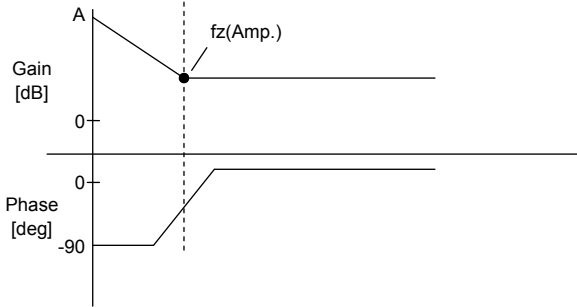

Fig.37 Error amp phase compensation characteristics

Zero at power amplifier

Increasing capacitance of the output capacitor lowers the pole frequency while the zero frequency does not change. (This is because when the capacitance is doubled, the capacitor ESR reduces to half.)

$$f_z(\text{Amp.}) = \frac{1}{2\pi \times R_{\text{ITH}} \times C_{\text{ITH}}}$$

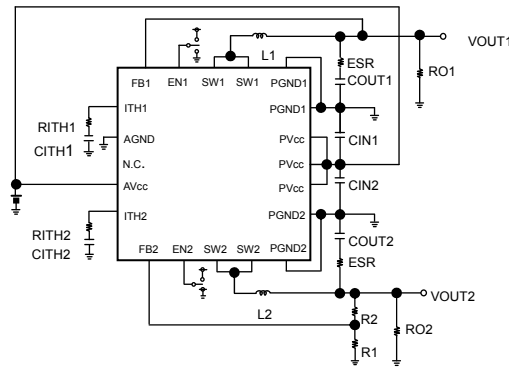

Fig.38 Typical application

Stable feedback loop may be achieved by canceling the pole f_p (Min.) produced by the output capacitor and the load resistance with CR zero correction by the error amplifier.

$$f_z(\text{Amp.}) = f_{p(\text{Min.})} \rightarrow \frac{1}{2\pi \times R_{\text{ITH}} \times C_{\text{ITH}}} = \frac{1}{2\pi \times R_{O\text{Max.}} \times C_O}$$

5. Determination of output voltage

The output voltage V_{out} is determined by the equation (6):
 $V_{OUT} = (R2/R1 + 1) \times V_{ADJ}$. . . (6) V_{ADJ} : Voltage at ADJ terminal (0.8V Typ.)
 With R1 and R2 adjusted, the output voltage may be determined as required.

(Adjustable output voltage range : 0.8V~2.5V)

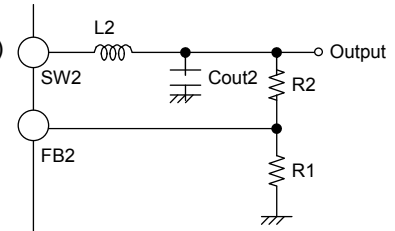

Fig.39 Determination of output voltage

Use 1 kΩ~100 kΩ resistor for R1. If a resistor of the resistance higher than 100 kΩ is used, check the assembled set carefully for ripple voltage etc.

●BD9150MUV Cautions on PC Board layout

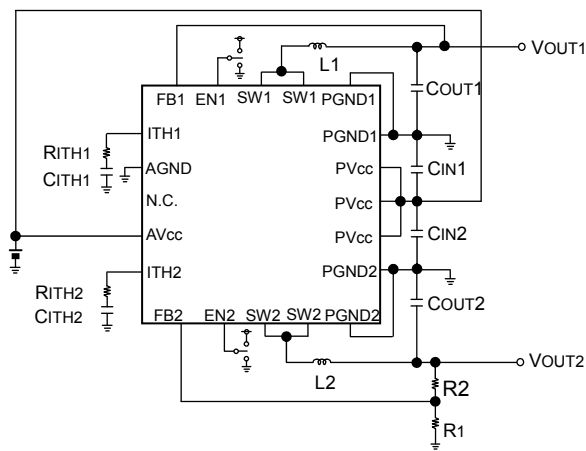

Fig.40 Layout diagram

- ① Lay out the input ceramic capacitor C_{IN} closer to the pins PV_{CC} and $PGND$, and the output capacitor C_o closer to the pin $PGND$.
- ② Lay out C_{ITH} and R_{ITH} between the pins ITH and GND as neat as possible with least necessary wiring.

※ VQFN020V4040 (BD9150MUV) has thermal PAD on the reverse of the package.
 The package thermal performance may be enhanced by bonding the PAD to GND plane which take a large area of PCB.

● Recommended components Lists on above application

Symbol	Part	Value	Manufacturer	Series	
L1,2	Coil	2.2uH	TDK	LTF5022-2R2N3R2	
		2.2uH	TDK	LTF5022-2R2N3R2	
CIN1,CIN2	Ceramic capacitor	22uF	Murata	GRM32EB11A226KE20	
Cout1,Cout2	Ceramic capacitor	22uF	Murata	GRM31CB30J226KE18	
CITH1	Ceramic capacitor	330pF	Murata	CRM18 Serie	
RITH1	Resistance	56kΩ	Rohm	MCR03 Serie	
CITH2	Ceramic capacitor	VOUT=1.0V	330pF	Murata	CRM18 Serie
		VOUT=1.2V	330pF	Murata	GRM18 Serie
		VOUT=1.5V	330pF	Murata	GRM18 Serie
		VOUT=1.8V	330pF	Murata	GRM18 Serie
		VOUT=2.5V	330pF	Murata	GRM18 Serie
RITH2	Resistance	VOUT=1.0V	39kΩ	Rohm	MCR03 Serie
		VOUT=1.2V	47kΩ	Rohm	MCR03 Serie
		VOUT=1.5V	56kΩ	Rohm	MCR03 Serie
		VOUT=1.8V	75kΩ	Rohm	MCR03 Serie
		VOUT=2.5V	91kΩ	Rohm	MCR03 Serie

※The parts list presented above is an example of recommended parts. Although the parts are sound, actual circuit characteristics should be checked on your application carefully before use. Be sure to allow sufficient margins to accommodate variations between external devices and this IC when employing the depicted circuit with other circuit constants modified. Both static and transient characteristics should be considered in establishing these margins. When switching noise is substantial and may impact the system, a low pass filter should be inserted between the VCC and PVCC pins, and a schottky barrier diode or snubber established between the SW and PGND pins.

● I/O equivalence circuit
【BD9150MUV】

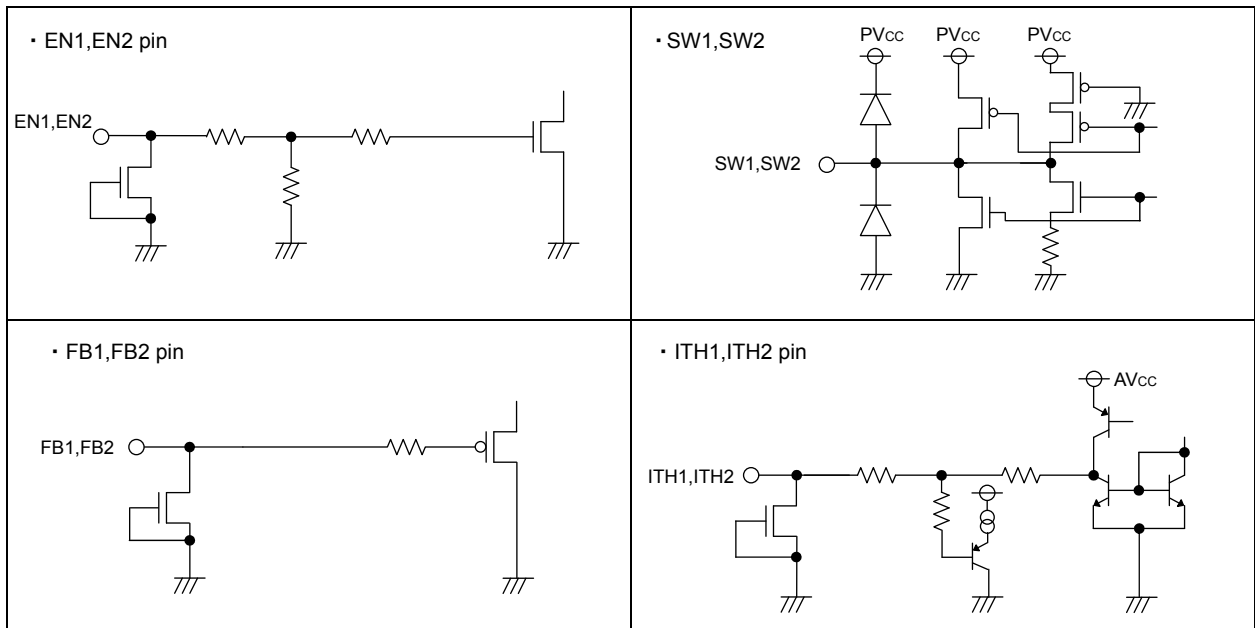

Fig.41 I/O equivalence circuit

●Notes for use

1. Absolute Maximum Ratings

While utmost care is taken to quality control of this product, any application that may exceed some of the absolute maximum ratings including the voltage applied and the operating temperature range may result in breakage. If broken, short-mode or open-mode may not be identified. So if it is expected to encounter with special mode that may exceed the absolute maximum ratings, it is requested to take necessary safety measures physically including insertion of fuses.

2. Electrical potential at GND

GND must be designed to have the lowest electrical potential In any operating conditions.

3. Short-circuiting between terminals, and mismounting

When mounting to pc board, care must be taken to avoid mistake in its orientation and alignment. Failure to do so may result in IC breakdown. Short-circuiting due to foreign matters entered between output terminals, or between output and power supply or GND may also cause breakdown.

4. Thermal shutdown protection circuit

Thermal shutdown protection circuit is the circuit designed to isolate the IC from thermal runaway, and not intended to protect and guarantee the IC. So, the IC the thermal shutdown protection circuit of which is once activated should not be used thereafter for any operation originally intended.

5. Inspection with the IC set to a pc board

If a capacitor must be connected to the pin of lower impedance during inspection with the IC set to a pc board, the capacitor must be discharged after each process to avoid stress to the IC. For electrostatic protection, provide proper grounding to assembling processes with special care taken in handling and storage. When connecting to jigs in the inspection process, be sure to turn OFF the power supply before it is connected and removed.

6. Input to IC terminals

This is a monolithic IC with P⁺ isolation between P-substrate and each element as illustrated below. This P-layer and the N-layer of each element form a P-N junction, and various parasitic element are formed.

If a resistor is joined to a transistor terminal as shown in Fig 42.

OP-N junction works as a parasitic diode if the following relationship is satisfied; GND>Terminal A (at resistor side), or GND>Terminal B (at transistor side); and

Oif GND>Terminal B (at NPN transistor side),

a parasitic NPN transistor is activated by N-layer of other element adjacent to the above-mentioned parasitic diode.

The structure of the IC inevitably forms parasitic elements, the activation of which may cause interference among circuits, and/or malfunctions contributing to breakdown. It is therefore requested to take care not to use the device in such manner that the voltage lower than GND (at P-substrate) may be applied to the input terminal, which may result in activation of parasitic elements.

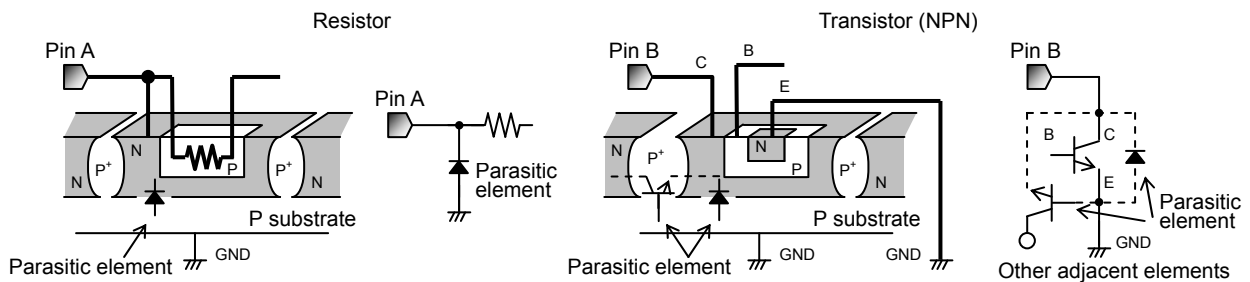

Fig.42 Simplified structure of monoristic IC

7. Ground wiring pattern

If small-signal GND and large-current GND are provided, It will be recommended to separate the large-current GND pattern from the small-signal GND pattern and establish a single ground at the reference point of the set PCB so that resistance to the wiring pattern and voltage fluctuations due to a large current will cause no fluctuations in voltages of the small-signal GND. Pay attention not to cause fluctuations in the GND wiring pattern of external parts as well.

8. Selection of inductor

It is recommended to use an inductor with a series resistance element (DCR) 0.1Ω or less. Especially, in case output voltage is set 1.6V or more, note that use of a high DCR inductor will cause an inductor loss, resulting in decreased output voltage. Should this condition continue for a specified period (soft start time + timer latch time), output short circuit protection will be activated and output will be latched OFF. When using an inductor over 0.1Ω, be careful to ensure adequate margins for variation between external devices and this IC, including transient as well as static characteristics. Furthermore, in any case, it is recommended to start up the output with EN after supply voltage is within operation range.

●Ordering part number

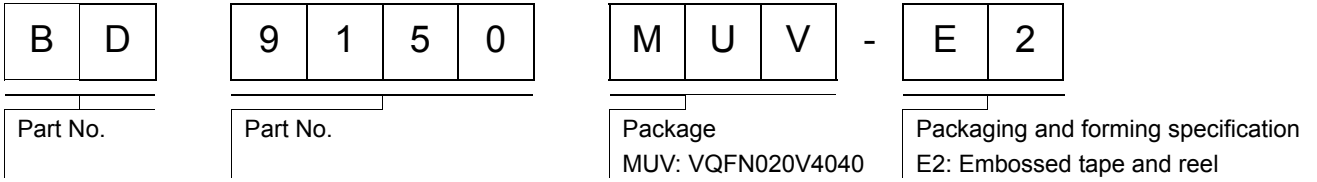

VQFN020V4040

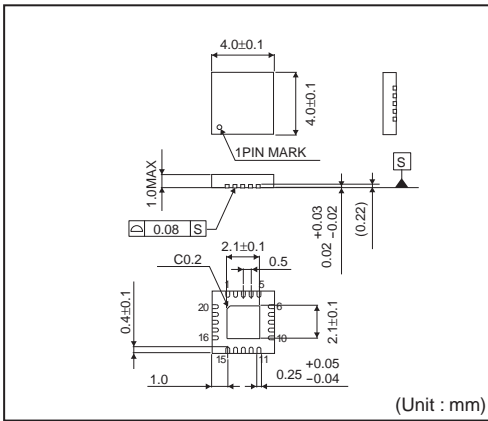

<Tape and Reel information>

Tape	Embossed carrier tape
Quantity	2500pcs
Direction of feed	E2 (The direction is the 1pin of product is at the upper left when you hold reel on the left hand and you pull out the tape on the right hand)

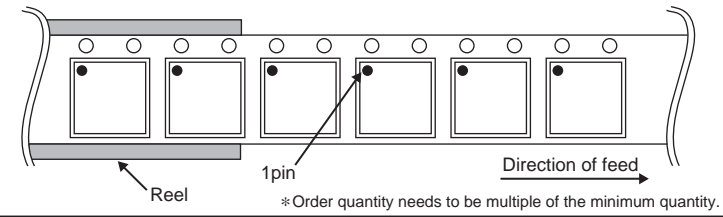

Notes

No copying or reproduction of this document, in part or in whole, is permitted without the consent of ROHM Co.,Ltd.

The content specified herein is subject to change for improvement without notice.

The content specified herein is for the purpose of introducing ROHM's products (hereinafter "Products"). If you wish to use any such Product, please be sure to refer to the specifications, which can be obtained from ROHM upon request.

Examples of application circuits, circuit constants and any other information contained herein illustrate the standard usage and operations of the Products. The peripheral conditions must be taken into account when designing circuits for mass production.

Great care was taken in ensuring the accuracy of the information specified in this document. However, should you incur any damage arising from any inaccuracy or misprint of such information, ROHM shall bear no responsibility for such damage.

The technical information specified herein is intended only to show the typical functions of and examples of application circuits for the Products. ROHM does not grant you, explicitly or implicitly, any license to use or exercise intellectual property or other rights held by ROHM and other parties. ROHM shall bear no responsibility whatsoever for any dispute arising from the use of such technical information.

The Products specified in this document are intended to be used with general-use electronic equipment or devices (such as audio visual equipment, office-automation equipment, communication devices, electronic appliances and amusement devices).

The Products specified in this document are not designed to be radiation tolerant.

While ROHM always makes efforts to enhance the quality and reliability of its Products, a Product may fail or malfunction for a variety of reasons.

Please be sure to implement in your equipment using the Products safety measures to guard against the possibility of physical injury, fire or any other damage caused in the event of the failure of any Product, such as derating, redundancy, fire control and fail-safe designs. ROHM shall bear no responsibility whatsoever for your use of any Product outside of the prescribed scope or not in accordance with the instruction manual.

The Products are not designed or manufactured to be used with any equipment, device or system which requires an extremely high level of reliability the failure or malfunction of which may result in a direct threat to human life or create a risk of human injury (such as a medical instrument, transportation equipment, aerospace machinery, nuclear-reactor controller, fuel-controller or other safety device). ROHM shall bear no responsibility in any way for use of any of the Products for the above special purposes. If a Product is intended to be used for any such special purpose, please contact a ROHM sales representative before purchasing.

If you intend to export or ship overseas any Product or technology specified herein that may be controlled under the Foreign Exchange and the Foreign Trade Law, you will be required to obtain a license or permit under the Law.



Thank you for your accessing to ROHM product informations.
More detail product informations and catalogs are available, please contact us.

ROHM Customer Support System

<http://www.rohm.com/contact/>