

N-Channel Power MOSFET

10A, 600V, 0.75Ω

GENERAL DESCRIPTION

The N-Channel MOSFET is used an advanced termination scheme to provide enhanced voltage-blocking capability without degrading performance over time. This advanced technology has been especially tailored to minimize on-state resistance, provide superior switching performance. This device is well suited for high efficiency switched mode power suppliers, active power factor correction, electronic lamp ballasts based half bridge topology.

FEATURES

- Robust high voltage termination
- Avalanche energy specified
- Diode is characterized for use in bridge circuits
- Source to Drain diode recovery time comparable to a discrete fast recovery diode.

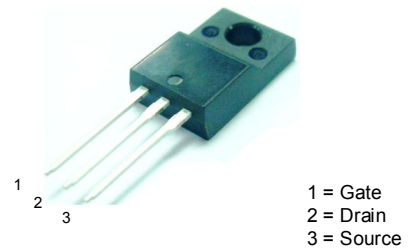

TO-220FP

DEVICE MARKING DIAGRAM

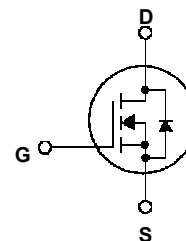

ABSOLUTE MAXIMUM RATINGS (T_C=25°C, unless otherwise noted)

Symbol	Parameter	Value	Units
V _{DSS}	Drain- Source Voltage	600	V
V _{GSS}	Gate-Source Voltage	±20	V
I _D	Drain Current	10	A
	Continuous Drain Current T _c =100°C	6.4	A
I _{DM}	Drain Current Pulsed	40	A
P _D	Power Dissipation (Note 2)	45	W
	Derating Factor above 25°C	0.36	W/°C
E _{AS}	Single Pulsed Avalanche Energy (Note 1)	300	mJ
E _{AR}	Repetitive Avalanche Energy (Note 2)	30	mJ
T _J	Operating Junction Temperature	150	°C
T _{stg}	Storage Temperature Range	- 55 to +150	°C

Notes:

1. L=10mH, I_{AS}=8.0A, V_{DD}=50V, R_G=50Ω, Starting T_J=25°C
2. Repetitive Rating: Pulse width limited by maximum junction temperature.

THERMAL CHARACTERISTICS

Symbol	Parameter	Value	Unit
R _{θJC}	Thermal Resistance, Junction-to-Case	2.78	°C/W
R _{θJA}	Thermal Resistance, Junction-to-Ambient	62	°C/W

ELECTRICAL CHARACTERISTICS
Off Characteristics ($T_A = 25^\circ\text{C}$ unless otherwise noted)

Symbol	Parameter	Test Conditions	Min.	Typ.	Max.	Unit
BV_{DSS}	Drain-Source Breakdown Voltage	$V_{GS} = 0V, I_D = 250\mu A$	600	--	--	V
I_{DSS}	Zero Gate Voltage Drain Current	$V_{DS} = 600V, V_{GS} = 0V$	--	--	25	μA
I_{GSSF}	Gate-Body Leakage Current, Forward	$V_{GS} = 20V, V_{DS} = 0V$	--	--	10	μA
I_{GSSR}	Gate-Body Leakage Current, Reverse	$V_{GS} = -20V, V_{DS} = 0V$	--	--	-10	μA

On Characteristics ($T_A = 25^\circ\text{C}$ unless otherwise noted)

Symbol	Parameter	Test Conditions	Min.	Typ.	Max.	Unit
$V_{GS(th)}$	Gate Threshold Voltage	$V_{DS} = V_{GS}, I_D = 250\mu A$	2.0	--	4.0	V
$R_{DS(ON)}$	On-Resistance	$V_{GS} = 10V, I_D = 5A$	--	0.63	0.75	Ω

Dynamic Characteristics

Symbol	Parameter	Test Conditions	Min.	Typ.	Max.	Unit
C_{iss}	Input Capacitance	$V_{DS} = 25V, V_{GS} = 0V,$ $f = 1.0\text{MHz}$	--	1430	--	pF
C_{oss}	Output Capacitance		--	160	--	pF
C_{rss}	Reverse Transfer Capacitance		--	28	--	pF

Switching Characteristics

Symbol	Parameter	Test Conditions	Min.	Typ.	Max.	Unit
$t_{d(on)}$	Turn-On Delay Time	$V_{DD} = 300V, I_D = 10A,$ $V_{GS} = 10V, R_G = 4.7\Omega$ (Note 3 & 4)	--	20	--	nS
t_r	Turn-On Rise Time		--	20	--	nS
$t_{d(off)}$	Turn-Off Delay Time		--	55	--	nS
t_f	Turn-Off Fall Time		--	30	--	nS
Q_g	Total Gate Charge	$V_{DS} = 480V, I_D = 10A,$	--	60	70	nC
Q_{gs}	Gate-Source Charge	$V_{GS} = 10V$	--	12	--	nC
Q_{gd}	Gate-Drain Charge	(Note 3 & 4)	--	28	--	nC

Drain-Source Diode Characteristics and Maximum Ratings

Symbol	Parameter	Test Conditions	Min.	Typ.	Max.	Unit
I_S	Maximum Continuous Drain-Source Diode Forward Current		--	--	10	A
I_{SM}	Maximum Pulsed Drain-Source Diode Forward Current		--	--	40	A
V_{SD}	Drain-Source Diode Forward Voltage	$V_{GS} = 0V, I_S = 10A$	--	--	1.5	V
T_{rr}	Reverse Recovery Time	$V_{GS} = 0V, I_S = 10A,$ $dI_F / dt = 100A/\mu S$ (Note 3)	--	600	--	nS
Q_{rr}	Reverse Recovery Charge		--	4.3	--	nC
I_{RRM}	Reverse Recovery Current		--	13	--	A

Notes:

- Pulse Test: Pulse width < 380 μs , Duty cycle $\leq 2\%$.
- Basically not affected by working temperature.

TYPICAL CHARACTERISTICS

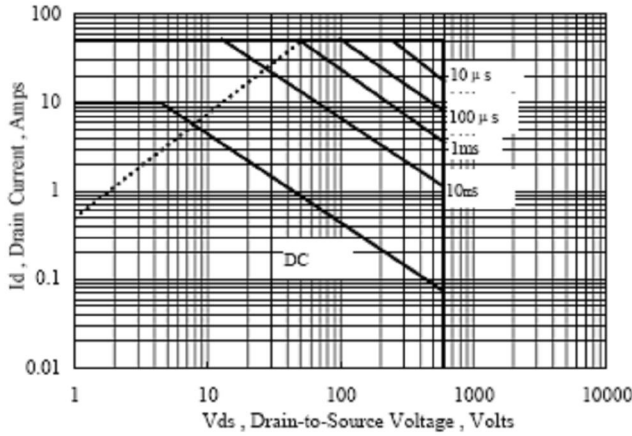

Figure 1 Maximum Forward Bias Safe Operating Area

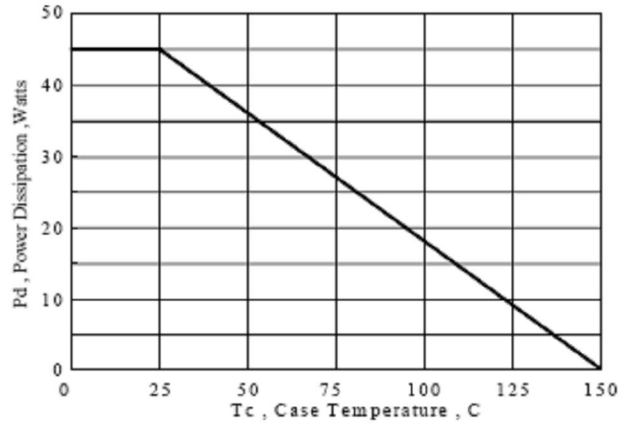

Figure 2 Maximum Power Dissipation vs Case Temperature

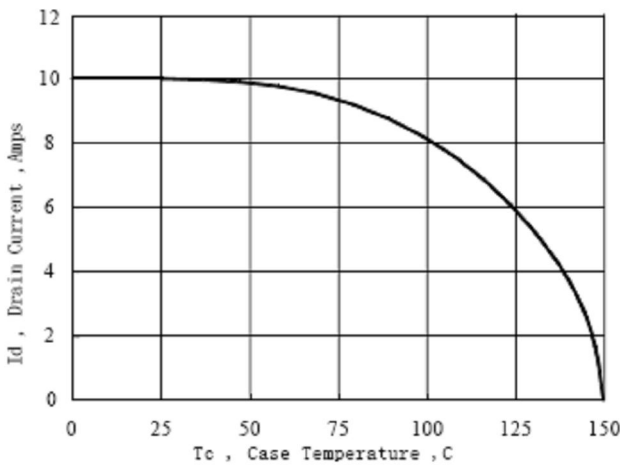

Figure 3 Maximum Continuous Drain Current vs Case Temperature

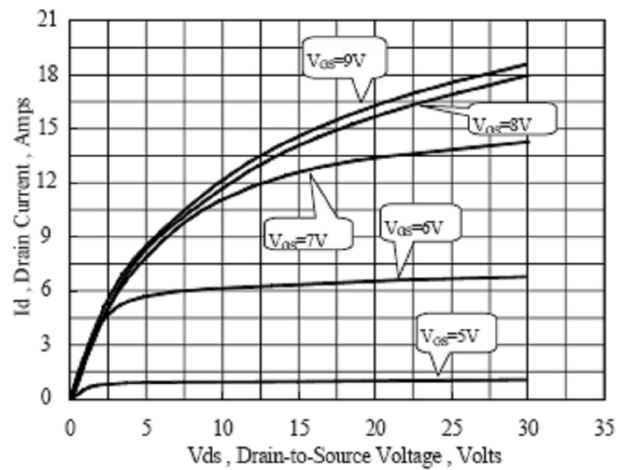

Figure 4 Typical Output Characteristics

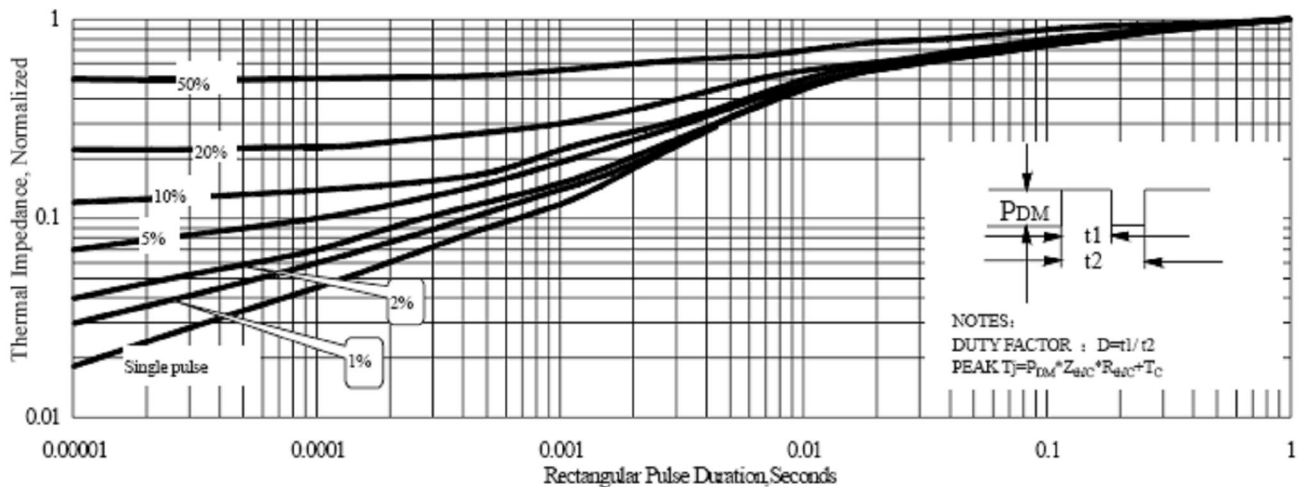
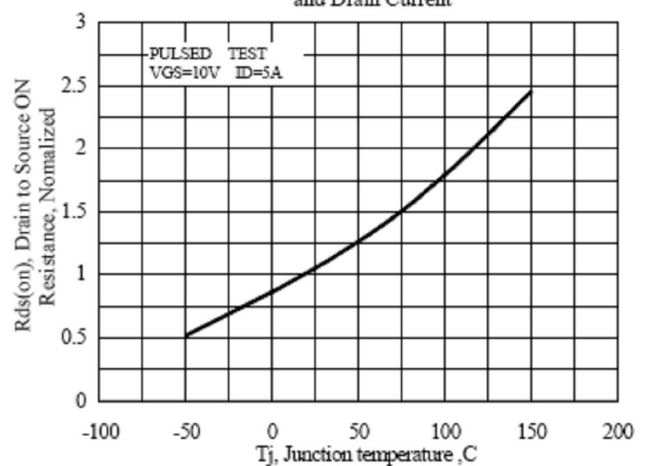
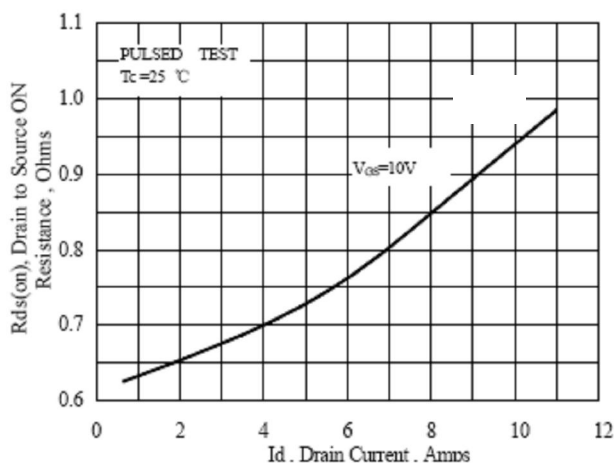
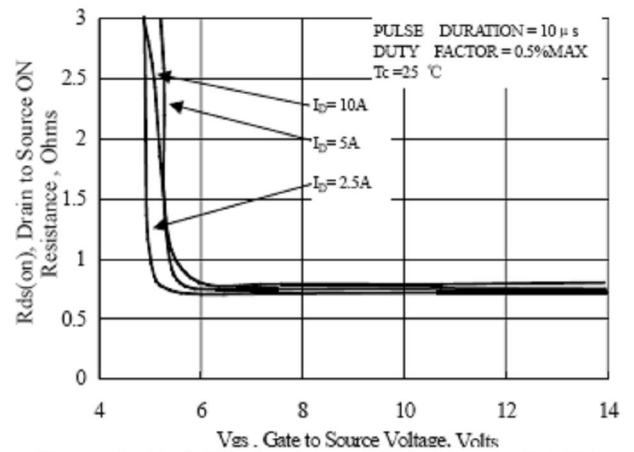
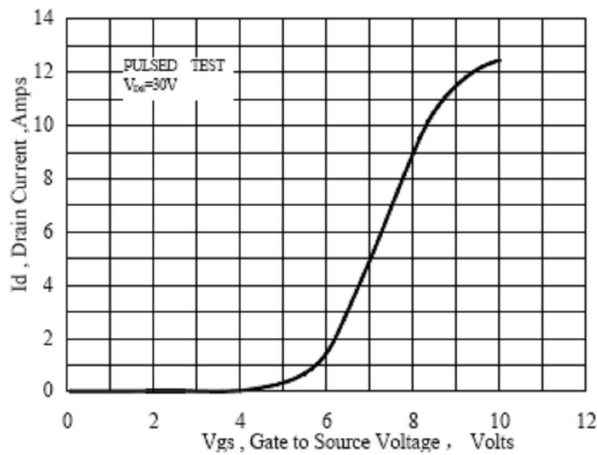
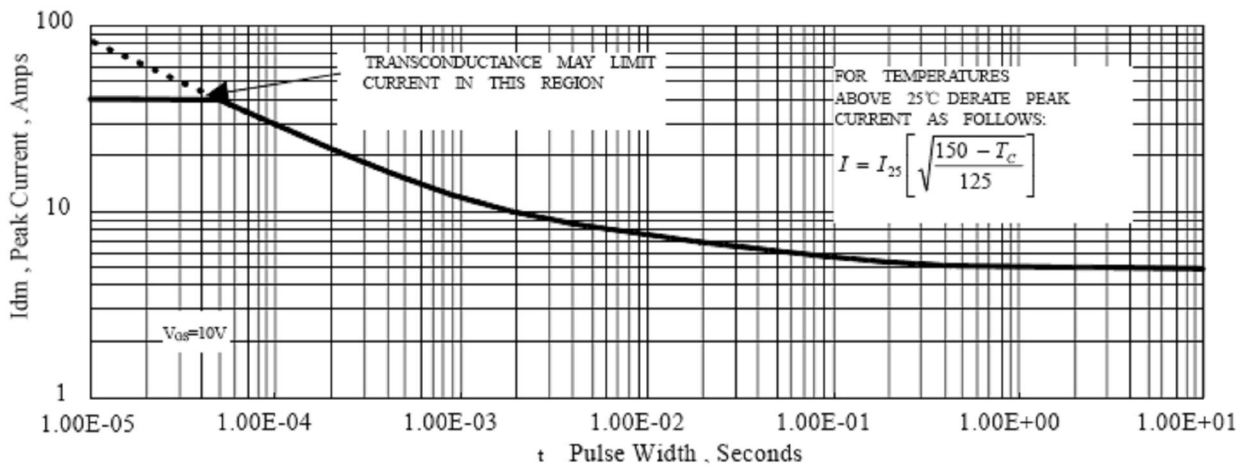
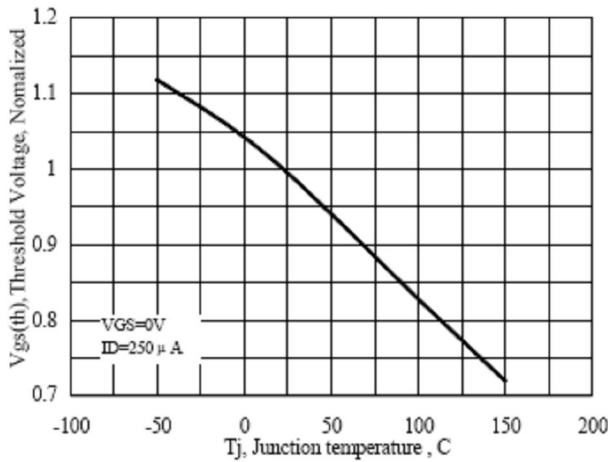
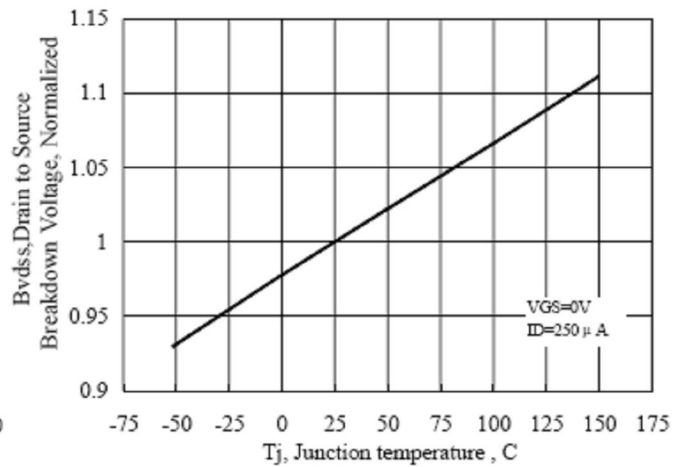
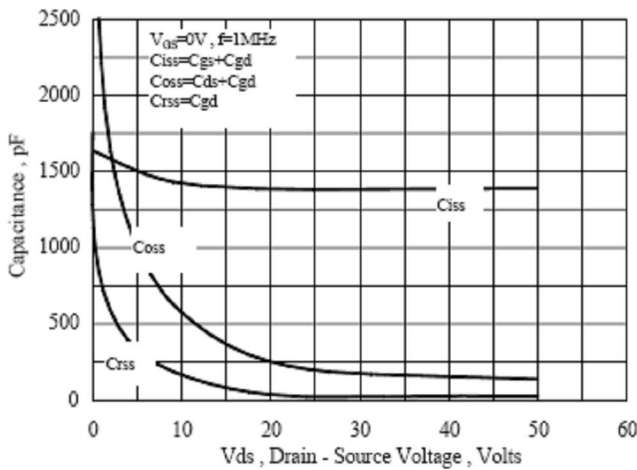
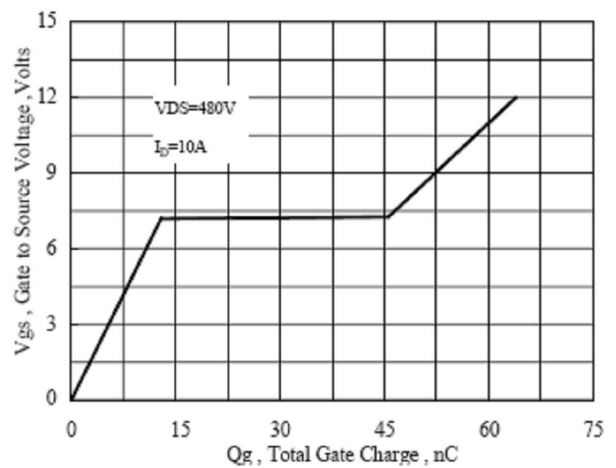
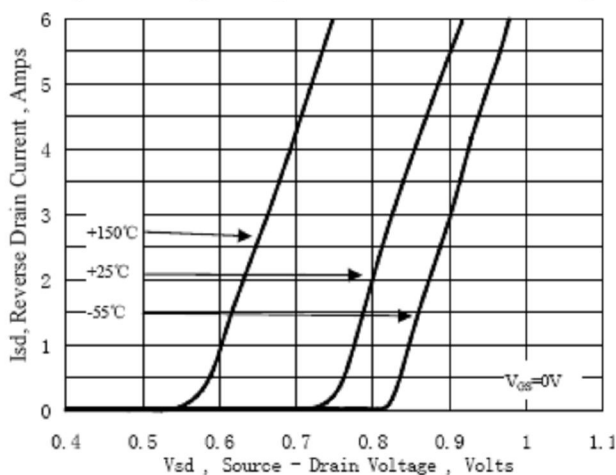
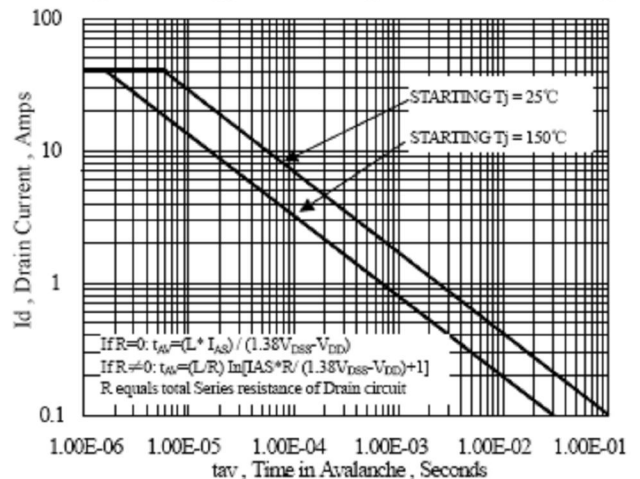
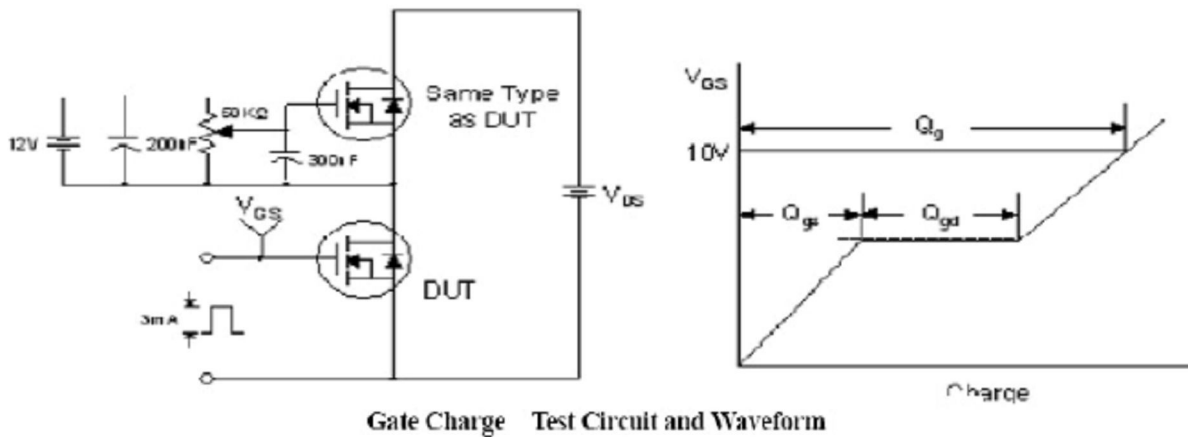
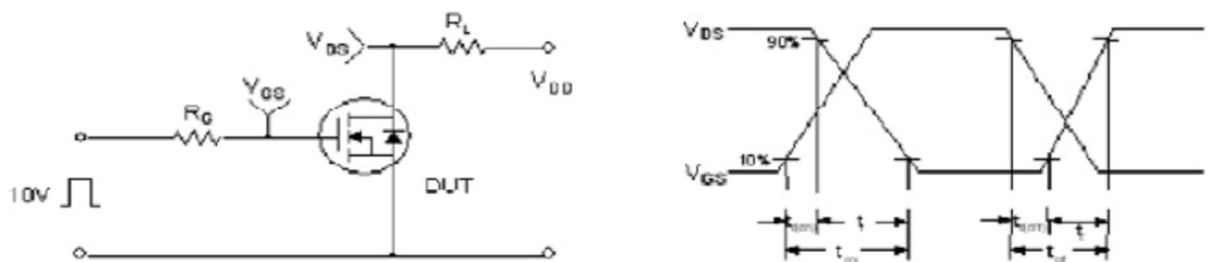
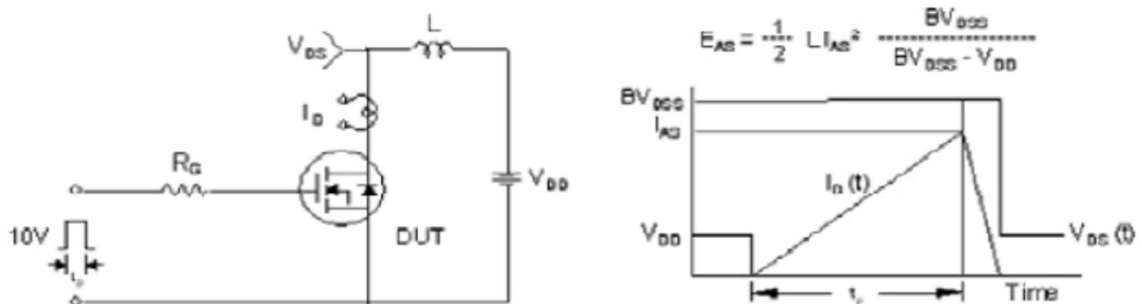

Figure 5 Maximum Effective Thermal Impedance, Junction to Case



Figure 11 Typical Threshold Voltage vs Junction Temperature

Figure 12 Typical Breakdown Voltage vs Junction Temperature

Figure 13 Typical Capacitance vs Drain to Source Voltage

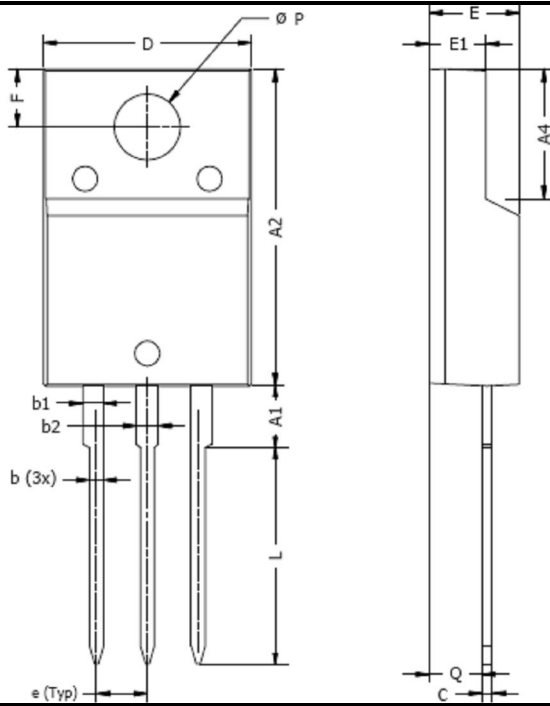
Figure 14 Typical Gate Charge vs Gate to Source Voltage

Figure 15 Typical Body Diode Transfer Characteristics

Figure 16 Unclamped Inductive Switching Capability

TEST CIRCUIT AND WAVEFORM

Gate Charge Test Circuit and Waveform

Resistive Switching Test Circuit and Waveform

Unclamped Inductive Switching Test Circuit and Waveform

TO220AB PACKAGE OUTLINE



DIM	MILLIMETERS		INCHES	
	MIN	MAX	MIN	MAX
A1	2.7	3.3	0.106	0.130
A2	15.0	15.7	0.591	0.618
A4	6.2	6.6	0.244	0.260
b	0.5	0.9	0.020	0.035
b1	0.9	1.2	0.035	0.047
b2	1.0	1.2	0.039	0.047
c	0.4	0.6	0.016	0.024
D	9.8	10.3	0.386	0.406
e	2.34	2.74	0.092	0.108
E	4.3	4.6	0.169	0.181
E1	2.5	2.9	0.098	0.114
F	2.6	3.0	0.102	0.118
L	10.3	10.7	0.406	0.421
ØP	3.0	3.4	0.118	0.134
Q	2.3	2.7	0.091	0.106

Note: Single Gauge

NOTICE

The information presented in this document is for reference only. Tak Cheong reserves the right to make changes without notice for the specification of the products displayed herein.

The product listed herein is designed to be used with ordinary electronic equipment or devices, and not designed to be used with equipment or devices which require high level of reliability and the malfunction of which would directly endanger human life (such as medical instruments, transportation equipment, aerospace machinery, nuclear-reactor controllers, fuel controllers and other safety devices), Tak Cheong Semiconductor Co., Ltd., or anyone on its behalf, assumes no responsibility or liability for any damages resulting from such improper use of sale.

This publication supersedes & replaces all information previously supplied. For additional information, please visit our website <http://www.takcheong.com>, or consult your nearest Tak Cheong's sales office for further assistance.