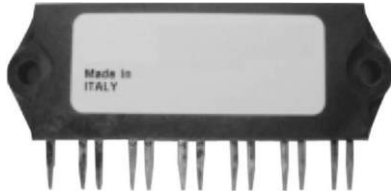

## IGBT SIP Module (Fast IGBT)

**IMS-2**

### FEATURES

- Fully isolated printed circuit board mount package
- Switching-loss rating includes all “tail” losses
- HEXFRED® soft ultrafast diodes
- Optimized for high speed over 5 kHz  
See fig. 1 for current vs. frequency curve
- Totally lead (Pb)-free
- Designed and qualified for industrial level

**RoHS  
COMPLIANT**

### PRODUCT SUMMARY

#### OUTPUT CURRENT IN A TYPICAL 20 kHz MOTOR DRIVE

$I_{RMS}$ per phase (3.1 kW total) with $T_C = 90\text{ }^\circ\text{C}$	4.6 $A_{RMS}$
$T_J$	125 $^\circ\text{C}$
Supply voltage	360 Vdc
Power factor	0.8
Modulation depth (see fig. 1)	115 %
$V_{CE(on)}$ (typical) at $I_C = 3.9\text{ A}$ , 25 $^\circ\text{C}$	1.7 V

### DESCRIPTION

The IGBT technology is the key to Vishay’s HPP advanced line of IMS (Insulated Metal Substrate) power modules. These modules are more efficient than comparable bipolar transistor modules, while at the same time having the simpler gate-drive requirements of the familiar power MOSFET. This superior technology has now been coupled to a state of the art materials system that maximizes power throughput with low thermal resistance. This package is highly suited to motor drive applications and where space is at a premium.

### ABSOLUTE MAXIMUM RATINGS

PARAMETER	SYMBOL	TEST CONDITIONS	MAX.	UNITS
Collector to emitter voltage	$V_{CES}$		600	V
Continuous collector current, each IGBT	$I_C$	$T_C = 25\text{ }^\circ\text{C}$	7.2	A
		$T_C = 100\text{ }^\circ\text{C}$	3.9	
Pulsed collector current	$I_{CM}^{(1)}$		22	
Clamped inductive load current	$I_{LM}^{(2)}$			
Diode continuous forward current	$I_F$	$T_C = 100\text{ }^\circ\text{C}$	3.4	
Diode maximum forward current	$I_{FM}$		22	
Gate to emitter voltage	$V_{GE}$		$\pm 20$	V
Isolation voltage	$V_{ISOL}$	1 minute, any terminal to case	2500	$V_{RMS}$
Maximum power dissipation, each IGBT	$P_D$	$T_C = 25\text{ }^\circ\text{C}$	23	W
		$T_C = 100\text{ }^\circ\text{C}$	9.1	
Operating junction and storage temperature range	$T_J, T_{Stg}$		- 40 to + 150	$^\circ\text{C}$
Soldering temperature		10 s, (0.063" (1.6 mm) from case)	300	
Mounting torque		6-32 or M3 screw	5 to 7 (0.55 to 0.8)	

#### Notes

(1) Repetitive rating;  $V_{GE} = 20\text{ V}$ , pulse width limited by maximum junction temperature (see fig. 20)

(2)  $V_{CC} = 80\% (V_{GES})$ ,  $V_{GE} = 20\text{ V}$ ,  $L = 10\text{ }\mu\text{H}$ ,  $R_G = 50\text{ }\Omega$  (see fig. 19)



THERMAL AND MECHANICAL SPECIFICATIONS				
PARAMETER	SYMBOL	TYP.	MAX.	UNITS
Junction to case, each IGBT, one IGBT in conduction	$R_{thJC}$ (IGBT)	-	5.5	°C/W
Junction to case, each DIODE, one DIODE on conduction	$R_{thJC}$ (DIODE)	-	9.0	
Case to sink, flat, greased surface	$R_{thCS}$ (MODULE)	0.1	-	
Weight of module		20		g
		0.7		oz.

ELECTRICAL SPECIFICATIONS ( $T_J = 25\text{ °C}$ unless otherwise noted)							
PARAMETER	SYMBOL	TEST CONDITIONS	MIN.	TYP.	MAX.	UNITS	
Collector to emitter breakdown voltage	$V_{(VB)CES}^{(1)}$	$V_{GE} = 0\text{ V}, I_C = 250\text{ }\mu\text{A}$	600	-	-	V	
Temperature coefficient of breakdown voltage	$\Delta V_{(BR)CES}/\Delta T_J$	$V_{GE} = 0\text{ V}, I_C = 1\text{ mA}$	-	0.63	-	V/°C	
Collector to emitter saturation voltage	$V_{CE(on)}$	$I_C = 3.9\text{ A}$	$V_{GE} = 15\text{ V}$ See fig. 2, 5	-	1.70	2.2	V
		$I_C = 7.2\text{ A}$		-	1.95	-	
		$I_C = 3.9\text{ A}, T_J = 150\text{ °C}$		-	1.70	-	
Gate threshold voltage	$V_{GE(th)}$	$V_{CE} = V_{GE}, I_C = 250\text{ }\mu\text{A}$	3.0	-	6.0	mV/°C	
Temperature coefficient of threshold voltage	$\Delta V_{GE(th)}/\Delta T_J$		-	-11	-		
Forward transconductance	$g_{fe}^{(2)}$	$V_{CE} = 100\text{ V}, I_C = 6.5\text{ A}$	1.4	4.3	-	S	
Zero gate voltage collector current	$I_{CES}$	$V_{GE} = 0\text{ V}, V_{CE} = 600\text{ V}$	-	-	250	$\mu\text{A}$	
		$V_{GE} = 0\text{ V}, V_{CE} = 600\text{ V}, T_J = 150\text{ °C}$	-	-	2500		
Diode forward voltage drop	$V_{FM}$	$I_C = 8.0\text{ A}$	See fig. 13	-	1.4	1.7	V
		$I_C = 8.0\text{ A}, T_J = 150\text{ °C}$		-	1.3	1.6	
Gate to emitter leakage current	$I_{GES}$	$V_{GE} = \pm 20\text{ V}$	-	-	$\pm 100$	nA	

**Notes**

- (1) Pulse width  $\leq 80\text{ }\mu\text{s}$ ; duty factor  $\leq 0.1\%$
- (2) Pulse width  $5.0\text{ }\mu\text{s}$ , single shot



SWITCHING CHARACTERISTICS (T <sub>J</sub> = 25 °C unless otherwise specified)									
PARAMETER	SYMBOL	TEST CONDITIONS		MIN.	TYP.	MAX.	UNITS		
Total gate charge (turn-on)	O <sub>g</sub>	I <sub>C</sub> = 3.9 A V <sub>CC</sub> = 400 V V <sub>GE</sub> = 15 V		-	31	47	nC		
Gate to emitter charge (turn-on)	O <sub>GE</sub>			-	5.0	7.5			
Gate to collector charge (turn-on)	O <sub>gc</sub>			-	13	20			
Turn-on delay time	t <sub>d(on)</sub>	T <sub>J</sub> = 25 °C I <sub>C</sub> = 3.9 A, V <sub>CC</sub> = 480 V V <sub>GE</sub> = 15 V, R <sub>G</sub> = 50 Ω Energy losses include "tail" and diode reverse recovery See fig. 9, 10, 11, 18		-	45	-	ns		
Rise time	t <sub>r</sub>			-	22	-			
Turn-off delay time	t <sub>d(off)</sub>			-	100	160			
Fall time	t <sub>f</sub>			-	120	180			
Turn-on switching loss	E <sub>on</sub>			-	0.13	-		mJ	
Turn-off switching loss	E <sub>off</sub>	-	0.07	-					
Total switching loss	E <sub>ts</sub>	-	0.20	0.3					
Turn-on delay time	t <sub>d(on)</sub>	T <sub>J</sub> = 150 °C I <sub>C</sub> = 3.9 A, V <sub>CC</sub> = 480 V V <sub>GE</sub> = 15 V, R <sub>G</sub> = 50 Ω Energy losses include "tail" and diode reverse recovery See fig. 9, 10, 11, 18		-	42	-	ns		
Rise time	t <sub>r</sub>			-	22	-			
Turn-off delay time	t <sub>d(off)</sub>			-	120	-			
Fall time	t <sub>f</sub>			-	250	-			
Total switching loss	E <sub>ts</sub>			-	0.35	-		mJ	
Input capacitance	C <sub>ies</sub>	V <sub>GE</sub> = 0 V V <sub>CC</sub> = 30 V f = 1.0 MHz		See fig. 7		-	530	-	pF
Output capacitance	C <sub>oes</sub>					-	39	-	
Reverse transfer capacitance	C <sub>res</sub>					-	7.4	-	
Diode reverse recovery time	t <sub>rr</sub>	T <sub>J</sub> = 25 °C	See fig. 14	-	37	55	ns		
		T <sub>J</sub> = 125 °C		-	55	90			
Diode peak reverse recovery current	I <sub>rr</sub>	T <sub>J</sub> = 25 °C	See fig. 15	-	3.5	5.0	A		
		T <sub>J</sub> = 125 °C		-	4.5	8.0			
Diode reverse recovery charge	Q <sub>rr</sub>	T <sub>J</sub> = 25 °C	See fig. 16	I <sub>F</sub> = 8.0 A V <sub>R</sub> = 200 V di/dt = 200 A/μs		-	65	138	nC
		T <sub>J</sub> = 125 °C				-	124	360	
Diode peak rate of fall of recovery during t <sub>b</sub>	dl <sub>(rec)</sub> /dt	T <sub>J</sub> = 25 °C	See fig. 17	-	240	-	A/μs		
		T <sub>J</sub> = 125 °C		-	210	-			

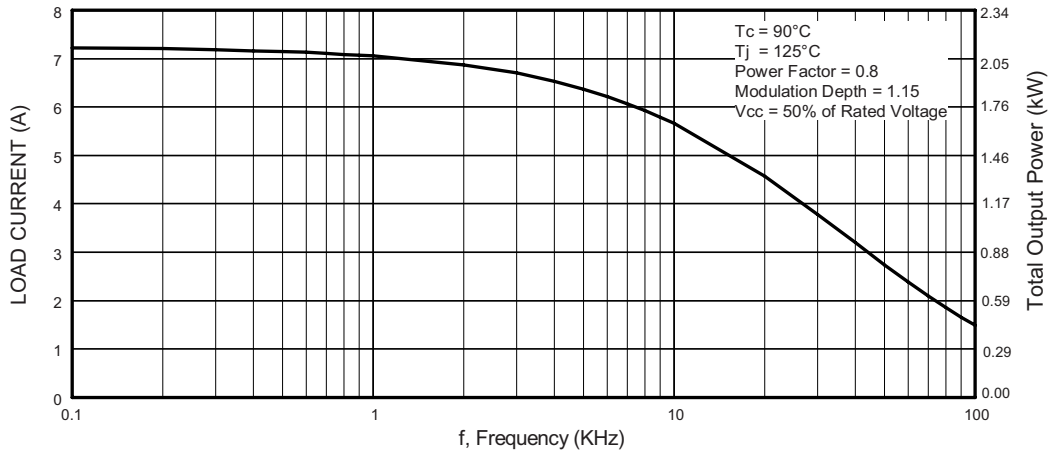

Fig. 1 - Typical Load Current vs. Frequency  
(Load Current =  $I_{RMS}$  of Fundamental)

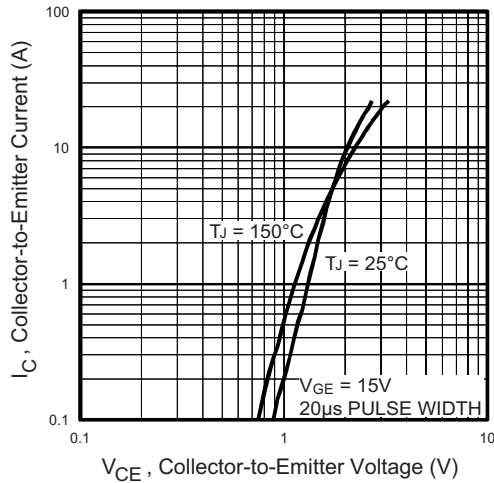

Fig. 2 - Typical Output Characteristics

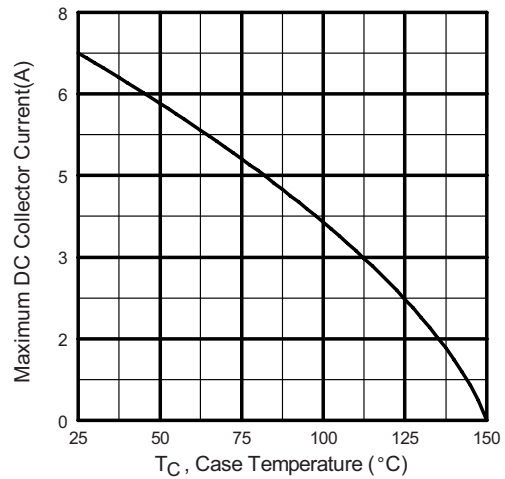

Fig. 4 - Maximum Collector Current vs. Case Temperature

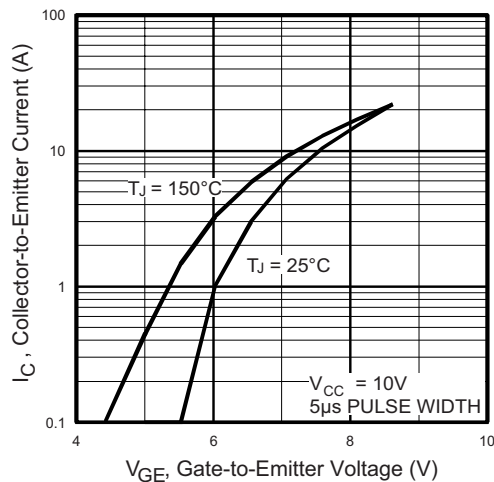

Fig. 3 - Typical Transfer Characteristics

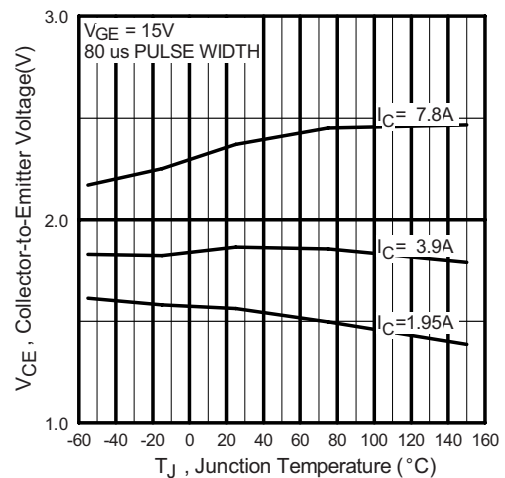

Fig. 5 - Typical Collector to Emitter Voltage vs. Junction Temperature

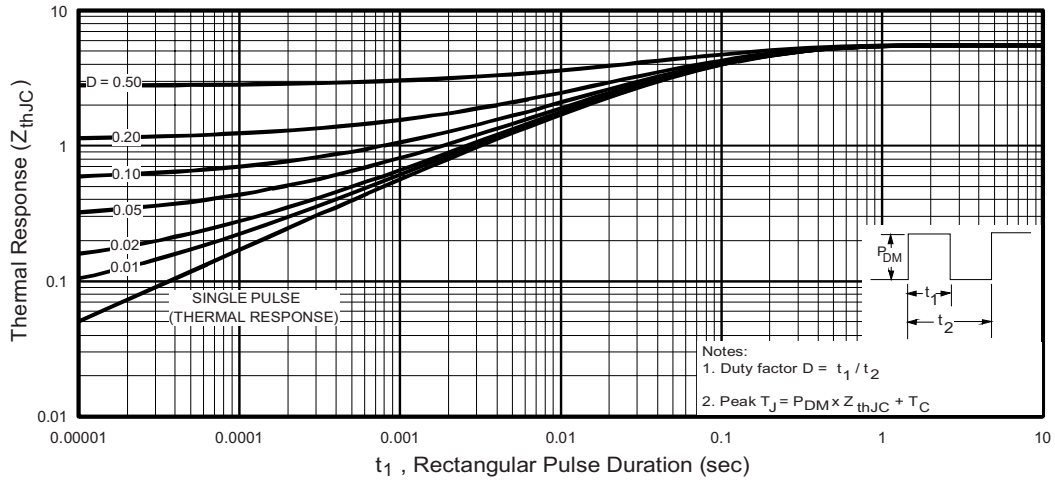

Fig. 6 - Maximum Effective Transient Thermal Impedance, Junction to Case

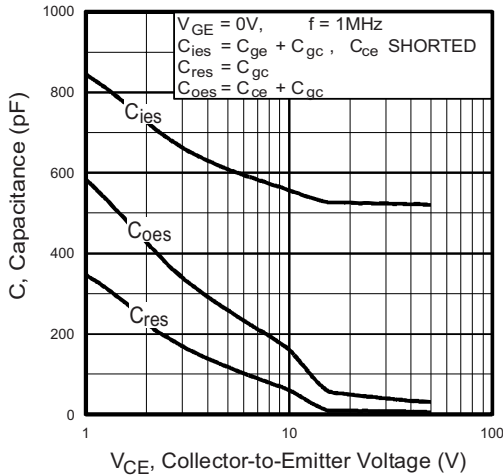

Fig. 7 - Typical Capacitance vs. Collector to Emitter Voltage

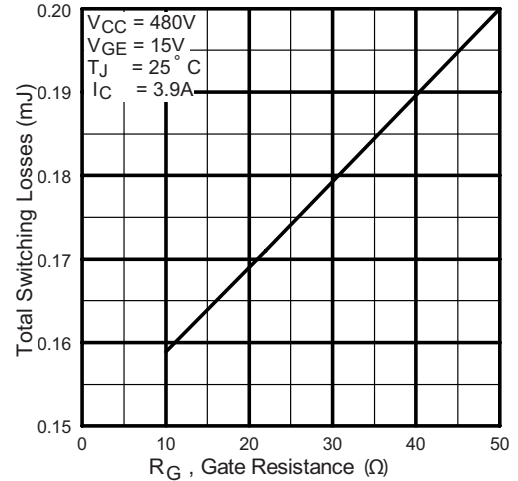

Fig. 9 - Typical Switching Losses vs. Gate Resistance

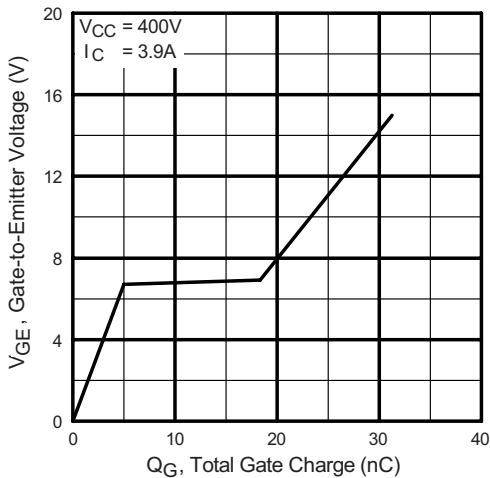

Fig. 8 - Typical Gate Charge vs. Gate to Emitter Voltage

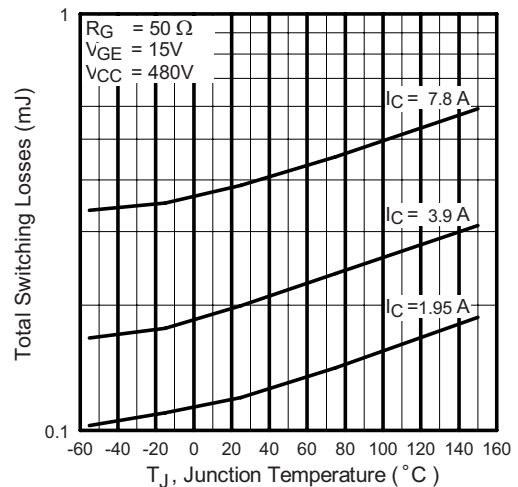

Fig. 10 - Typical Switching Losses vs. Junction Temperature

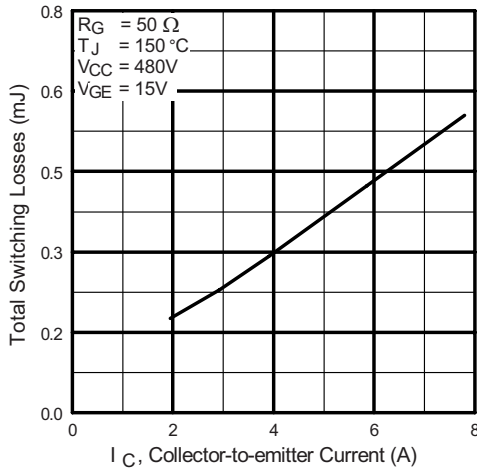

Fig. 11 - Typical Switching Losses vs. Collector to Emitter Current

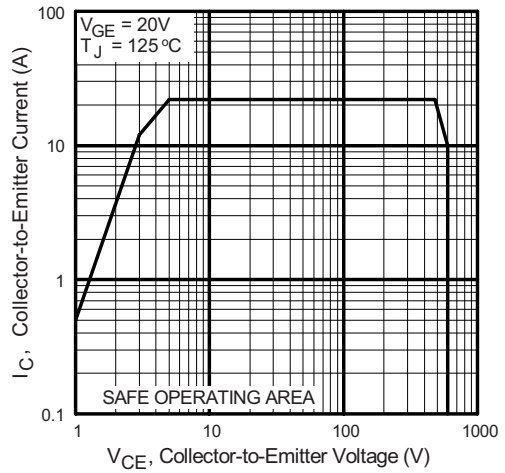

Fig. 12 - Turn-Off SOA

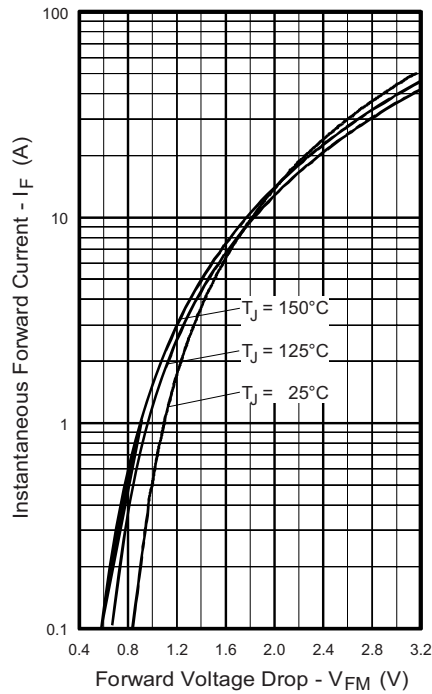

Fig. 13 - Maximum Forward Voltage Drop vs. Instantaneous Forward Current

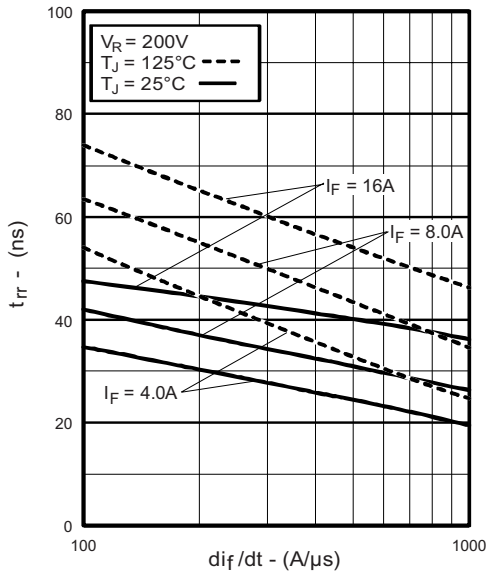

Fig. 14 - Typical Reverse Recovery Time vs.  $di_F/dt$

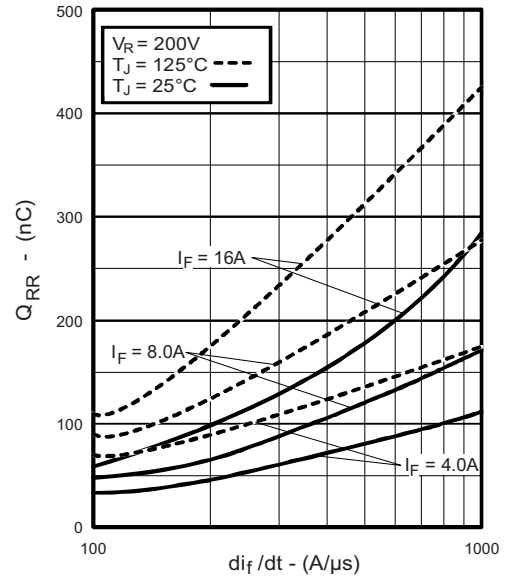

Fig. 16 - Typical Stored Charge vs.  $di_F/dt$

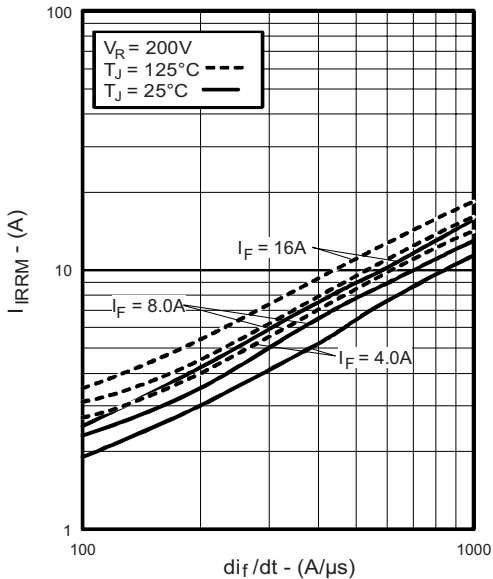

Fig. 15 - Typical Recovery Current vs.  $di_F/dt$

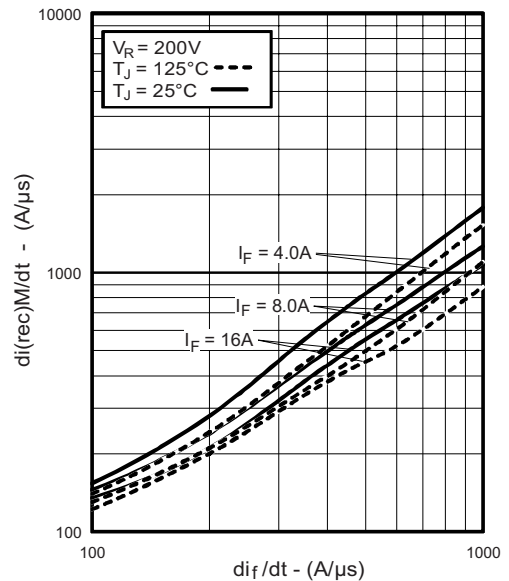

Fig. 17 - Typical  $di_{(rec)M}/dt$  vs.  $di_F/dt$

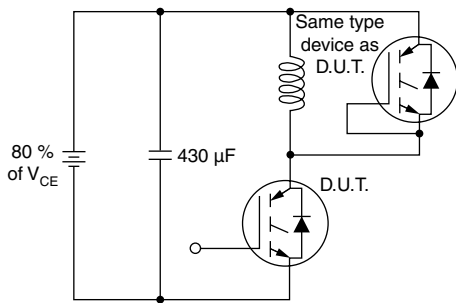

Fig. 18a - Test Circuit for Measurement of  $I_{LM}$ ,  $E_{on}$ ,  $E_{off}(\text{diode})$ ,  $t_{rr}$ ,  $Q_{rr}$ ,  $I_{rr}$ ,  $t_{d(on)}$ ,  $t_r$ ,  $t_{d(off)}$ ,  $t_f$

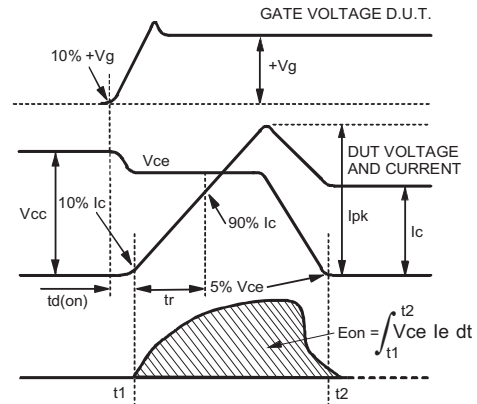

Fig. 18c - Test Waveforms for Circuit of Fig. 18a, Defining  $E_{on}$ ,  $t_{d(on)}$ ,  $t_r$

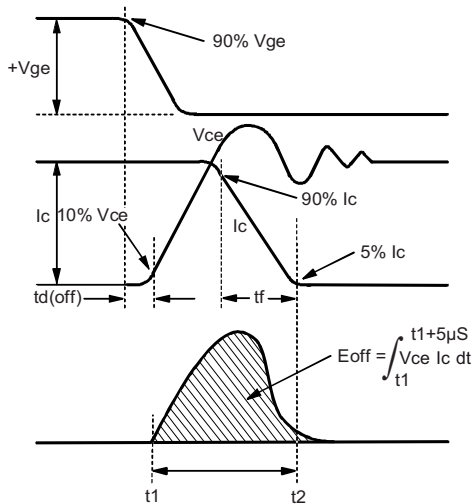

Fig. 18b - Test Waveforms for Circuit of Fig. 18a, Defining  $E_{off}$ ,  $t_{d(off)}$ ,  $t_f$

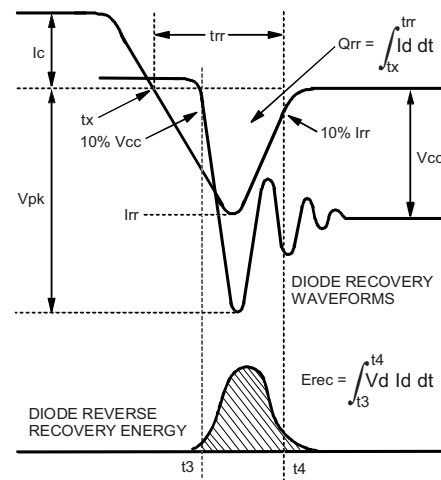

Fig. 18d - Test Waveforms for Circuit of Fig. 18a, Defining  $E_{rec}$ ,  $t_{rr}$ ,  $Q_{rr}$ ,  $I_{rr}$



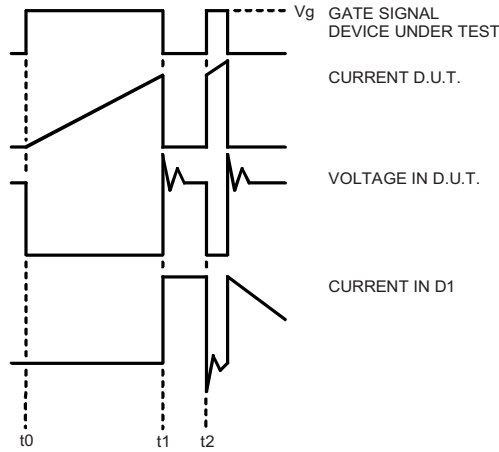

Fig. 18e - Macro Waveforms for Fig. 18a's Test Circuit

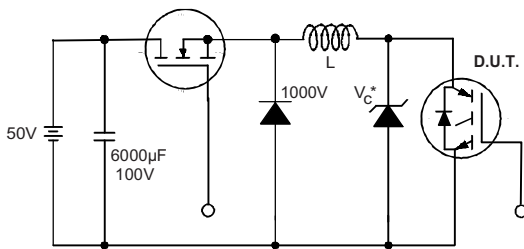

Fig. 19 - Clamped Inductive Load Test Circuit

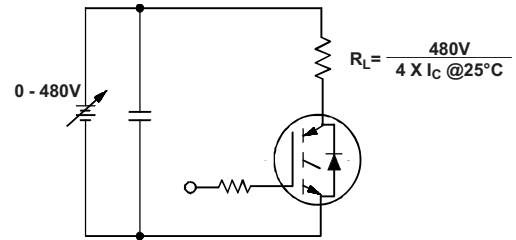
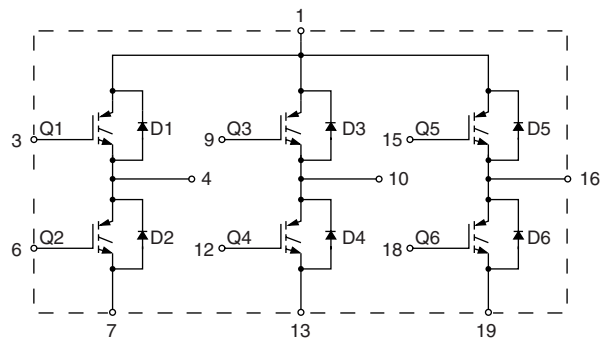

Fig. 20 - Pulsed Collector Current Test Circuit

**CIRCUIT CONFIGURATION**



LINKS TO RELATED DOCUMENTS	
Dimensions	<a href="http://www.vishay.com/doc?95066">http://www.vishay.com/doc?95066</a>

## IMS-2 (SIP)

**DIMENSIONS** in millimeters (inches)

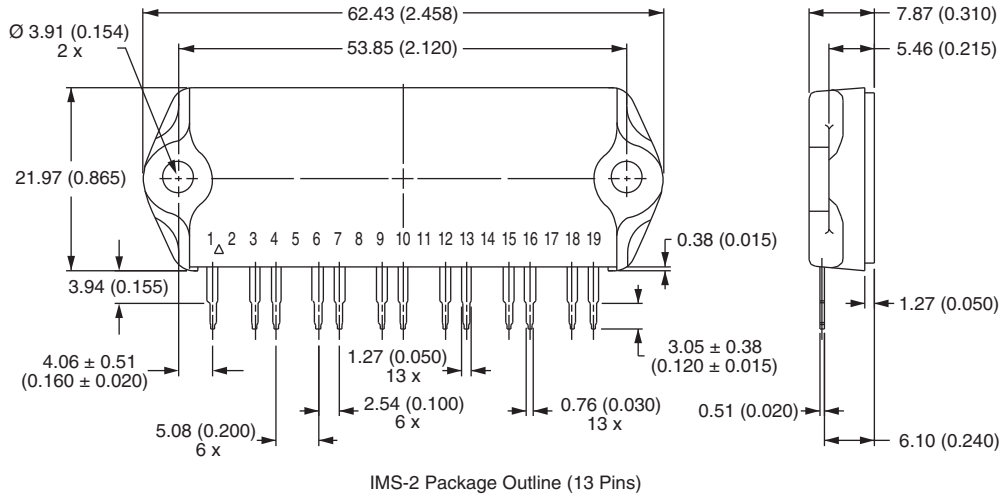

### Notes

- (1) Tolerance unless otherwise specified ± 0.254 mm (0.010")
- (2) Controlling dimension: inch
- (3) Terminal numbers are shown for reference only



## Disclaimer

ALL PRODUCT, PRODUCT SPECIFICATIONS AND DATA ARE SUBJECT TO CHANGE WITHOUT NOTICE TO IMPROVE RELIABILITY, FUNCTION OR DESIGN OR OTHERWISE.

Vishay Intertechnology, Inc., its affiliates, agents, and employees, and all persons acting on its or their behalf (collectively, "Vishay"), disclaim any and all liability for any errors, inaccuracies or incompleteness contained in any datasheet or in any other disclosure relating to any product.

Vishay makes no warranty, representation or guarantee regarding the suitability of the products for any particular purpose or the continuing production of any product. To the maximum extent permitted by applicable law, Vishay disclaims (i) any and all liability arising out of the application or use of any product, (ii) any and all liability, including without limitation special, consequential or incidental damages, and (iii) any and all implied warranties, including warranties of fitness for particular purpose, non-infringement and merchantability.

Statements regarding the suitability of products for certain types of applications are based on Vishay's knowledge of typical requirements that are often placed on Vishay products in generic applications. Such statements are not binding statements about the suitability of products for a particular application. It is the customer's responsibility to validate that a particular product with the properties described in the product specification is suitable for use in a particular application. Parameters provided in datasheets and/or specifications may vary in different applications and performance may vary over time. All operating parameters, including typical parameters, must be validated for each customer application by the customer's technical experts. Product specifications do not expand or otherwise modify Vishay's terms and conditions of purchase, including but not limited to the warranty expressed therein.

Except as expressly indicated in writing, Vishay products are not designed for use in medical, life-saving, or life-sustaining applications or for any other application in which the failure of the Vishay product could result in personal injury or death. Customers using or selling Vishay products not expressly indicated for use in such applications do so at their own risk and agree to fully indemnify and hold Vishay and its distributors harmless from and against any and all claims, liabilities, expenses and damages arising or resulting in connection with such use or sale, including attorneys fees, even if such claim alleges that Vishay or its distributor was negligent regarding the design or manufacture of the part. Please contact authorized Vishay personnel to obtain written terms and conditions regarding products designed for such applications.

No license, express or implied, by estoppel or otherwise, to any intellectual property rights is granted by this document or by any conduct of Vishay. Product names and markings noted herein may be trademarks of their respective owners.