



AKD4385-SC

AK4385 Evaluation board Rev.1

General Description

The AKD4385-SC is an evaluation board for AK4385, which is 192kHz sampling 24Bit $\Delta\Sigma$ DAC. The AKD4385-SC includes a LPF which can add differential analog outputs from the AK4385 and also has a digital interface. Therefore, it is easy to evaluate the AK4385.

■ **Ordering Guide**

AKD4385-SC --- Evaluation board for AK4385

Function

- On-board Analog output buffer circuit
- On-board digital audio interface. (AK4113)

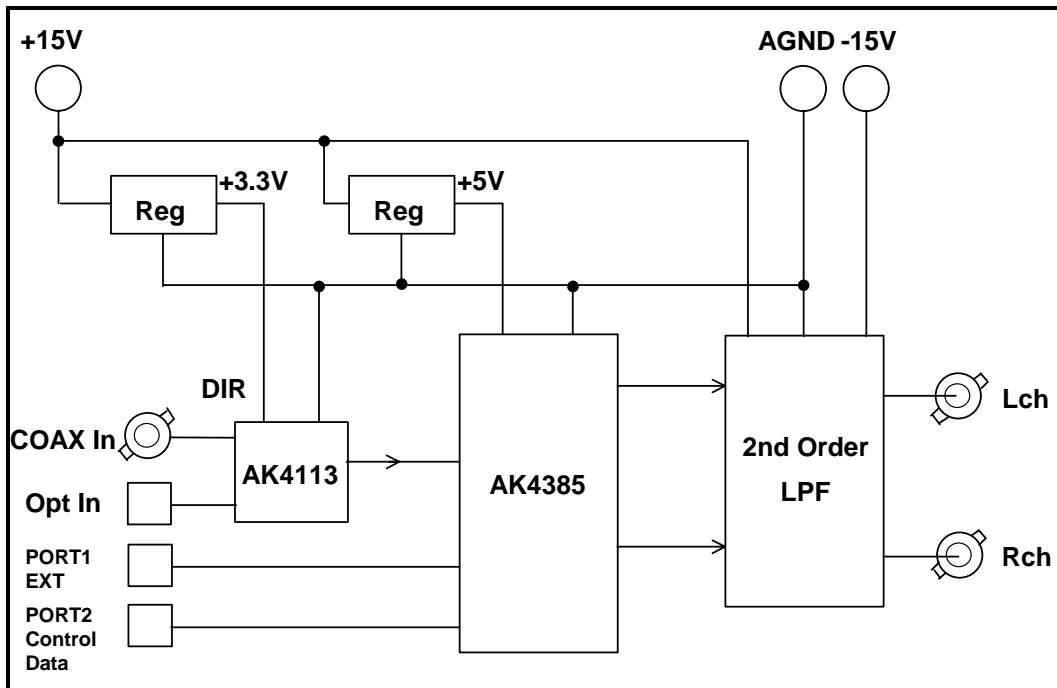

Figure 1. Block diagram

* Circuit diagram and PCB layout are attached at the end of this manual.

COAX is recommended for an evaluation of the Sound quality.

■ Operation sequence

1) Set up the power supply lines. (See “Other jumpers set-up”.)

Name	Color	Voltage	Comments	Attention
+15V	Red	+12~+15V	For regulator and op-amps.	This jack should be always connected to power supply.
-15V	Blue	-12~-15V	For op-amps.	This jack should be always connected to power supply.
AGND	Black	0V	GND	This jack should be always connected to power supply.

Table 1. Set up of power supply lines

Each supply line should be distributed from the power supply unit.

2) Set-up the jumper pins

3) Set-up the DIP switches. (See the followings.)

4) Power on

The AK4385 should be reset once by bringing SW1 (PDN) “L” upon power-up.

■ Evaluation mode

1. DIR (COAX) (default)

It is possible to evaluate the AK4385 by using CD disk. The DIR generates MCLK, BICK, LRCK and SDATA from the received data through BNC connector (J1). Setting of jumper is shown below.

COAX is recommended for an evaluation of the Sound quality.

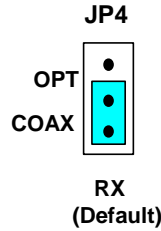

Figure 2. Jumper setting, when using DIR

2. DIR (Optical Link)

It is possible to evaluate the AK4385 by using CD disk. The DIR generates MCLK, BICK, LRCK and SDATA from the received data through optical connector (PORT3: TORX176). Setting of jumper is shown below.

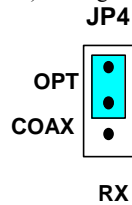

Figure 3. Jumper setting, when using DIR

3. All clocks are fed through the PORT1.

- R13, R15, R17, R18 : open
- R1, R2, R3, R8 : 100Ω or short (0Ω)

■ DIP Switch setting

[SW2]: AK4113 setting

No.	Pin	OFF	ON	Default
1	OCKS1	AK4113 Master Clock setting Refer to Table4		ON
2	OCKS0			OFF

Table 2. SW2 setting

The frequency of the master clock output is set by OCKS0 and OCKS1 as shown in Table 4.

OCKS1	OCKS0	MCLK Frequency
0	0	256fs @fs=88.2/96kHz
1	0	512fs @32/44.1/48kHz
1	1	128fs @176.4/192kHz

Default

Table 3. MCLK Clock

■ SW1 setting

[SW1](PDN): Reset of AK4385. Select “H” during operation.

■ External Analog Filter Circuit

The 2nd order LPF ($f_c=93.2\text{kHz}$, $Q=0.712$) which adds differential outputs of the AK4385 is implemented on the board. When the further attenuation of the out-of-band noise is needed, some additional LPF is required. Analog signal is output through BNC connectors on the board. And the output level of the AK4382A is $5.5\text{Vpp}@5\text{V}$.

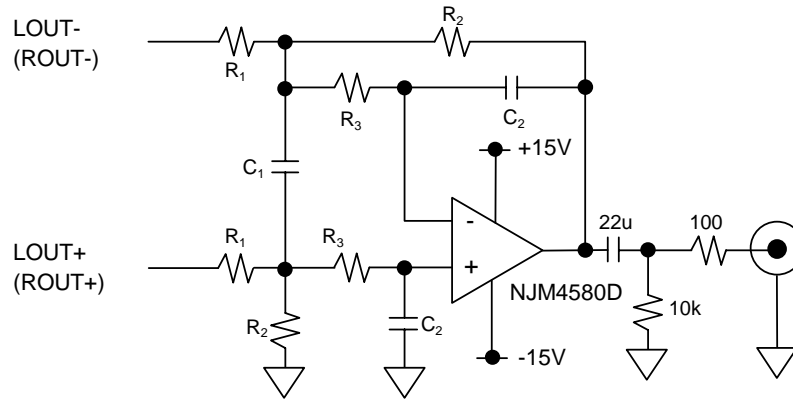

Figure 4. On-board analog filter

R ₁	R ₂	R ₃	C ₁	C ₂
4.7k	4.7k	200	3300p	470p

Table 4. The value of R, C on this board

f _{in}	20kHz	40kHz	80kHz
Frequency Response	-0.003dB	-0.122dB	-1.821dB

Table 5. Frequency Response of LPF

<Calculation>

$$\text{Amplitude} = 20 \log \frac{K}{\sqrt{[1-(f/f_c)^2]^2 + [(1/Q)(f/f_c)]^2}} \text{ [dB]},$$

$$K = \frac{R_2}{R_1},$$

$$f_c = \frac{\omega_0}{2\pi},$$

$$\omega_0 = \frac{1}{\sqrt{2C_1C_2R_2R_3}},$$

$$Q = \frac{2C_1\omega_0}{\frac{1}{R_1} + \frac{1}{R_2} + \frac{1}{R_3}}.$$

Control Software Manual

■ Set-up of evaluation board and control software

1. Set up the AKD4385-SC according to previous term.
2. Connect IBM-AT compatible PC with AKD4385-SC by 10-line type flat cable (packed with AKD4385-SC). Take care of the direction of 10pin header. (Please install the driver in the CD-ROM when this control software is used on Windows 2000/XP. Please refer “Installation Manual of Control Software Driver by AKM device control software”. In case of Windows95/98/ME, this installation is not needed. This control software does not operate on Windows NT.)
3. Insert the CD-ROM labeled “AKD4385-SC Evaluation Kit” into the CD-ROM drive.
4. Access the CD-ROM drive and double-click the icon of “AKD4385-SC.exe” to set up the control program.
5. Then please evaluate according to the follows.

■ Operation flow

Keep the following flow.

1. Set up the control program according to explanation above.
2. Click “Port Reset” button.

■ Explanation of each buttons

- | | |
|----------------------|---|
| 1. [Port Reset] : | Set up the USB interface board (AKDUSBIF-A) in case using the board. |
| 2. [Write default] : | Initialize the register of AK4385. |
| 3. [All Write] : | Write all registers that is currently displayed. |
| 4. [Function1] : | Dialog to write data by keyboard operation. |
| 5. [Function2] : | Dialog to write data by keyboard operation. |
| 6. [Function3] : | The sequence of register setting can be set and executed. |
| 7. [Function4] : | The sequence that is created on [Function3] can be assigned to buttons and executed. |
| 8. [Function5]: | The register setting that is created by [SAVE] function on main window can be assigned to buttons and executed. |
| 9. [SAVE] : | Save the current register setting. |
| 10. [OPEN] : | Write the saved values to all register. |
| 11. [Write] : | Dialog to write data by mouse operation. |

■ Indication of data

Input data is indicated on the register map. Red letter indicates “H” or “1” and blue one indicates “L” or “0”. Blank is the part that is not defined in the datasheet.

■ Explanation of each dialog

1. [Write Dialog] : Dialog to write data by mouse operation

There are dialogs corresponding to each register.

Click the [Write] button corresponding to each register to set up the dialog. If you check the check box, data becomes “H” or “1”. If not, “L” or “0”.

When writing the input data to AK4385, click [OK] button. If not, click [Cancel] button.

2. [Function1 Dialog] : Dialog to write data by keyboard operation

Address Box: Input registers address in 2 figures of hexadecimal.

Data Box: Input registers data in 2 figures of hexadecimal.

When writing the input data to AK4385, click [OK] button. If not, click [Cancel] button.

3. [Function2 Dialog] : Dialog to evaluate ATT

Address Box: Input registers address in 2 figures of hexadecimal.

Start Data Box: Input starts data in 2 figures of hexadecimal.

End Data Box: Input end data in 2 figures of hexadecimal.

Interval Box: Data is written to AK4642 by this interval.

Step Box: Data changes by this step.

Mode Select Box:

With checking this check box, data reaches end data, and returns to start data.

[Example] Start Data = 00, End Data = 09

Data flow: 00 01 02 03 04 05 06 07 08 09 09 08 07 06 05 04 03 02 01 00

Without checking this check box, data reaches end data, but does not return to start data.

[Example] Start Data = 00, End Data = 09

Data flow: 00 01 02 03 04 05 06 07 08 09

When writing the input data to AK4385, click [OK] button. If not, click [Cancel] button.

4. [Save] and [Open]

4-1. [Save]

Save the current register setting data. The extension of file name is “akr”.

(Operation flow)

- (1) Click [Save] Button.
- (2) Set the file name and push [Save] Button. The extension of file name is “akr”.

4-2. [Open]

The register setting data saved by [Save] is written to AK4385. The file type is the same as [Save].

(Operation flow)

- (1) Click [Open] Button.
- (2) Select the file (*.akr) and Click [Open] Button.

5. [Function3 Dialog]

The sequence of register setting can be set and executed.

(1) Click [F3] Button.

(2) Set the control sequence.

Set the address, Data and Interval time. Set “-1” to the address of the step where the sequence should be paused.

(3) Click [Start] button. Then this sequence is executed.

The sequence is paused at the step of Interval="-1". Click [START] button, the sequence restarts from the paused step.

This sequence can be saved and opened by [Save] and [Open] button on the Function3 window. The extension of file name is “aks”.

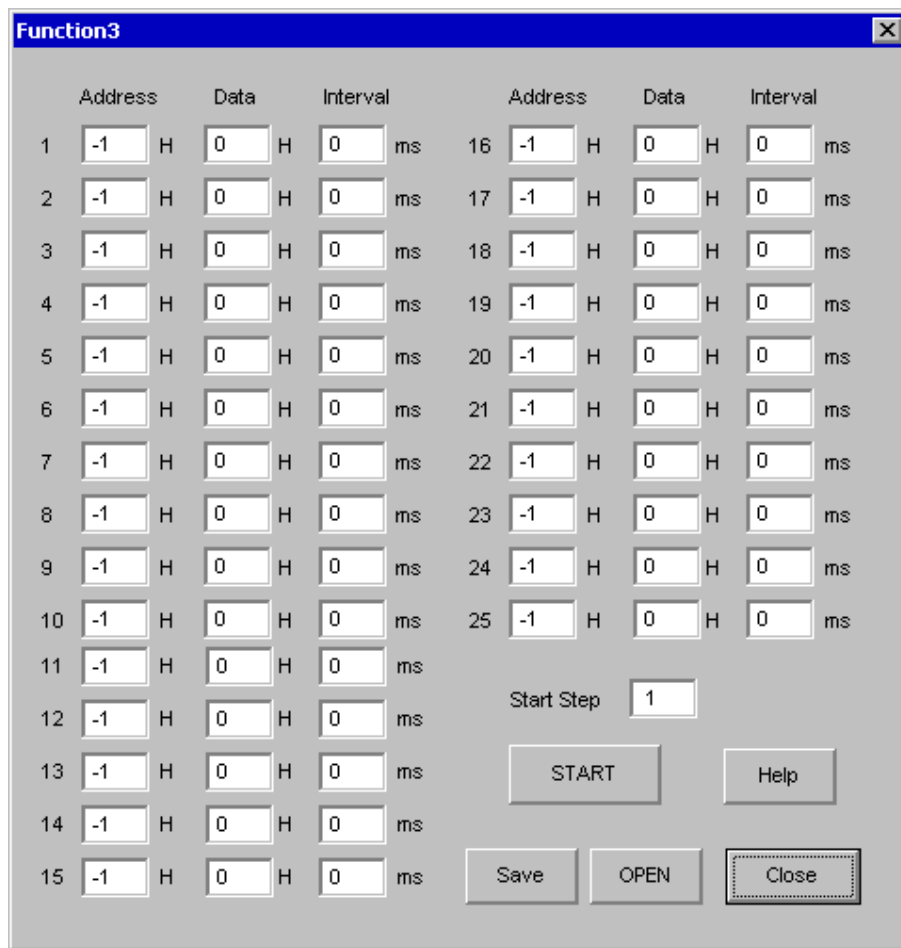

Figure 4. Window of [F3]

6. [Function4 Dialog]

The sequence that is created on [Function3] can be assigned to buttons and executed. When [F4] button is clicked, the window as shown in Figure 5 opens.

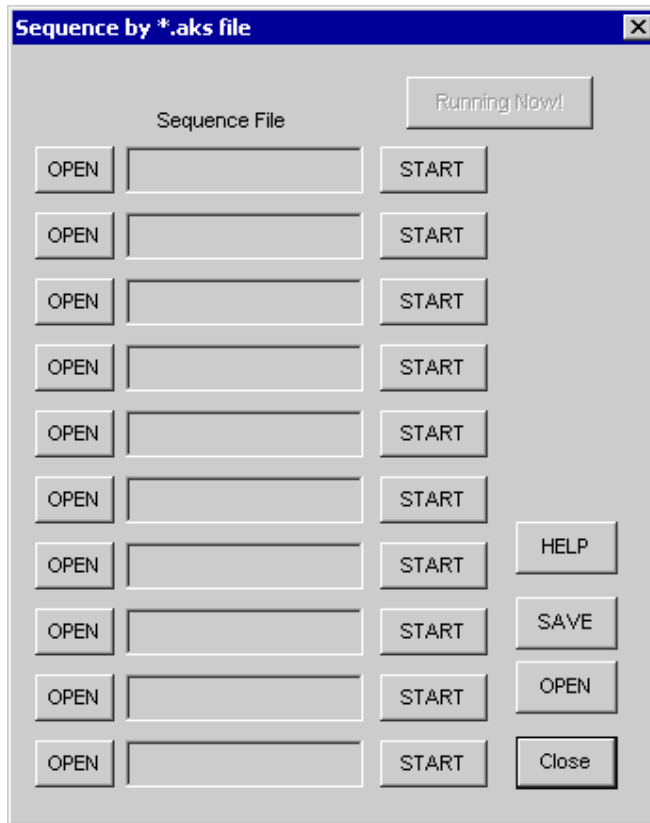

Figure 5. [F4] window

6-1. [OPEN] buttons on left side and [START] buttons

(1) Click [OPEN] button and select the sequence file (*.aks).

The sequence file name is displayed as shown in Figure 6.

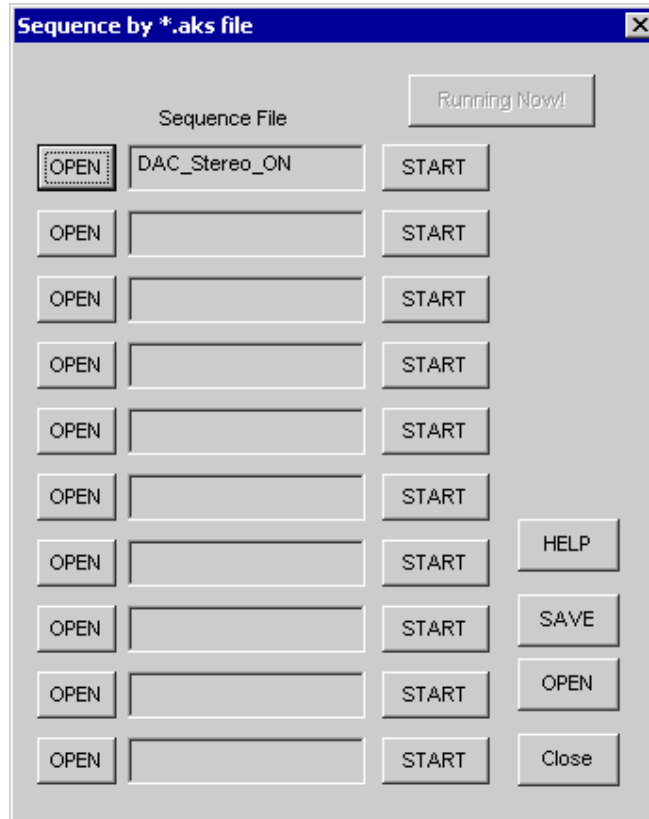

Figure 6. [F4] window(2)

(2) Click [START] button, then the sequence is executed.

6-2. [SAVE] and [OPEN] buttons on right side

[SAVE] : The sequence file names can assign be saved. The file name is *.ak4.

[OPEN] : The sequence file names assign that are saved in *.ak4 are loaded.

6-3. Note

(1) This function doesn't support the pause function of sequence function.

(2) All files need to be in same folder used by [SAVE] and [OPEN] function on right side.

(3) When the sequence is changed in [Function3], the file should be loaded again in order to reflect the change.

7. [Function5 Dialog]

The register setting that is created by [SAVE] function on main window can be assigned to buttons and executed. When [F5] button is clicked, the following window as shown in Figure 7 opens.

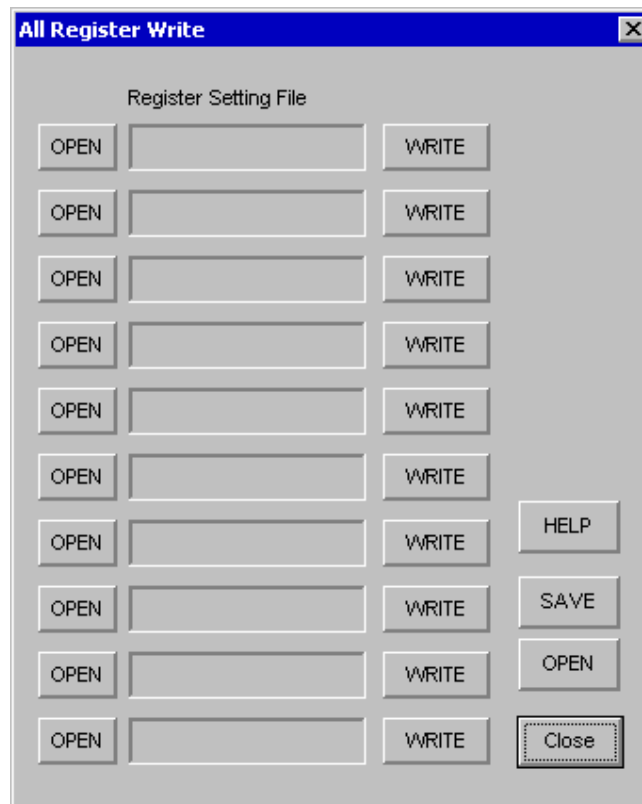

Figure 7. [F5] window

7-1. [OPEN] buttons on left side and [WRITE] button

- (1) Click [OPEN] button and select the register setting file (*.akr).
- (2) Click [WRITE] button, then the register setting is executed.

7-2. [SAVE] and [OPEN] buttons on right side

[SAVE] : The register setting file names assign can be saved. The file name is *.ak5.

[OPEN] : The register setting file names assign that are saved in *.ak5 are loaded.

7-3. Note

- (1) All files need to be in same folder used by [SAVE] and [OPEN] function on right side.
- (2) When the register setting is changed by [Save] Button in main window, the file should be loaded again in order to reflect the change.

Measurement Results

[Measurement condition]

- Measurement unit : Audio Precision System two Cascade (AP2)
- MCLK : 512fs (44.1kHz), 256fs (96kHz), 128fs (192kHz)
- BICK : 64fs
- fs : 44.1kHz, 96kHz
- Bit : 24bit
- Power Supply : VDD=5V
- Interface : Internal DIR (44.1kHz, 96kHz)
- Temperature : Room

fs=44.1kHz

Parameter	Input signal	Measurement filter	Lch	Rch
S/(N+D)	1kHz, 0dB	20kLPF	95.4 dB	95.3 dB
DR	1kHz, -60dB	22kLPF, A-weighted	108.7 dB	108.7 dB
S/N	"0" data	22kLPF, A-weighted	109.3 dB	109.3 dB

fs=96kHz

Parameter	Input signal	Measurement filter	Lch	Rch
S/(N+D)	1kHz, 0dB	40kLPF	91.3 dB	91.5 dB
DR	1kHz, -60dB	40kLPF	104.4 dB	104.4 dB
		22kLPF, A-weighted	107.8 dB	107.8 dB
S/N	"0" data	40kLPF	105.7 dB	105.6 dB
		22kLPF, A-weighted	108.9 dB	108.8 dB

fs=192kHz

Parameter	Input signal	Measurement filter	Lch	Rch
S/(N+D)	1kHz, 0dB	40kLPF	92.7 dB	93.2 dB
DR	1kHz, -60dB	40kLPF	103.4 dB	103.4 dB
		22kLPF, A-weighted	106.3 dB	106.3 dB
S/N	"0" data	40kLPF	104.6 dB	104.6 dB
		22kLPF, A-weighted	108.0 dB	107.0 dB

Plots

(fs=44.1kHz)

AKM

AK4385 FFT
VDD=5V, fs=44.1kHz, MCLK=512, 0dBFS input, fin=1kHz

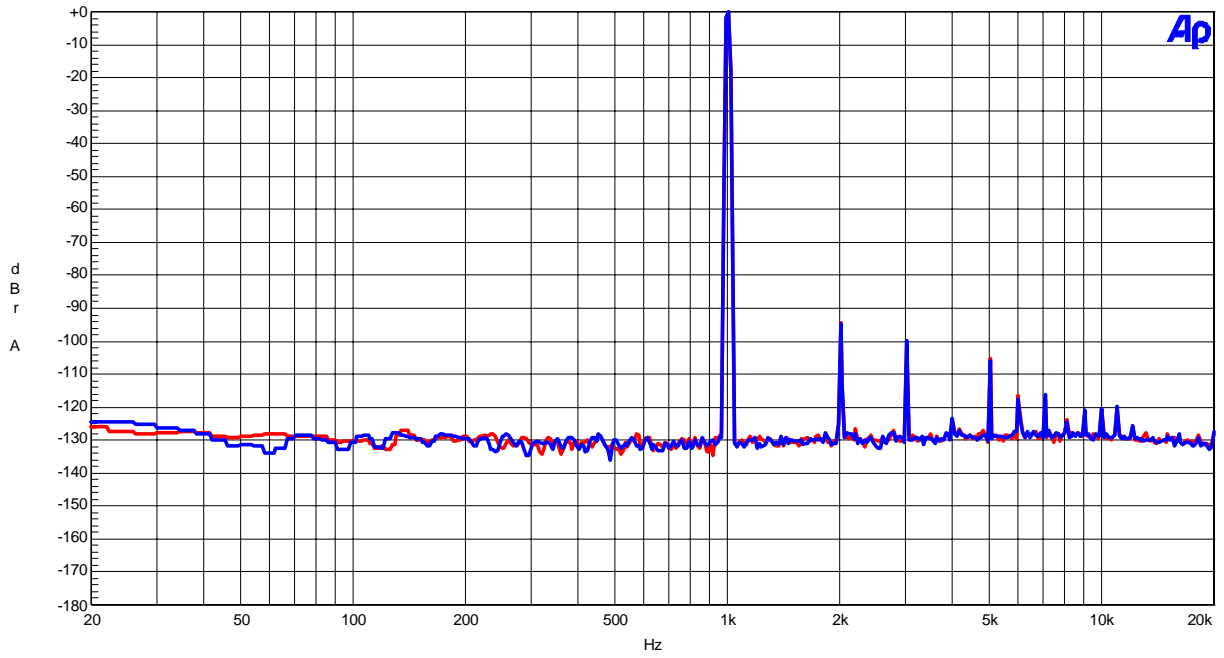

Figure 8. FFT (fin=1kHz, 0dBFS input)

AKM

AK4385 FFT
VDD=5V, fs=44.1kHz, MCLK=512, -60dBFS input, fin=1kHz

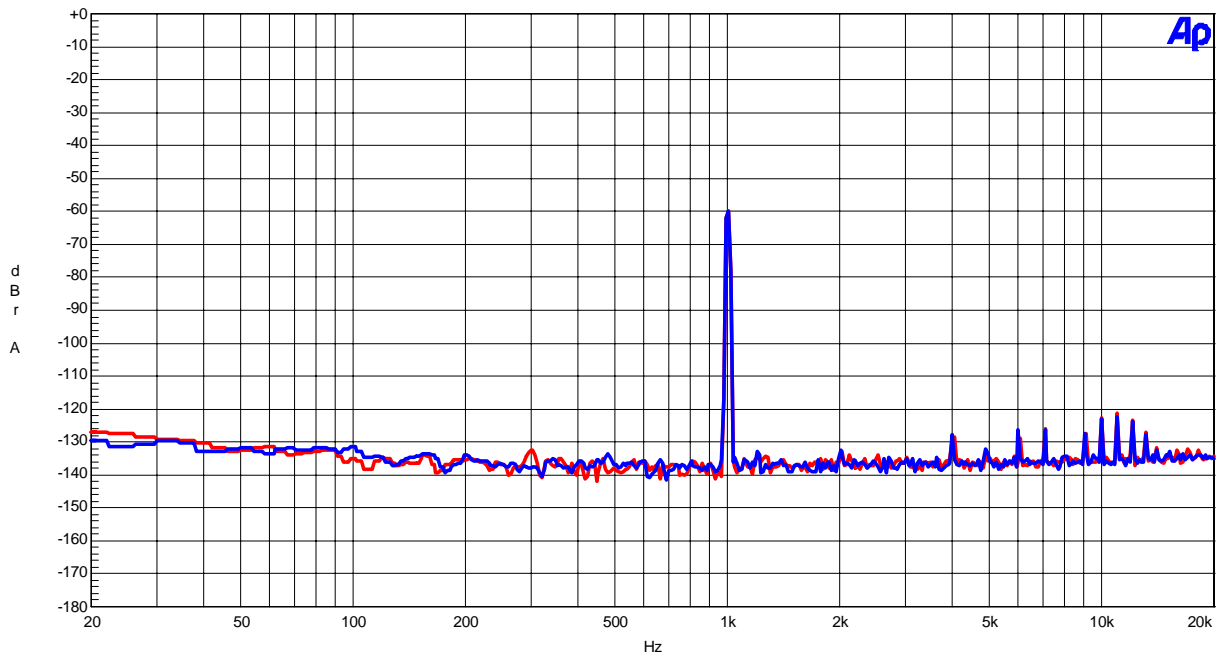

Figure 9. FFT (fin=1kHz, -60dBFS input)

(fs=44.1kHz)

AKM

AK4385 FFT
VDD=5V, fs=44.1kHz, MCLK=512, fin=No signal

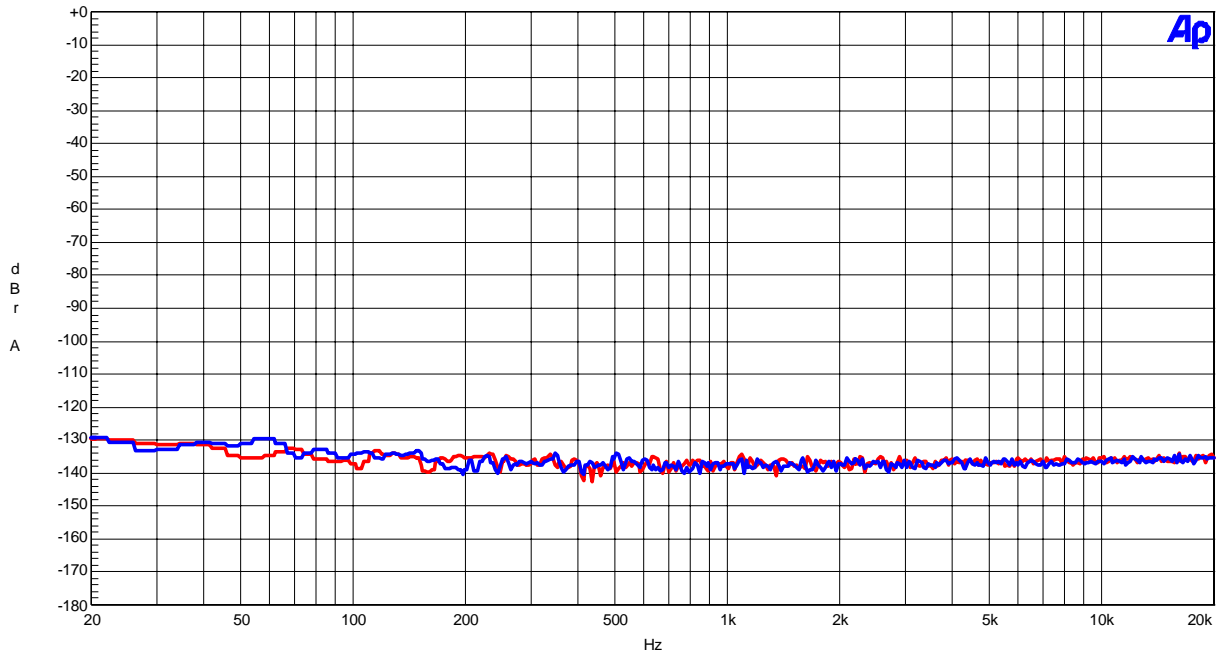

Figure 10. FFT (Noise Floor)

AKM

AK4385 FFT Out-of-band noise
VDD=5V, fs=44.1kHz, MCLK=512fs, fin=No signal

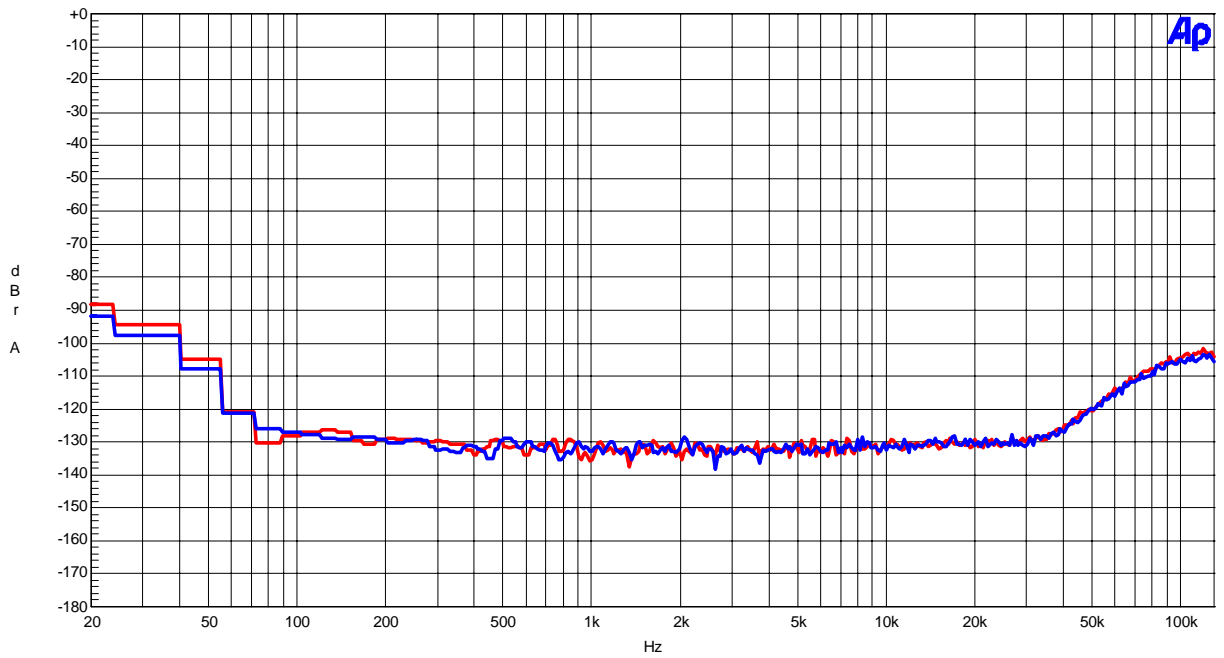

Figure 11. FFT (Out of band noise)

(fs=44.1kHz)

AKM

AK4385 THD+N vs. Input Level
VDD=5V, fs=44.1kHz, MCLK=512fs, fin=1kHz

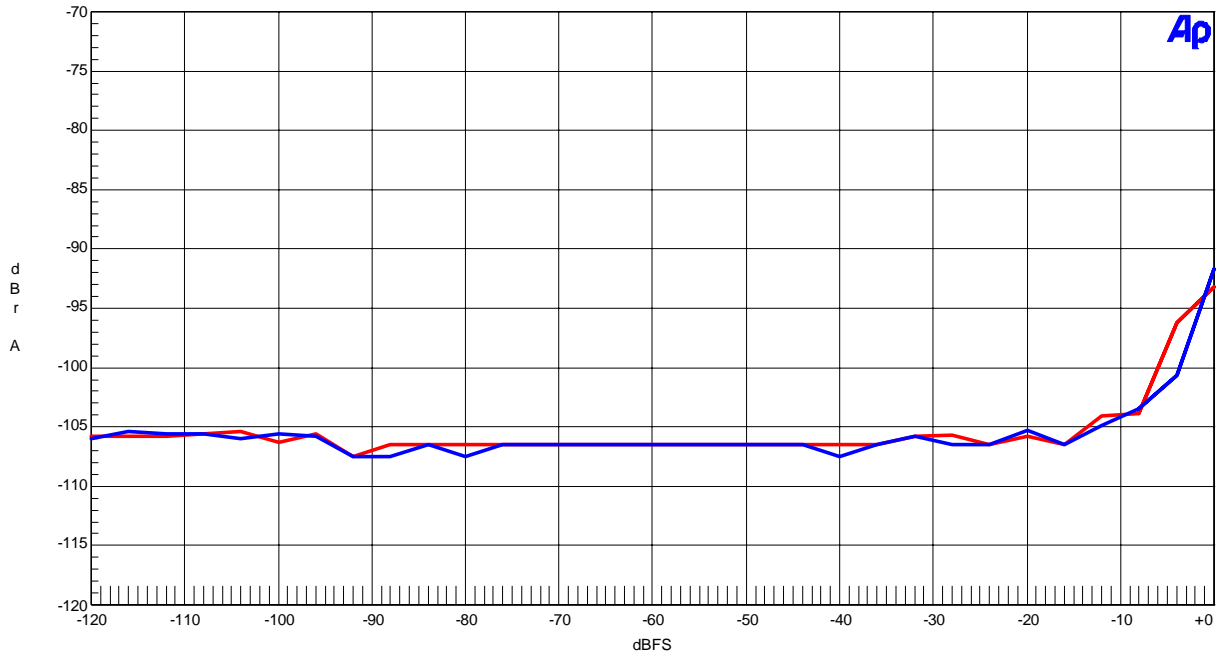

Figure 12 . THD+N vs. Input level (fin=1kHz)

AKM

AK4385 THD+N vs. Input Frequency
VDD=5V, fs=44.1kHz, MCLK=512fs, 0dBFS input

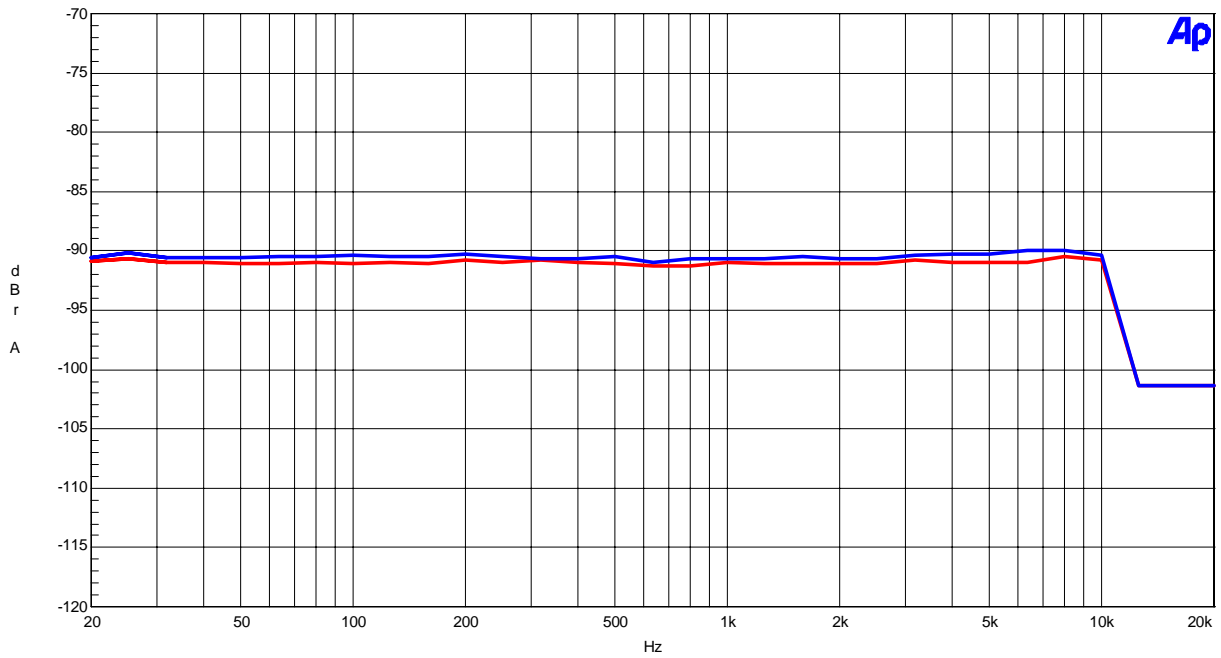

Figure 13 . THD+N vs. Input Frequency (0dBFS input)

(fs=44.1kHz)

AKM

AK4385 Linearity
VDD=5V fs=44.1kHz, MCLK=512fs, fin=1kHz

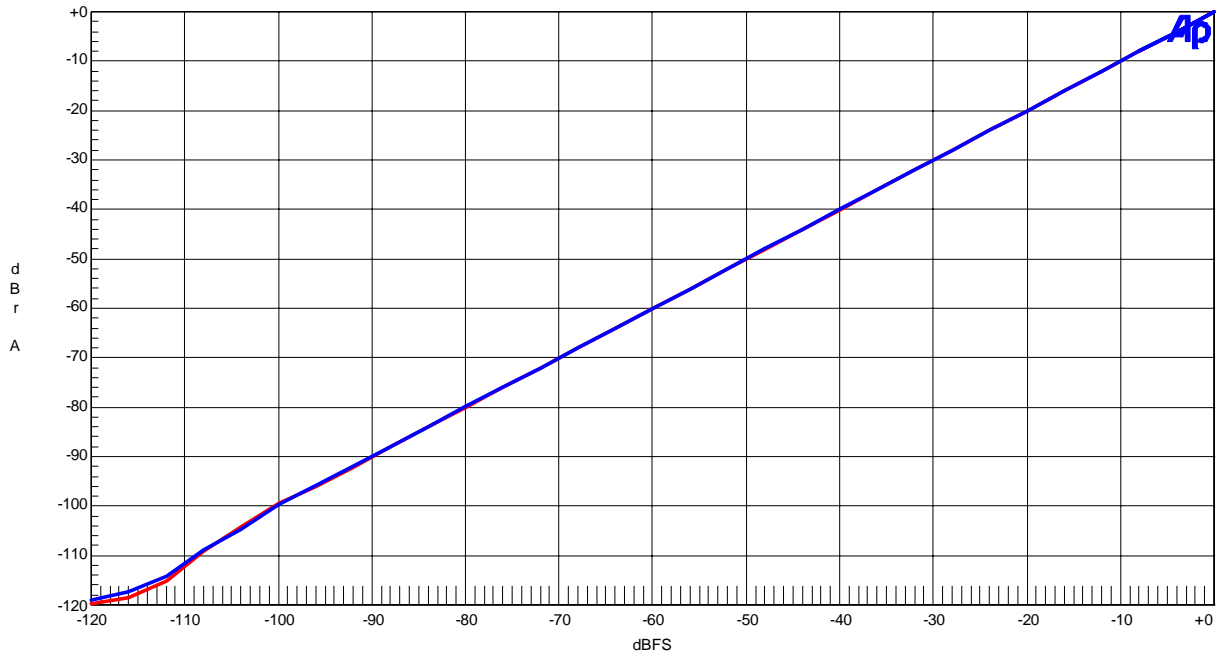

Figure 14. Linearity (fin=1kHz)

AKM

AK4385 Frequency Response
VDD=5V, fs=44.1kHz, MCLK=512fs, 0dBFS input

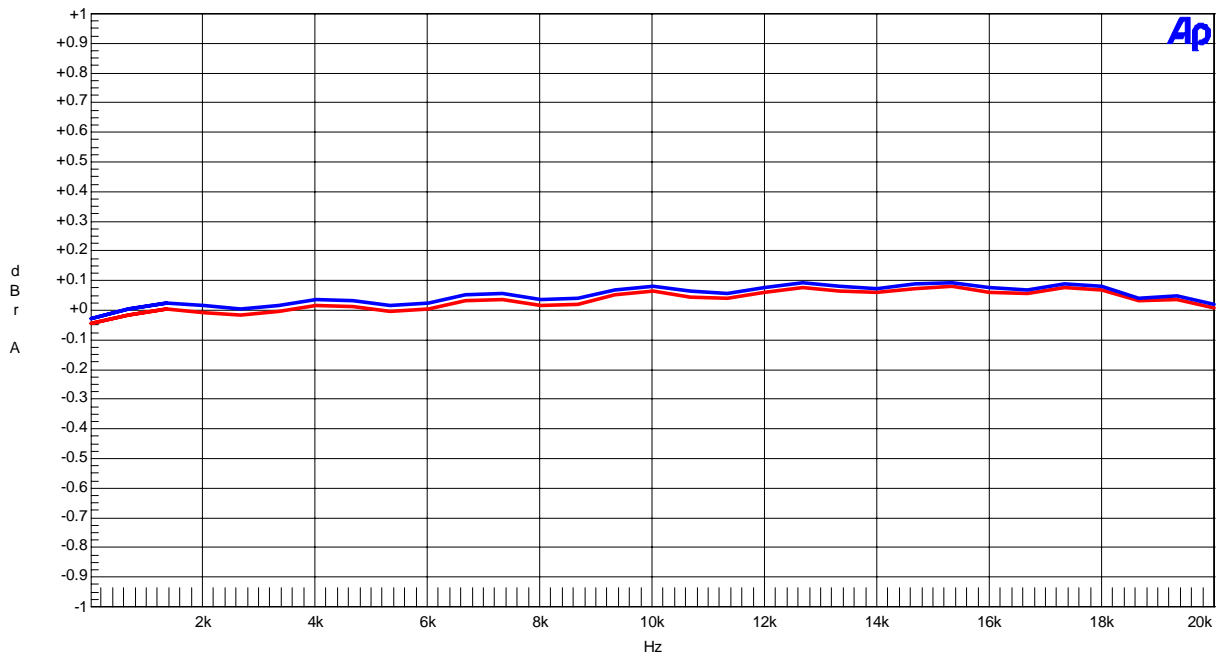

Figure 15. Frequency Response (0dBFS input)

(fs=44.1kHz)

AKM

AK4385 Crosstalk (Red=Lch, Blue=Rch)
VDD=5V, fs=44.1kHz, MCLK=512fs, 0dBFS input

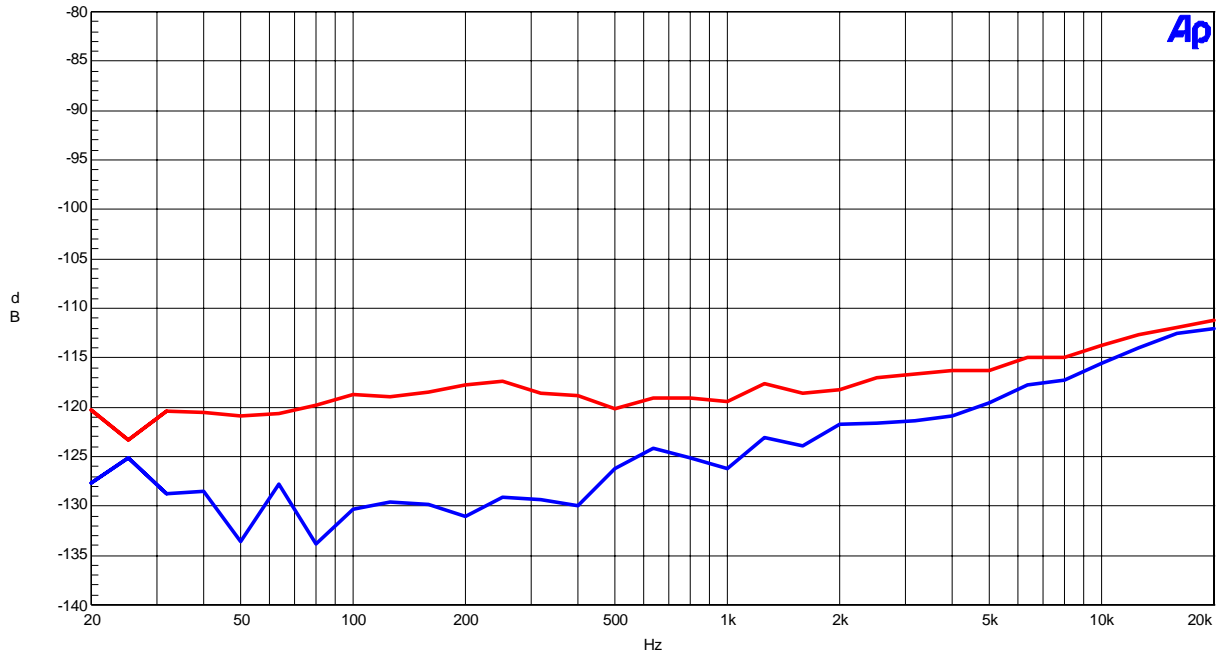

Figure 16. Crosstalk (0dBFS input)

(fs=96kHz)

AKM

AK4385 FFT
VDD=5V, fs=96kHz, MCLK=256fs, 0dBFS input, fin=1kHz

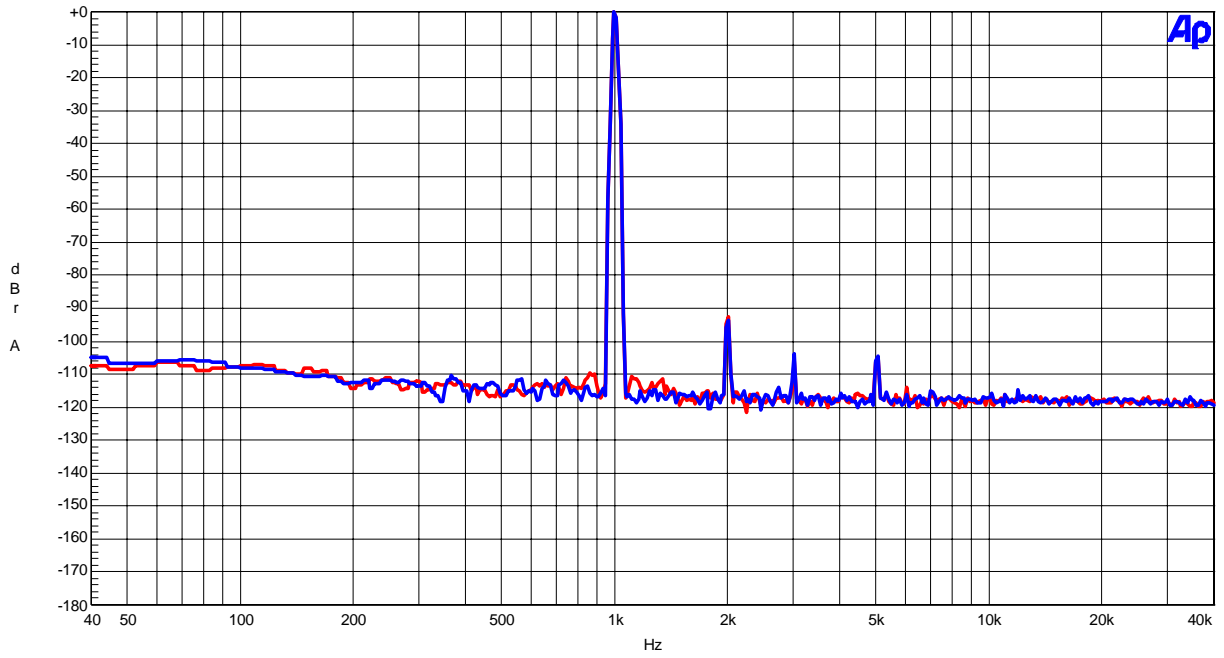

Figure 17. FFT (fin=1kHz, 0dBFS input)

AKM

AK4385 FFT
fs=96kHz, MCLK=256fs, fin=1kHz, 0dBFS input, Notch=ON

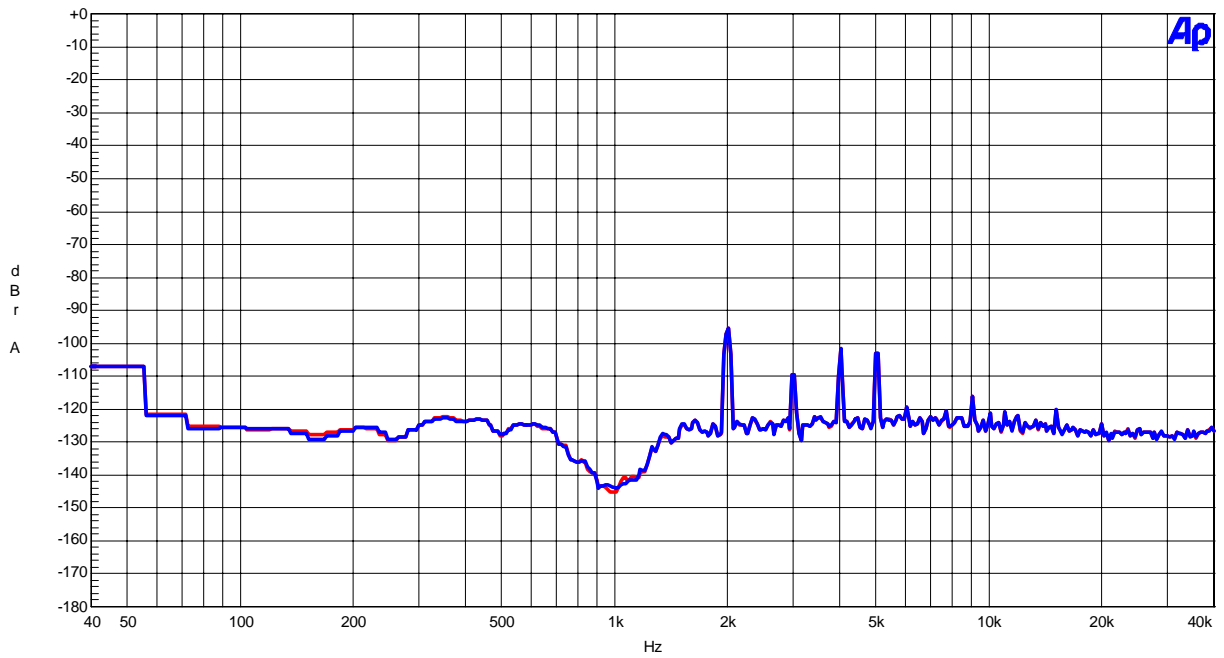

Figure 18. FFT(fin=1kHz, 0dBFS input, Notch)

(fs=96kHz)

AKM

AK4385 FFT

VDD=5V, fs=96kHz, MCLK=256fs, -60dBFS input, fin=1kHz

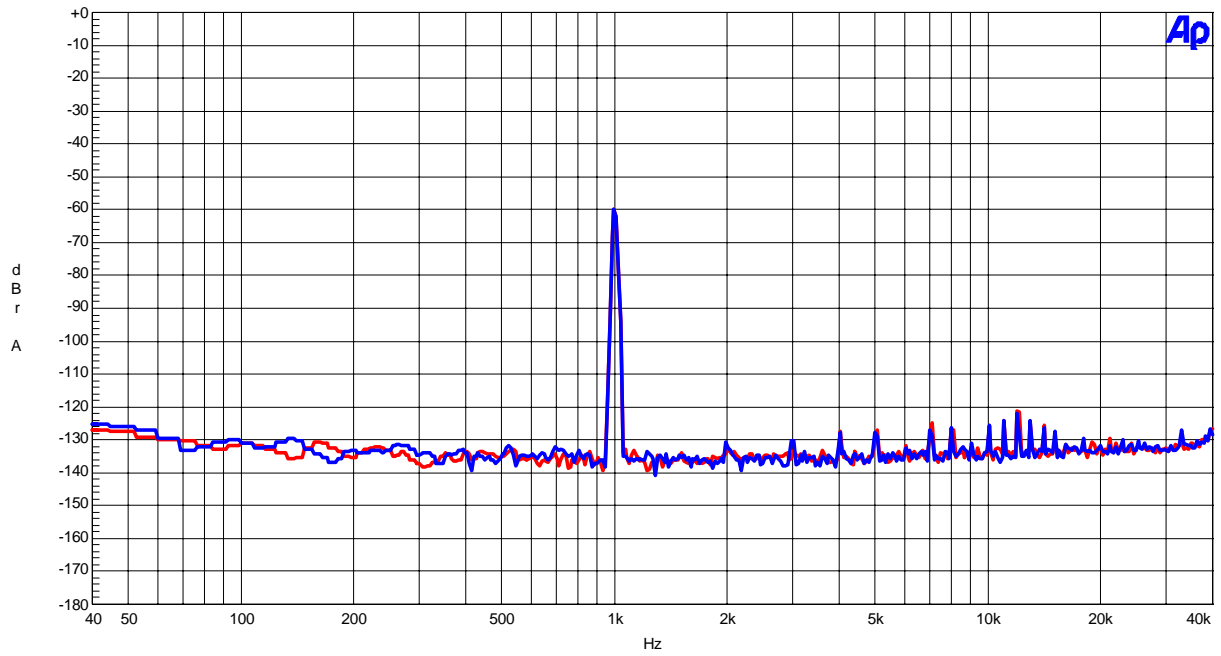

Figure 19. FFT (fin=1kHz, -60dBFS input)

AKM

AK4385 FFT

VDD=5V, fs=96kHz, fin=No signal

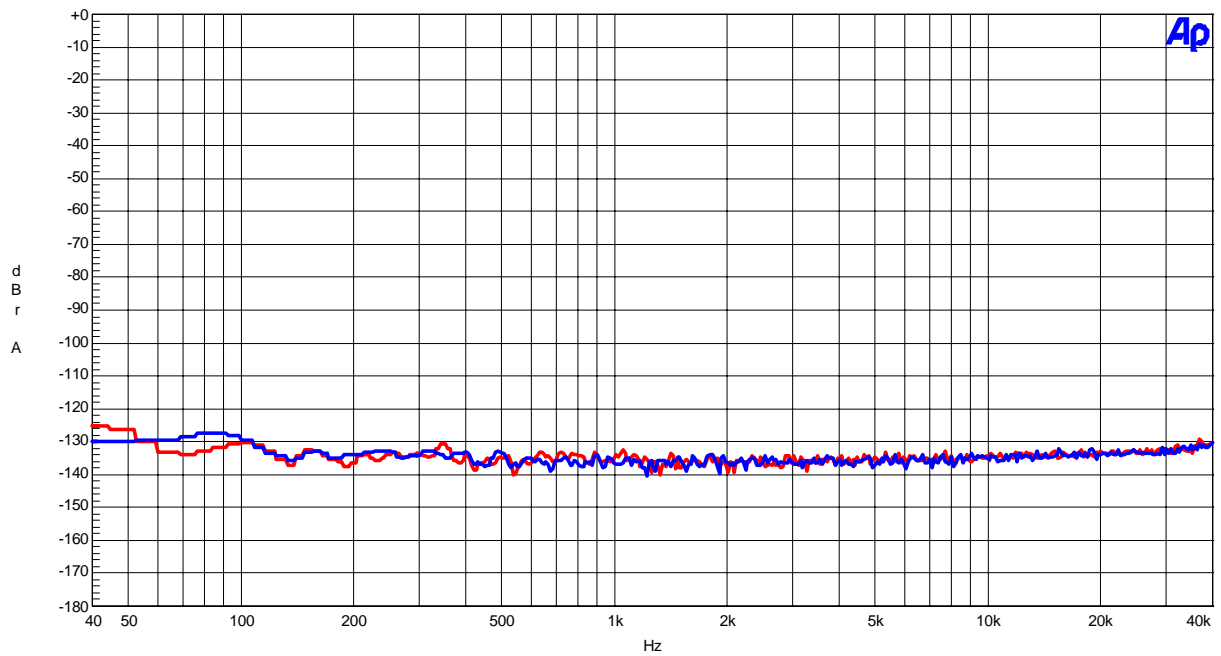

Figure 20. FFT (Noise Floor)

(fs=96kHz)

AKM

AK4385 THD+N vs. Input Level
VDD=5V, fs=96kHz, MCLK=256fs, fin=1kHz

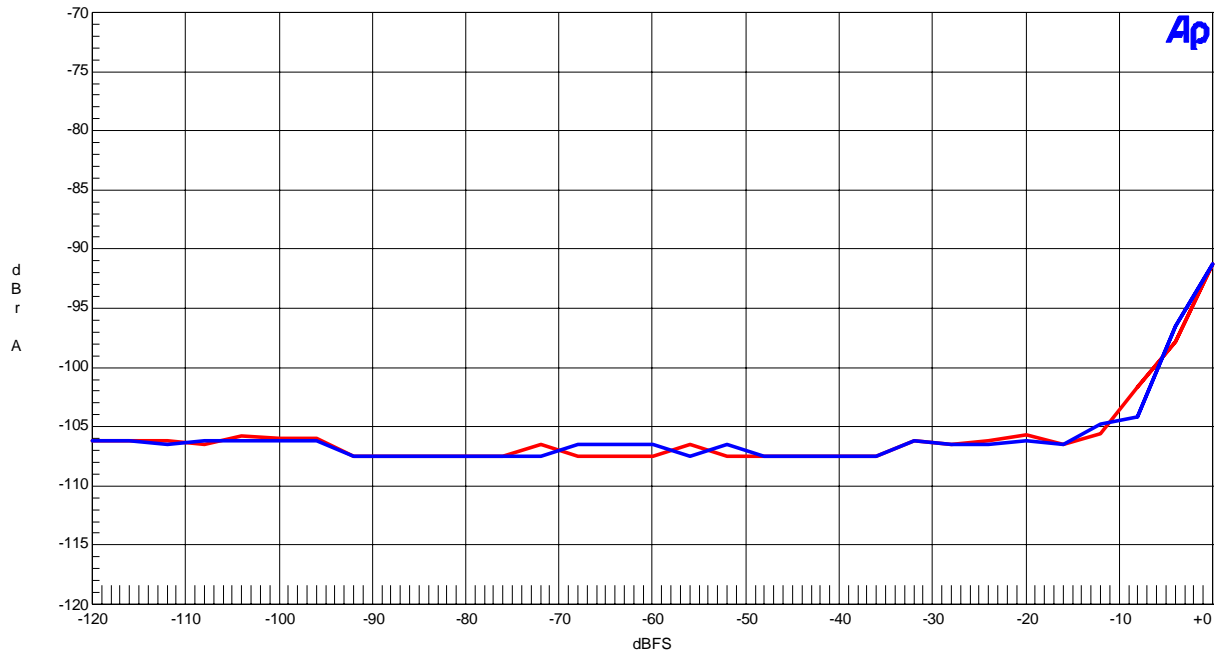

Figure 21. THD+N vs. Input level (fin=1kHz)

AKM

AK4385 THD+N vs. Input Frequency
VDD=5V, fs=96kHz, MCLK=256fs, 0dBFS input

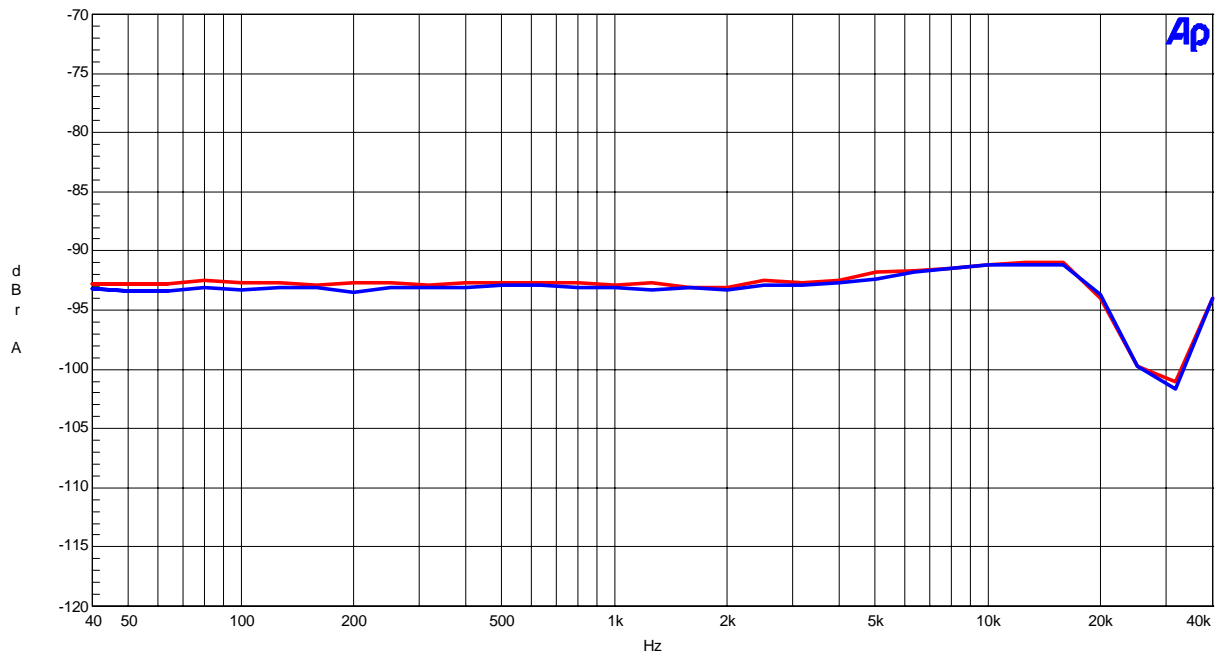

Figure 22. THD+N vs. Input Frequency (0dBFS input)

(fs=96kHz)

AKM

AK4385 Linearity
VDD=5V, fs=96kHz, MCLK=256fs, fin=1kHz

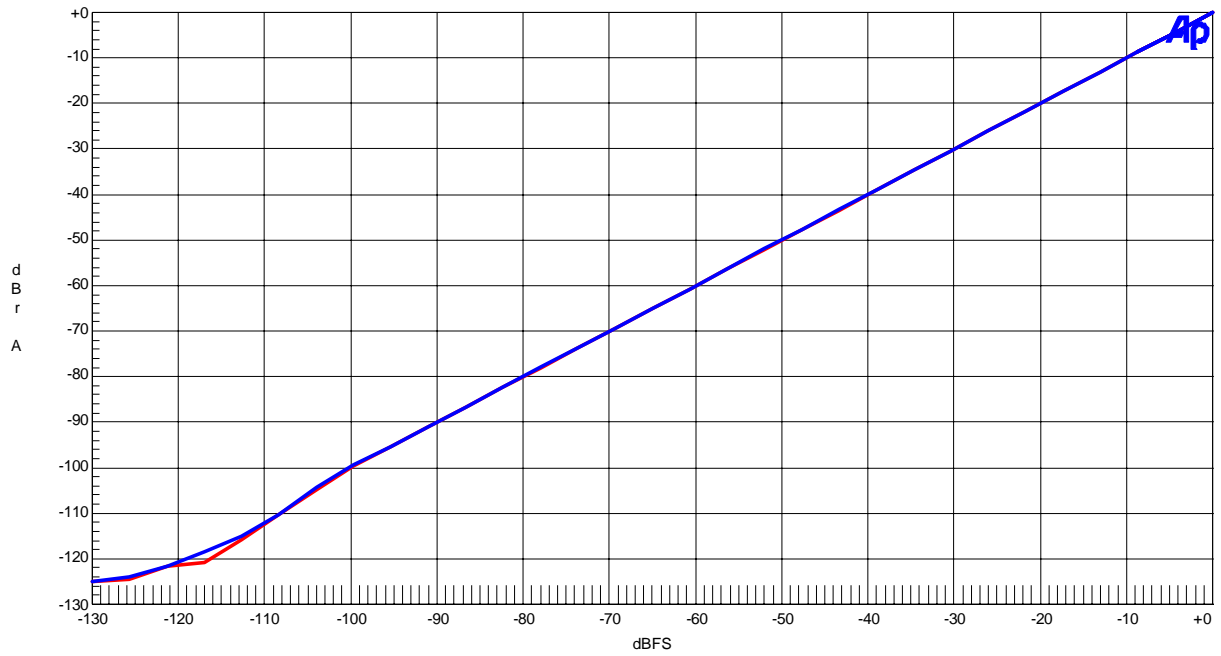

Figure 23. Linearity (fin=1kHz)

AKM

AK4385 Frequency Response
VDD=5V, fs=96kHz, MCLK=256fs, 0dBFS input

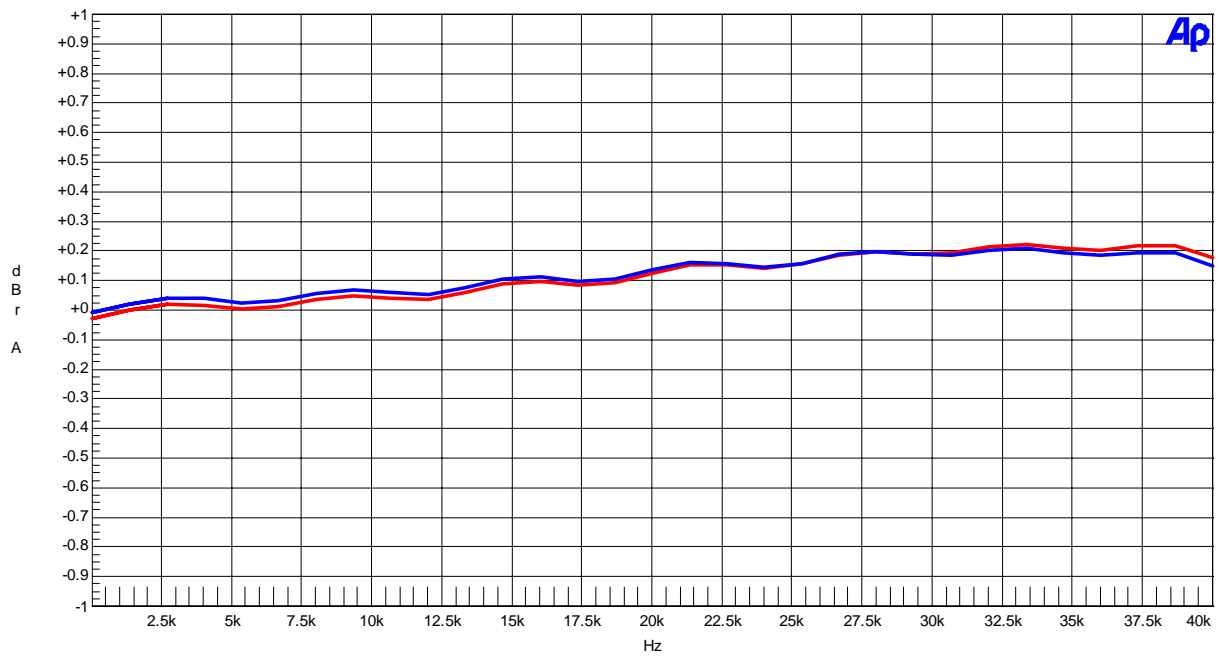

Figure 24. Frequency Response (0dBFS input)

(fs=96kHz)

AKM

AK4385 Crosstalk (Red=Lch, Blue=Rch)
VDD=5V, fs=96kHz, MCLK=256fs, 0dBFS input

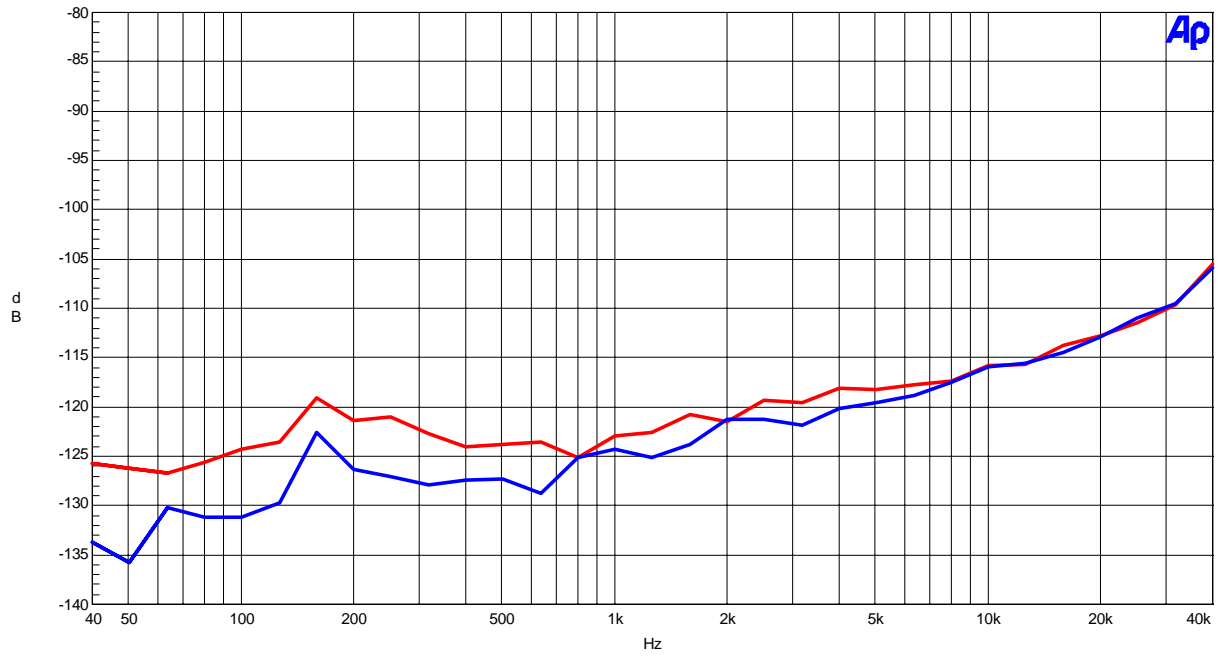

Figure 25. Crosstalk (0dBFS input)

(fs=192kHz)

AKM

AK4385 FFT
VDD=5V, fs=192kHz, MCLK=128fs, 0dBFS input, fin=1kHz

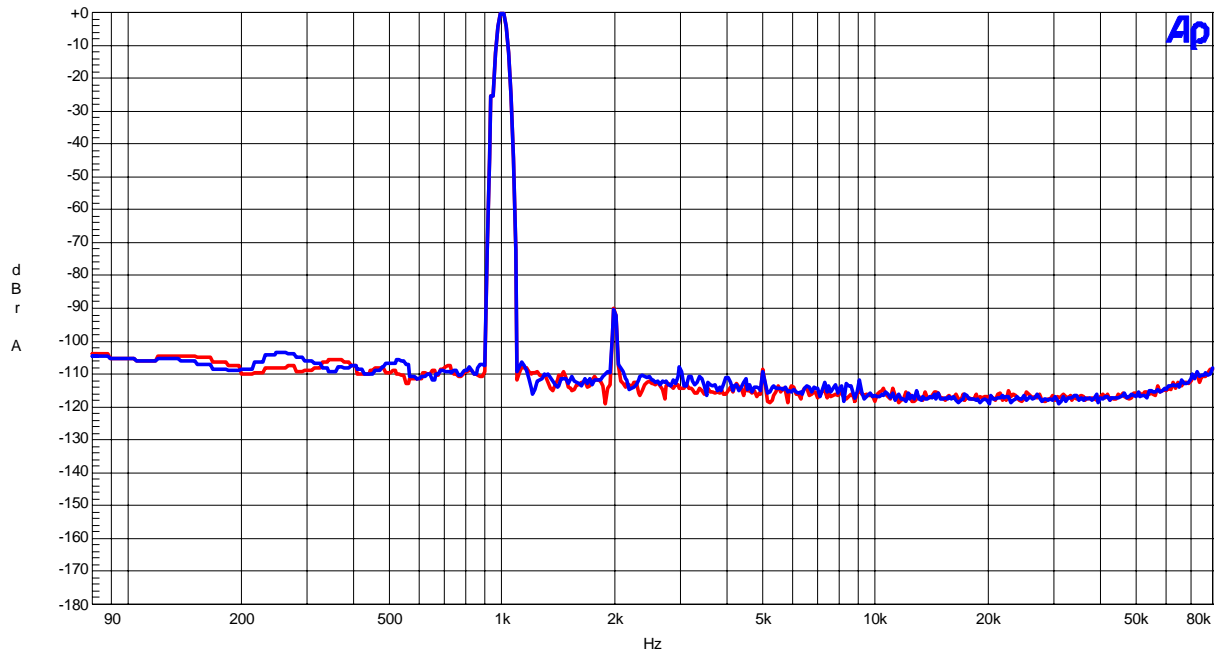

Figure 26. FFT (fin=1kHz, 0dBFS input)

AKM

AK4385 FFT
VDD=5V, fs=192kHz, MCLK=128fs, 0dBFS input, fin=1kHz, Notch=ON

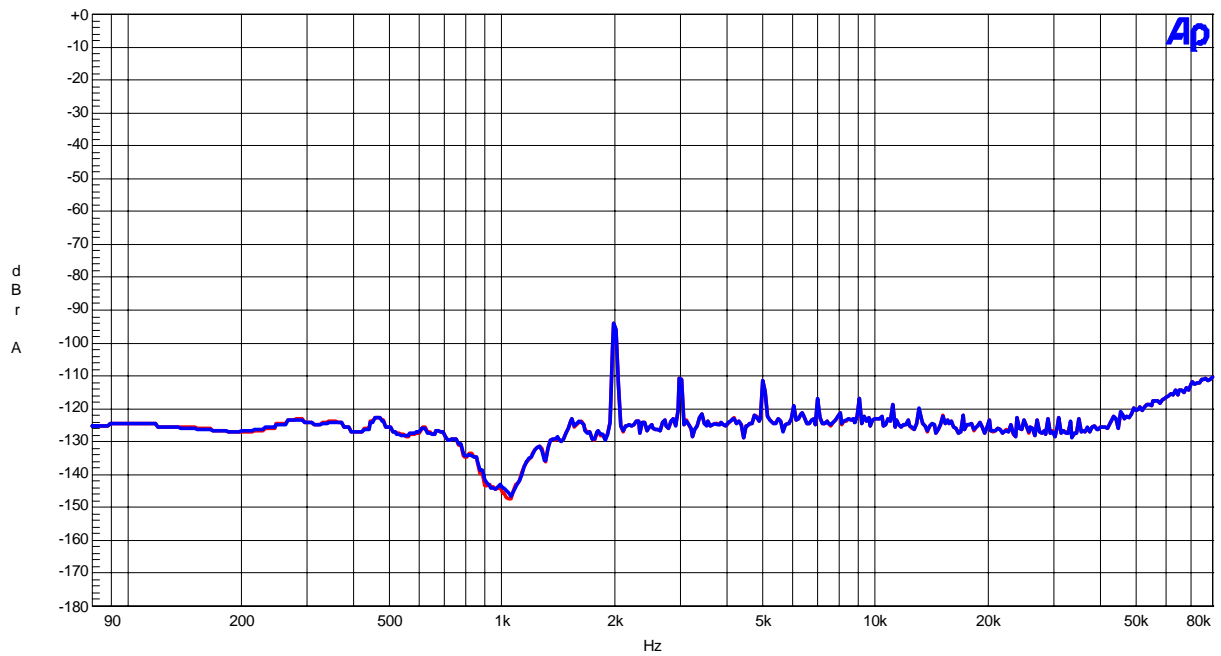

Figure 27. FFT (fin=1kHz, 0dBFS input, Notch)

(fs=192kHz)

AKM

AK4385 FFT
VDD=5V, fs=192kHz, MCLK=128fs, -60dBFS input, fin=1kHz

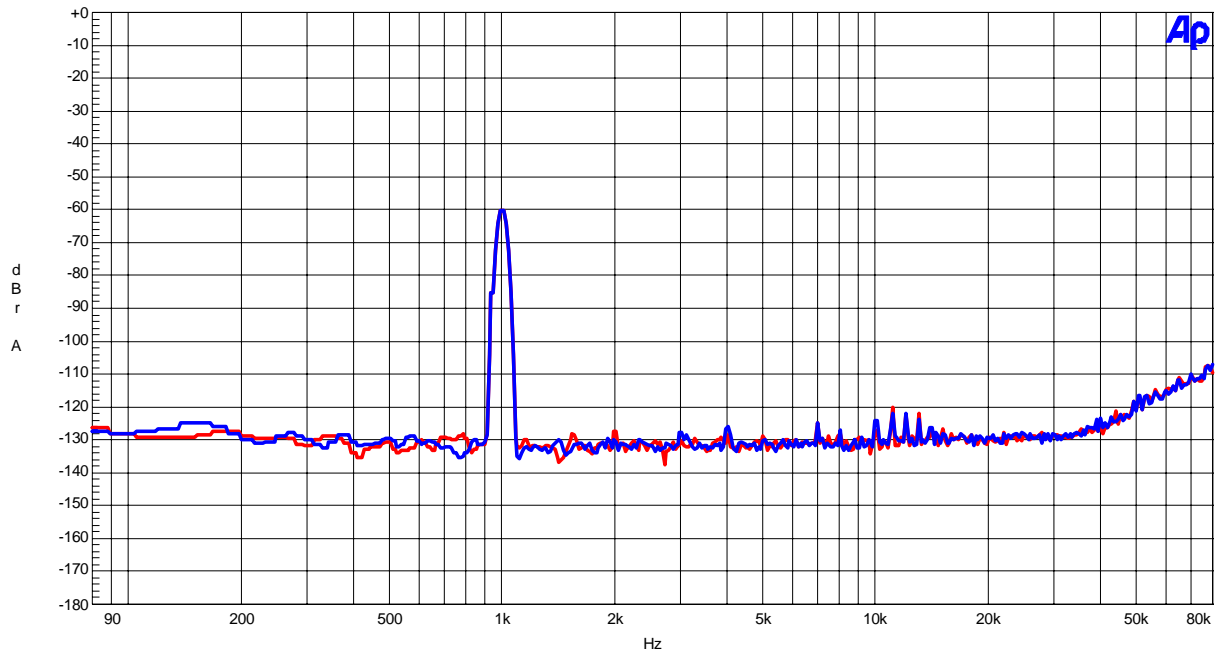

Figure 28. FFT (fin=1kHz, -60dBFS input)

AKM

AK4385 FFT
VDD=5V, fs=192kHz, MCLK=128fs, fin=No signal

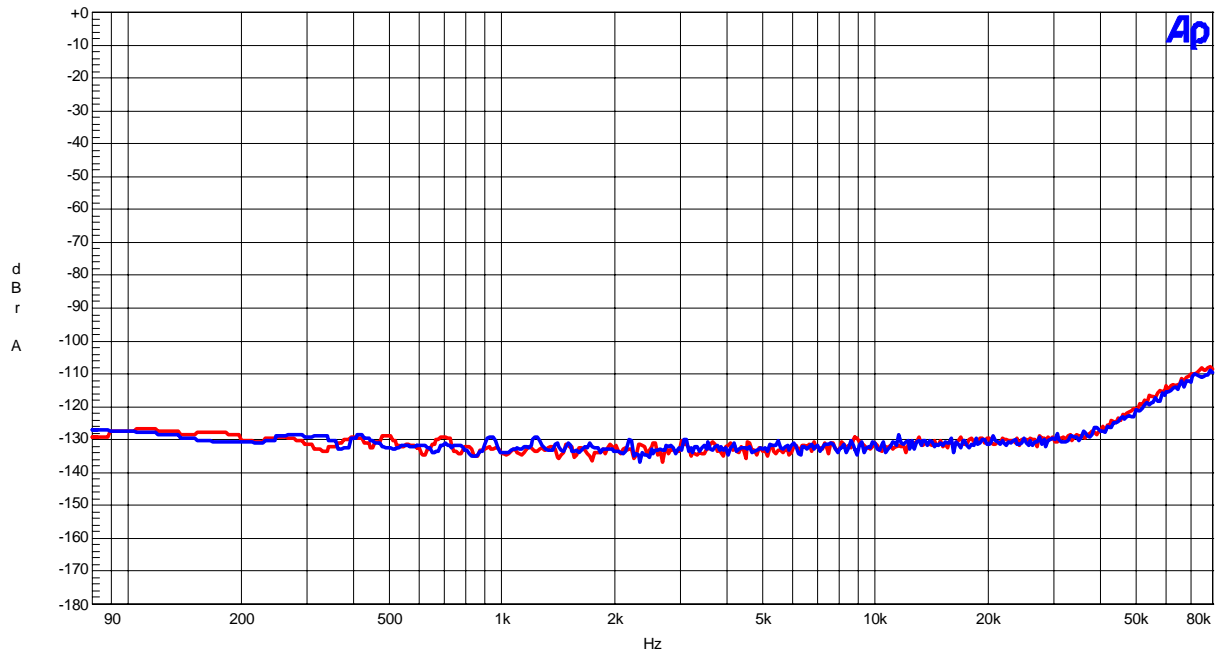

Figure 29. FFT (Noise Floor)

(fs=192kHz)

AKM

AK4385 THD+N vs. Input Level
VDD=5V, fs=192kHz, MCLK=128fs, fin=1kHz

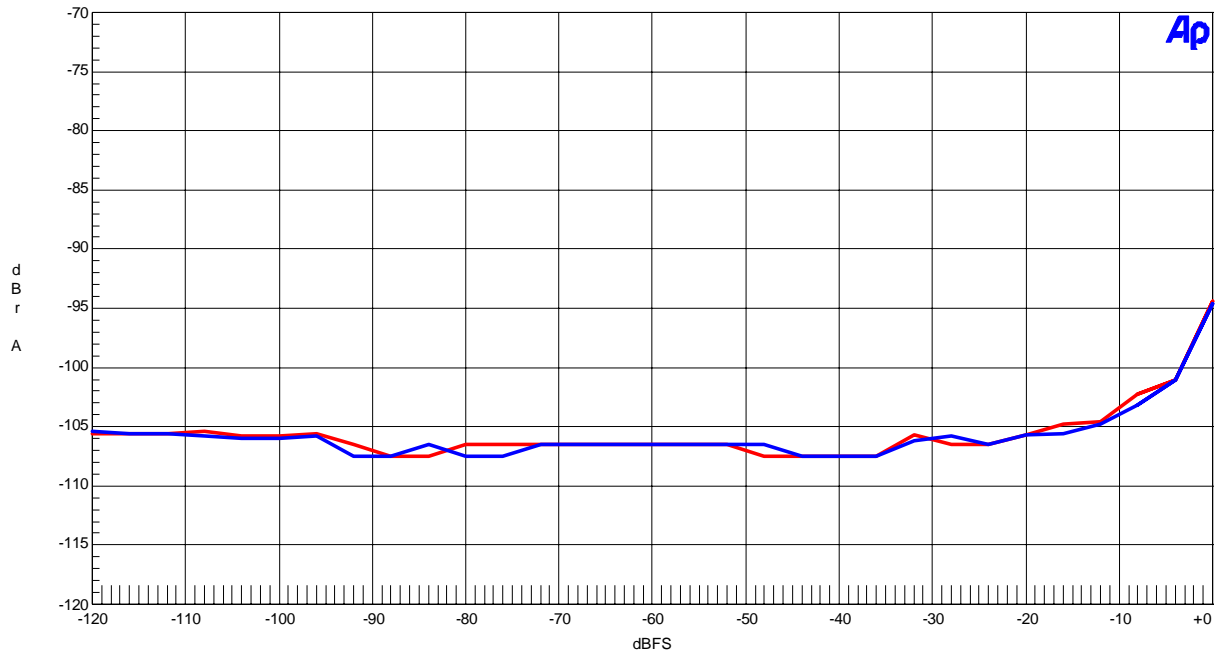

Figure 30. THD+N vs. Input level (fin=1kHz)

AKM

AK4385 THD+N vs. Input Frequency
VDD=5V, fs=192kHz, MCLK=128fs, 0dBFS input

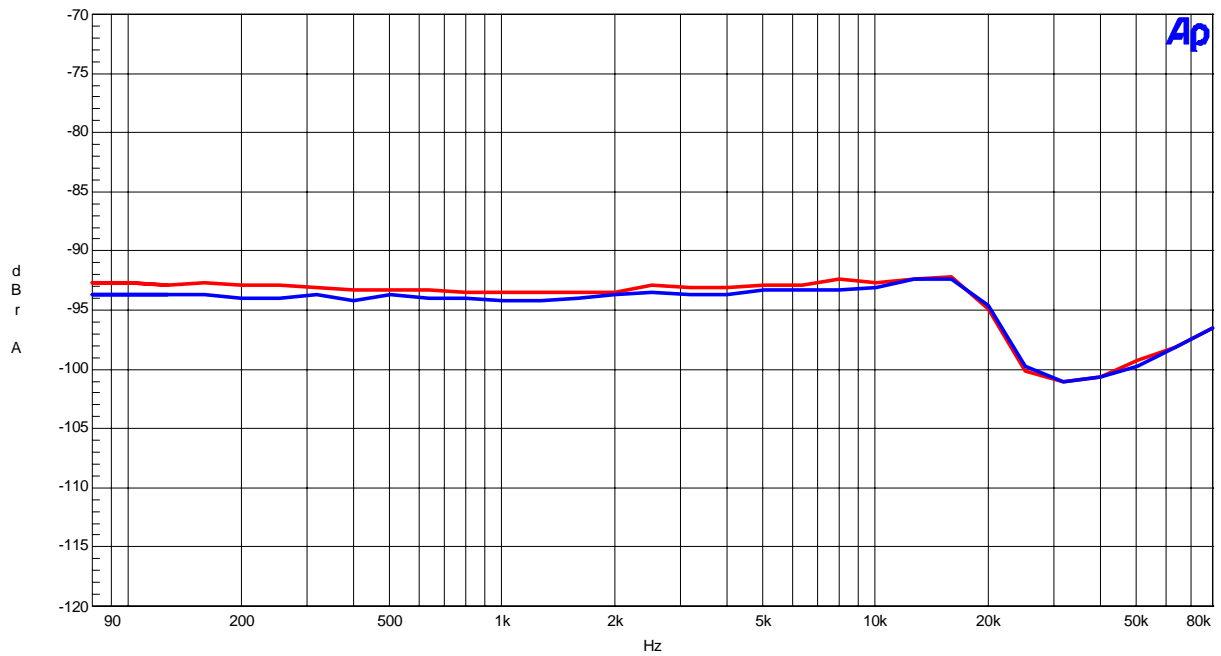

Figure 31. THD+N vs. Input Frequency (0dBFS input)

(fs=192kHz)

AKM

AK4385 Linearity
VDD=5V, fs=192kHz, MCLK=128fs, fin=1kHz

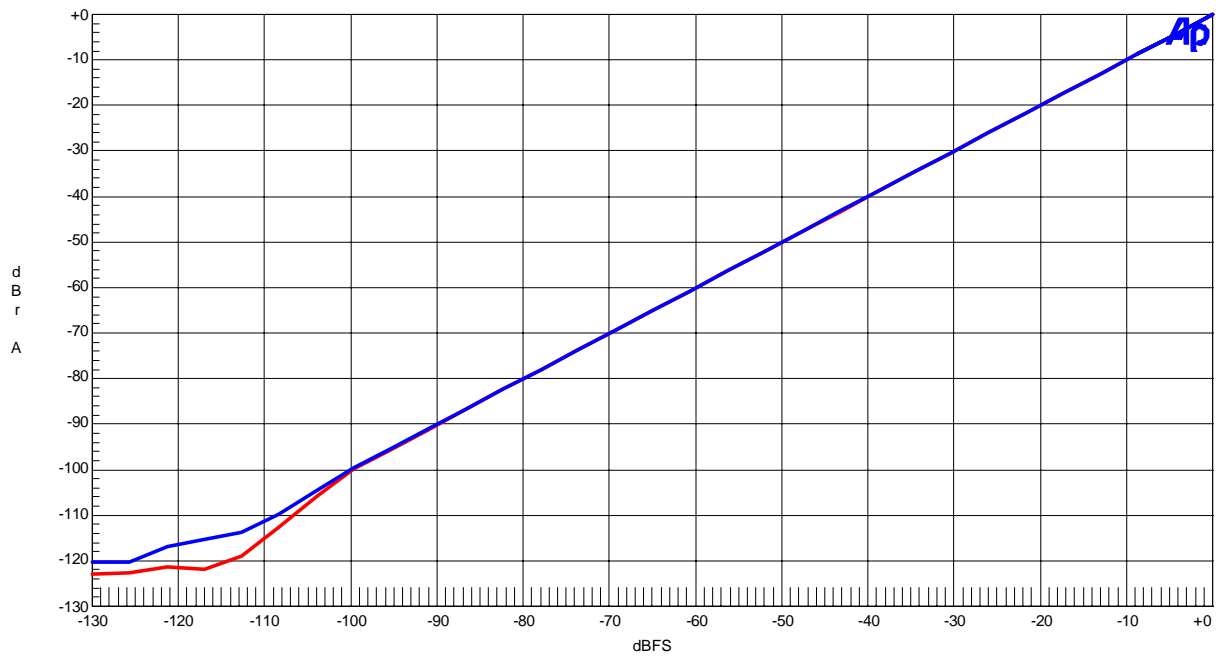

Figure 32. Linearity (fin=1kHz)

AKM

AK4385 Frequency Response
VDD=5V, fs=192kHz, MCLK=128fs, 0dBFS input

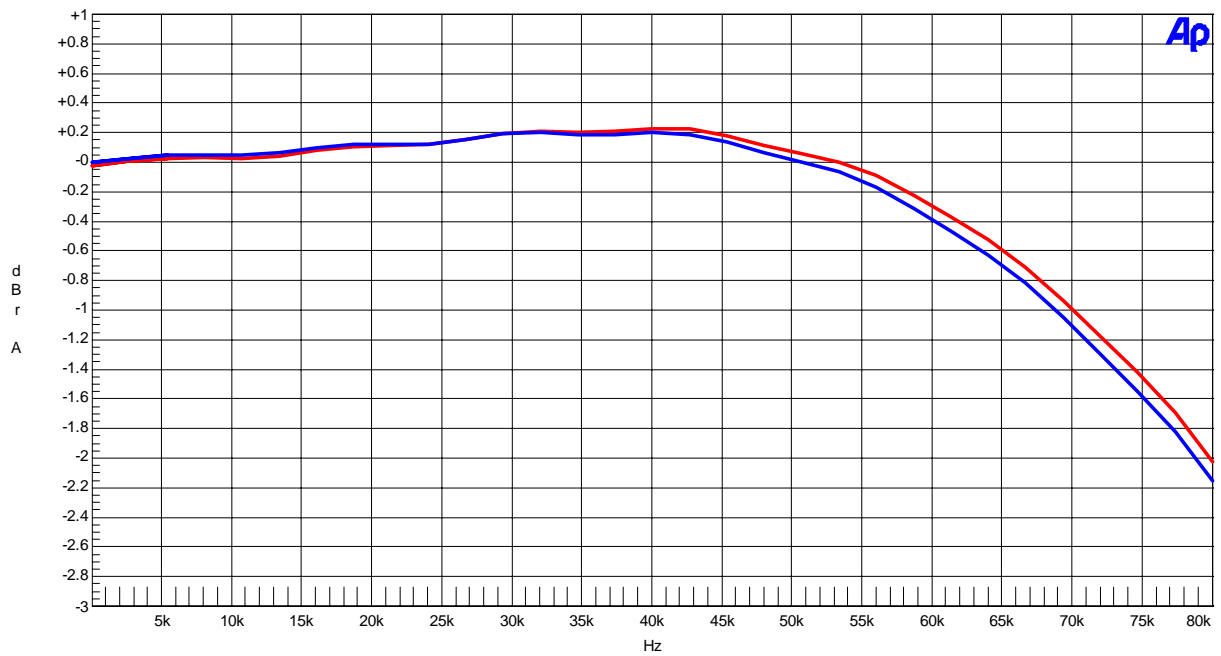

Figure 33. Frequency Response (0dBFS input)

(fs=192kHz)

AKM

AK4385 Crosstalk (Red=Lch, Blue=Rch)
VDD=5V, fs=192kHz, MCLK=128fs, 0dBFS input

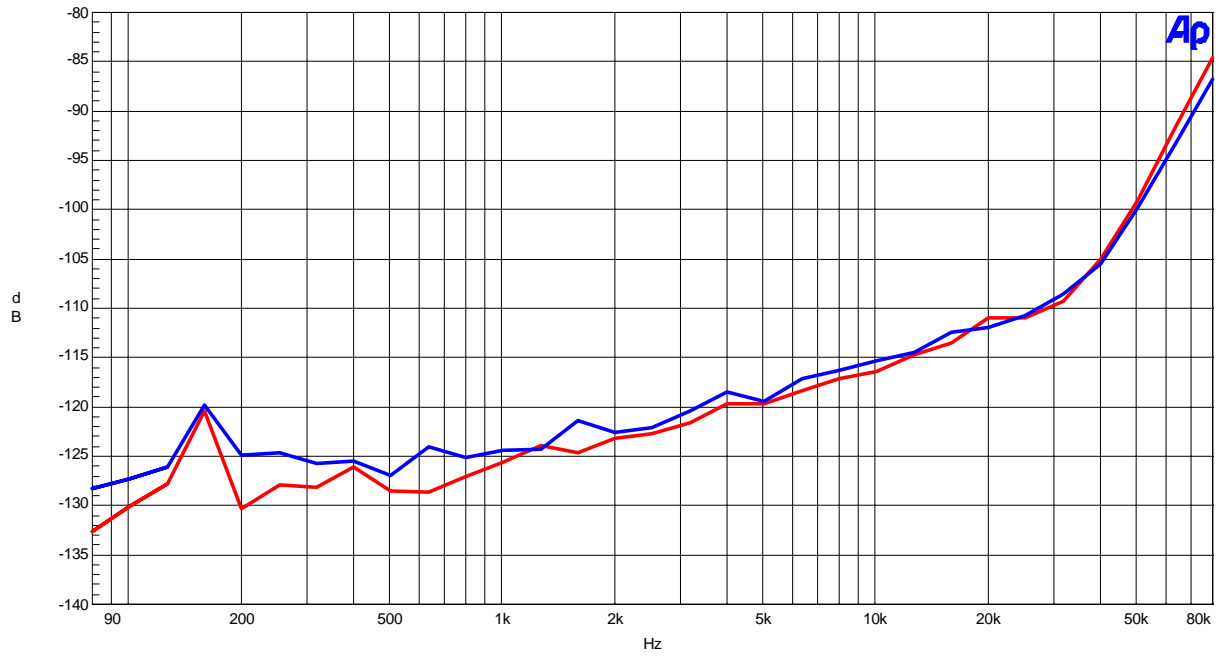

Figure 34. Crosstalk (0dBFS input)

Revision History

Date (YY/MM/DD)	Manual Revision	Board Revision	Reason	Contents
06/01/23	KM082700	0	First edition	
06/04/17	KM082701	1	Change	GND pattern change. P4 Change of calculation. $\omega_0 = \frac{1}{\sqrt{C_1 C_2 R_2 R_3}} \rightarrow \omega_0 = \frac{1}{\sqrt{2 C_1 C_2 R_2 R_3}}$
			Add	P12 fs=192kHz Table Data add. P13 – 27 Plot Data add.

IMPORTANT NOTICE

- These products and their specifications are subject to change without notice. Before considering any use or application, consult the Asahi Kasei Microsystems Co., Ltd. (AKM) sales office or authorized distributor concerning their current status.
- AKM assumes no liability for infringement of any patent, intellectual property, or other right in the application or use of any information contained herein.
- Any export of these products, or devices or systems containing them, may require an export license or other official approval under the law and regulations of the country of export pertaining to customs and tariffs, currency exchange, or strategic materials.
- AKM products are neither intended nor authorized for use as critical components in any safety, life support, or other hazard related device or system, and AKM assumes no responsibility relating to any such use, except with the express written consent of the Representative Director of AKM. As used here:
 - (a) A hazard related device or system is one designed or intended for life support or maintenance of safety or for applications in medicine, aerospace, nuclear energy, or other fields, in which its failure to function or perform may reasonably be expected to result in loss of life or in significant injury or damage to person or property.
 - (b) A critical component is one whose failure to function or perform may reasonably be expected to result, whether directly or indirectly, in the loss of the safety or effectiveness of the device or system containing it, and which must therefore meet very high standards of performance and reliability.
- It is the responsibility of the buyer or distributor of an AKM product who distributes, disposes of, or otherwise places the product with a third party to notify that party in advance of the above content and conditions, and the buyer or distributor agrees to assume any and all responsibility and liability for and hold AKM harmless from any and all claims arising from the use of said product in the absence of such notification.

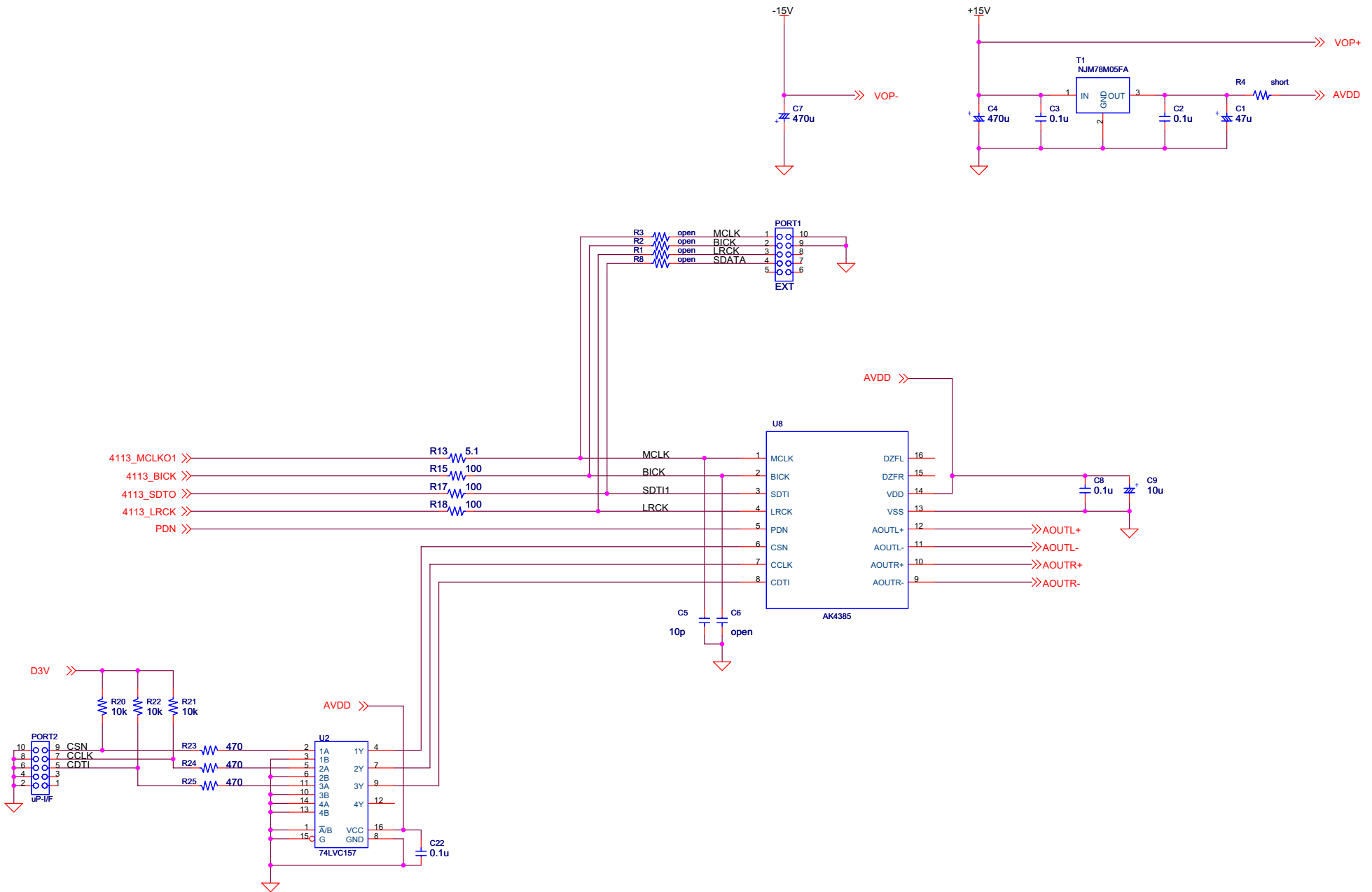

Title		
AKD4385-SC		
Size	Document Number	Rev
A3	AK4385	0
Date:	Thursday, January 12, 2006	Sheet 1 of 3

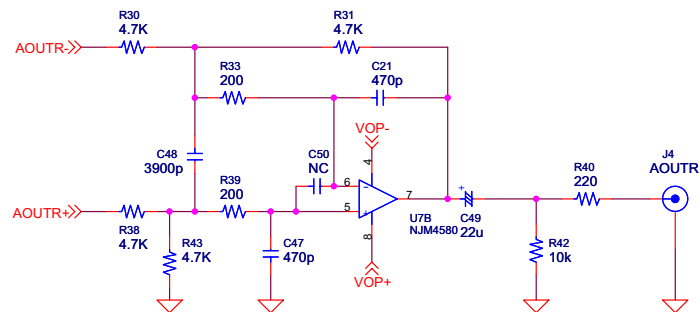
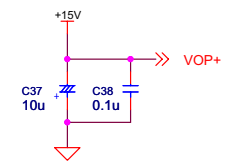
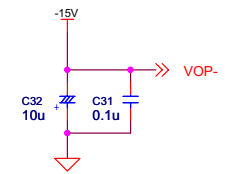
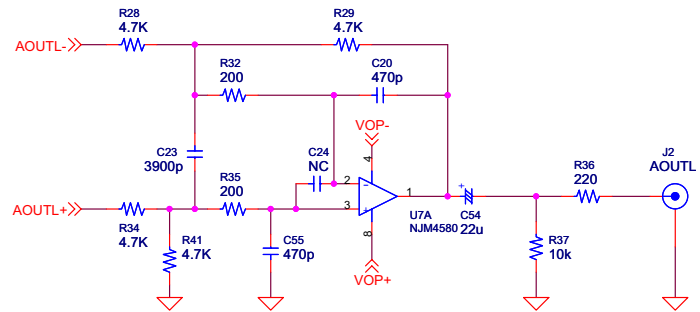

Title			
AKD4385-SC			
Size	Document Number	Analog	
A3			Rev 0
Date:	Thursday, January 12, 2006	Sheet	2 of 3

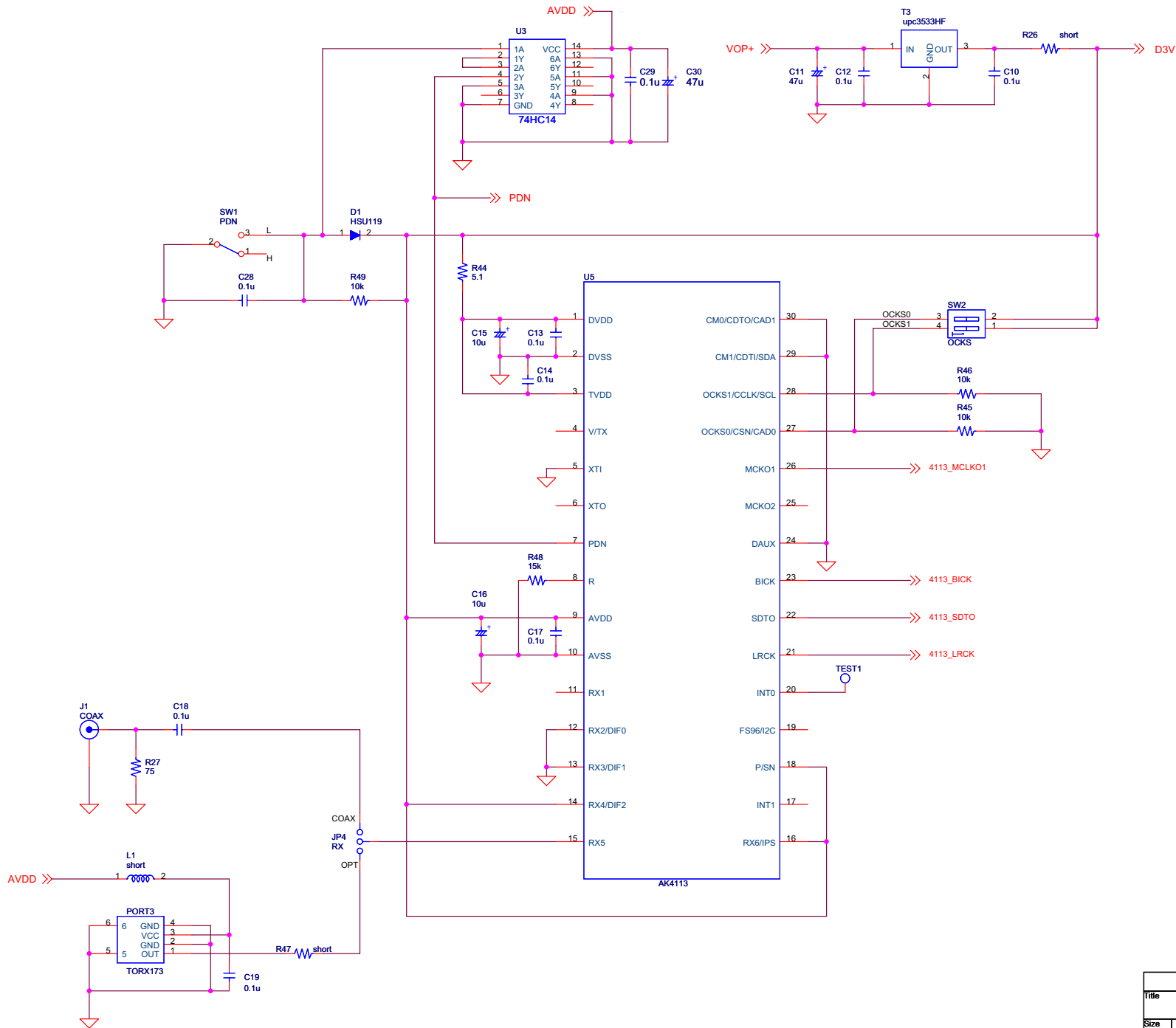

SW2

OCKS1	OCKS0	Master Clock
H	L	512fs@fs=32k/44.1k/48kHz
L	L	256fs@fs=88.2k/96kHz
H	H	128fs@fs=176.4k/192kHz

Title			AKD4385-SC		
Size	Document Number				Rev
A3	DIR				0
Date:	Thursday, January 12, 2006	Sheet	3	of	3