

**A Dimensions: [mm]**

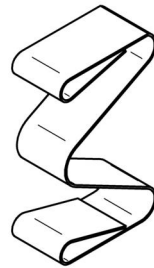

Scale - 3:1

**B Recommended land pattern: [mm]**

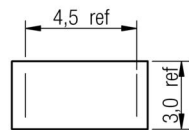
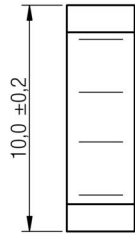
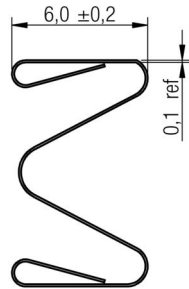
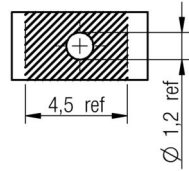
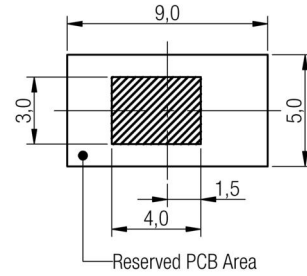

Scale - 3:1

**Recommended compression:**

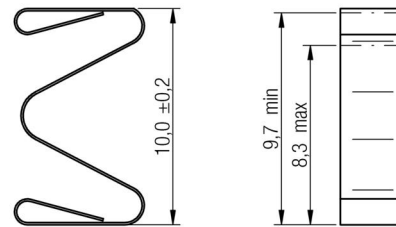

Scale - 3:1



**D Properties:**

Properties	Value
Material	Copper Beryllium (CuBe) gold-plated(AU)

**E General information:**

Storage Temperature: -40°C to 75°C  
 Operating Temperature: -20°C to 70°C

				Projection	DESCRIPTION			
					<b>WE-SECF SMD EMI Contact Finger</b>			
				Würth Elektronik eiSos GmbH & Co. KG EMC & Inductive Solutions Max-Eyth-Str. 1 74638 Waldenburg Germany Tel. +49 (0) 79 42 945 - 0 www.we-online.com eiSos@we-online.com		Order.- No.		SIZE
1.0	2012-10-30	SSt	WJ			<b>331061603010</b>		A4
REV	DATE	BY	CHECKED			Size: 0610		

### G Packaging Specification: [mm]

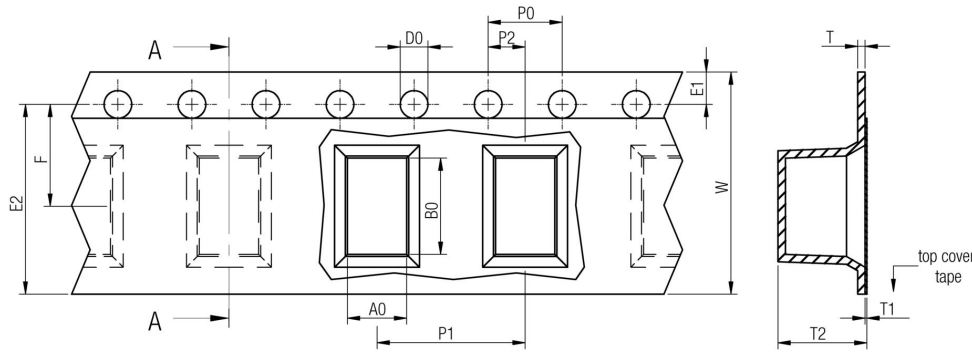

size	A0	B0	W	P1	T	T1	T2	D0	E1	E2	F	P0	P2	Tape	VPE / packaging unit
	typ.	typ.	± 0.3	± 0.1	± 0.1	max.	typ.	+0.1 -0.0	± 0.1	min.	± 0.05	± 0.1	± 0.05		
0148	2.20	4.70	16.00	8.00	0.40	0.10	7.20	1.50	1.75	14.25	7.50	4.00	2.00	Polystyrene	1500
0320	1.80	2.85	12.00	8.00	0.30	0.10	2.50	1.50	1.75	10.25	5.50	4.00	2.00	Polystyrene	3500
0315	1.70	3.30	12.00	8.00	0.30	0.10	2.10	1.50	1.75	10.25	5.50	4.00	2.00	Polystyrene	4500
0453	2.25	4.25	12.00	8.00	0.40	0.10	6.00	1.50	1.75	10.25	5.50	4.00	2.00	Polystyrene	1500
0557	2.20	4.90	12.00	8.00	0.40	0.10	6.30	1.50	1.75	10.25	5.50	4.00	2.00	Polystyrene	1500
0610	3.20	6.20	16.00	12.00	0.50	0.10	10.70	1.50	1.75	14.25	7.50	4.00	2.00	Polystyrene	500
0825	2.10	3.20	12.00	4.00	0.40	0.10	3.20	1.50	1.75	10.25	5.50	4.00	2.00	Polystyrene	5500
1440	2.75	3.75	12.00	8.00	0.35	0.10	4.65	1.50	1.75	10.25	5.50	4.00	2.00	Polystyrene	2000
1662	2.70	7.15	16.00	8.00	0.35	0.10	6.80	1.50	1.75	14.25	7.50	4.00	2.00	Polystyrene	1200
1670	2.20	4.70	16.00	8.00	0.40	0.10	7.60	1.50	1.75	14.25	7.50	4.00	2.00	Polystyrene	1000
1613	2.75	7.25	24.00	16.00	0.50	0.10	13.90	1.50	1.75	22.25	11.50	4.00	2.00	Polystyrene	200
1730	2.30	3.30	12.00	8.00	0.35	0.10	3.75	1.50	1.75	10.25	5.50	4.00	2.00	Polystyrene	2500
1735	2.20	3.20	12.00	8.00	0.35	0.10	4.60	1.50	1.75	10.25	5.50	4.00	2.00	Polystyrene	2000
2140	3.20	5.20	12.00	8.00	0.40	0.10	4.80	1.50	1.75	10.25	5.50	4.00	2.00	Polystyrene	2000
2240	2.10	6.10	16.00	8.00	0.40	0.10	4.60	1.50	1.75	14.25	7.50	4.00	2.00	Polystyrene	1800

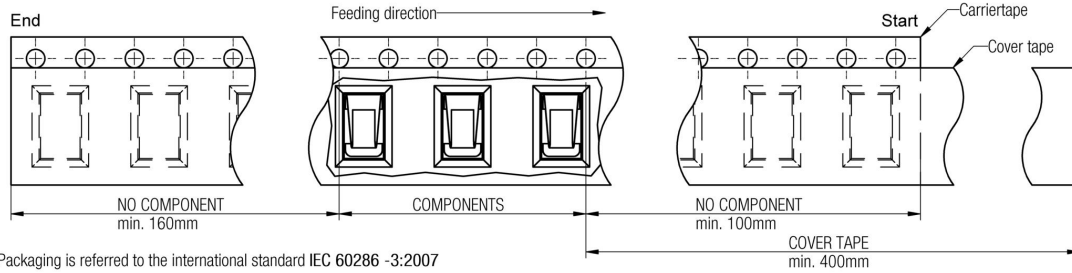

Packaging is referred to the international standard IEC 60286 - 3:2007

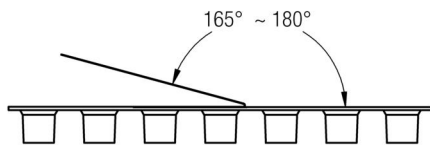

Tape width	Pull-of force	
	12 mm	16 mm
	0,1 N - 1,3 N	0,1 N - 1,3 N
	0,1 N - 1,3 N	0,1 N - 1,3 N

REV	DATE	BY	CHECKED
1.0	2012-10-30	SSt	WJ

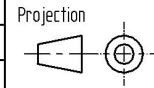

Würth Elektronik eiSos GmbH & Co. KG  
 EMC & Inductive Solutions  
 Max-Eyth-Str. 1  
 74638 Waldenburg  
 Germany  
 Tel. +49 (0) 79 42 945 - 0  
 www.we-online.com  
 eiSos@we-online.com

DESCRIPTION

### WE-SECF SMD EMI Contact Finger

Order.- No.

**331061603010**

Size: 0610



SIZE

A4

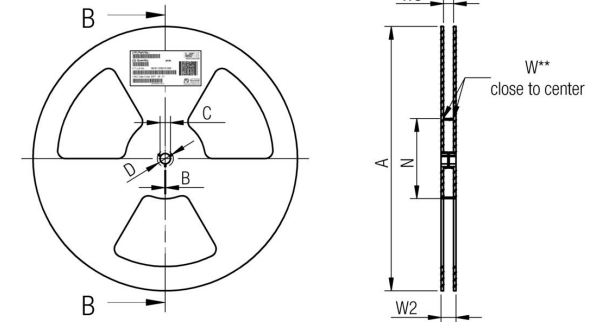

tolerance	A	B	C	D	N	W1	W2	W3	W3*	
	± 2.0	min.	± 0.8	min.	min.	+ 1.5	max.	min.	max.	
Tape width	12 mm	330,00	1,50	13,00	20,20	100,00	12,40	18,40	11,90	15,40
	16 mm	330,00	1,50	13,00	20,20	100,00	16,40	22,40	15,90	19,40
	24 mm	330,00	1,50	13,00	20,20	100,00	24,40	30,40	23,90	27,40

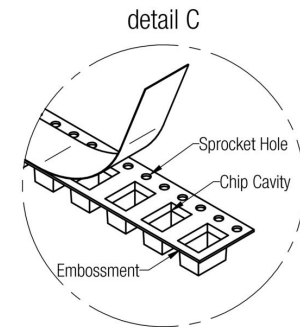
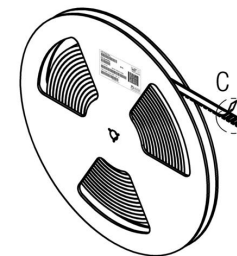

# H Soldering Specifications:



## H1: Classification Reflow Profile for SMT components:



## H2: Classification Reflow Profiles

Profile Feature	Pb-Free Assembly
Preheat - Temperature Min ( $T_{smin}$ ) - Temperature Max ( $T_{smax}$ ) - Time ( $t_s$ ) from ( $T_{smin}$ to $T_{smax}$ )	150°C 200°C 60-180 seconds
Ramp-up rate ( $T_L$ to $T_P$ )	3°C/ second max.
Liquidous temperature ( $T_L$ ) Time ( $t_L$ ) maintained above $T_L$	217°C 60-150 seconds
Peak package body temperature ( $T_P$ )	See Table H3
Time within 5°C of actual peak temperature ( $t_p$ )	20-30 seconds
Ramp-down rate ( $T_P$ to $T_L$ )	6°C/ second max.
Time 25°C to peak temperature	8 minutes max.

refer to IPC/JEDEC J-STD-020D

## H3: Package Classification Reflow Temperature

	Package Thickness	Volume mm <sup>3</sup> <350	Volume mm <sup>3</sup> 350 - 2000	Volume mm <sup>3</sup> >2000
<b>PB-Free Assembly</b>	< 1.6 mm	260°C	260°C	260°C
<b>PB-Free Assembly</b>	1.6 - 2.5 mm	260°C	250°C	245°C
<b>PB-Free Assembly</b>	≥ 2.5 mm	250°C	245°C	245°C

refer to IPC/JEDEC J-STD-020D

				Projection 	DESCRIPTION
					<b>WE-SECF SMD EMI Contact Finger</b>
				Würth Elektronik eiSos GmbH & Co. KG EMC & Inductive Solutions Max-Eyth-Str. 1 74638 Waldenburg Germany Tel. +49 (0) 79 42 945 - 0 www.we-online.com eiSos@we-online.com	Order.- No. <b>331061603010</b> Size: 0610
1.0	2012-10-30	SSt	WJ		COMPLIANT RoHS&REACH WÜRTH ELEKTRONIK
REV	DATE	BY	CHECKED		SIZE A4

This electronic component has been designed and developed for usage in general electronic equipment only. This product is not authorized for use in equipment where a higher safety standard and reliability standard is especially required or where a failure of the product is reasonably expected to cause severe personal injury or death, unless the parties have executed an agreement specifically governing such use. Moreover Würth Elektronik eiSos GmbH & Co KG products are neither designed nor intended for use in areas such as military, aerospace, aviation, nuclear control, submarine, transportation (automotive control, train control, ship control), transportation signal, disaster prevention, medical, public information network etc.. Würth Elektronik eiSos GmbH & Co KG must be informed about the intent of such usage before the design-in stage. In addition, sufficient reliability evaluation checks for safety must be performed on every electronic component which is used in electrical circuits that require high safety and reliability functions or performance.

## I Cautions and Warnings:

The following conditions apply to all goods within the product series of **WE-SECF** of Würth Elektronik eiSos GmbH & Co. KG:

### General:

All recommendations according to the general technical specifications of the data sheet have to be complied with.



The responsibility for the applicability of customer specific products and use in a particular customer design is always within the authority of the customer. All technical specifications for standard products do also apply for customer specific products.

### Product specific:

Follow all instructions mentioned in the datasheet, especially:

- The solder profile has to be complied with according to the technical reflow soldering specification, otherwise no warranty will be sustained.
- To avoid contact finger misplacement and the coming off the soldering joints use maximum adjusted force at the Pick- and Place machine that does not exceed the recommended compression rate (of the contact fingers).
- The soldering joints must be kept clean, dry and grease free. The contact finger should be placed onto the solder pad of the printed circuit board in a way that no tin- solder is able to come into the undermost or the first elastic bending of the contact fingers so that the bending will not be affected.
- The contact finger shall not exceed the recommended compression rate. If recommended compression rate is exceeded there is a risk that the spring will not be able to push back into the initial state.
- Do not bend the contact finger into the opposite position, as the material will overstretch and possibly break.
- Violation of the technical product specifications will result in the loss of warranty.

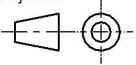

				Projection 		DESCRIPTION
						<b>WE-SECF SMD EMI Contact Finger</b>
				Würth Elektronik eiSos GmbH & Co. KG EMC & Inductive Solutions Max-Eyth-Str. 1 74638 Waldenburg Germany Tel. +49 (0) 79 42 945 - 0 www.we-online.com eiSos@we-online.com		Order.- No. <b>331061603010</b> Size: 0610
1.0	2012-10-30	SSt	WJ			
REV	DATE	BY	CHECKED			SIZE A4

## J Important Notes:

The following conditions apply to all goods within the product range of Würth Elektronik eiSos GmbH & Co. KG:



### 1. General Customer Responsibility

Some goods within the product range of Würth Elektronik eiSos GmbH & Co. KG contain statements regarding general suitability for certain application areas. These statements about suitability are based on our knowledge and experience of typical requirements concerning the areas, serve as general guidance and cannot be estimated as binding statements about the suitability for a customer application. The responsibility for the applicability and use in a particular customer design is always solely within the authority of the customer. Due to this fact it is up to the customer to evaluate, where appropriate to investigate and decide whether the device with the specific product characteristics described in the product specification is valid and suitable for the respective customer application or not.

### 2. Customer Responsibility related to Specific, in particular Safety-Relevant Applications

It has to be clearly pointed out that the possibility of a malfunction of electronic components or failure before the end of the usual lifetime cannot be completely eliminated in the current state of the art, even if the products are operated within the range of the specifications.

In certain customer applications requiring a very high level of safety and especially in customer applications in which the malfunction or failure of an electronic component could endanger human life or health it must be ensured by most advanced technological aid of suitable design of the customer application that no injury or damage is caused to third parties in the event of malfunction or failure of an electronic component.

### 3. Best Care and Attention

Any product-specific notes, cautions and warnings must be strictly observed. Any disregard will result in the loss of warranty.

### 4. Customer Support for Product Specifications

Some products within the product range may contain substances which are subject to restrictions in certain jurisdictions in order to serve specific technical requirements. Necessary information is available on request. In this case the field sales engineer or the internal sales person in charge should be contacted who will be happy to support in this matter.

### 5. Product R&D

Due to constant product improvement product specifications may change from time to time. As a standard reporting procedure of the Product Change Notification (PCN) according to the JEDEC-Standard inform about minor and major changes. In case of further queries regarding the PCN, the field sales engineer or the internal sales person in charge should be contacted. The basic responsibility of the customer as per Section 1 and 2 remains unaffected.

### 6. Product Life Cycle

Due to technical progress and economical evaluation we also reserve the right to discontinue production and delivery of products. As a standard reporting procedure of the Product Termination Notification (PTN) according to the JEDEC-Standard we will inform at an early stage about inevitable product discontinuance. According to this we cannot guarantee that all products within our product range will always be available. Therefore it needs to be verified with the field sales engineer or the internal sales person in charge about the current product availability expectancy before or when the product for application design-in disposal is considered.



The approach named above does not apply in the case of individual agreements deviating from the foregoing for customer-specific products.

### 7. Property Rights

All the rights for contractual products produced by Würth Elektronik eiSos GmbH & Co. KG on the basis of ideas, development contracts as well as models or templates that are subject to copyright, patent or commercial protection supplied to the customer will remain with Würth Elektronik eiSos GmbH & Co. KG.

### 8. General Terms and Conditions

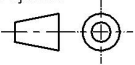
Unless otherwise agreed in individual contracts, all orders are subject to the current version of the "General Terms and Conditions of Würth Elektronik eiSos Group", last version available at [www.we-online.com](http://www.we-online.com).

				Projection 	DESCRIPTION
					<b>WE-SECF SMD EMI Contact Finger</b>
				Würth Elektronik eiSos GmbH & Co. KG EMC & Inductive Solutions Max-Eyth-Str. 1 74638 Waldenburg Germany Tel. +49 (0) 79 42 945 - 0 <a href="http://www.we-online.com">www.we-online.com</a> <a href="mailto:eiSos@we-online.com">eiSos@we-online.com</a>	Order.- No. <b>331061603010</b> Size: 0610
1.0	2012-10-30	SSt	WJ		
REV	DATE	BY	CHECKED		SIZE A4