

## POWER SCHOTTKY RECTIFIER

### MAIN PRODUCT CHARACTERISTICS

<b>I<sub>F(AV)</sub></b>	<b>2 x 40 A</b>
<b>V<sub>RRM</sub></b>	<b>60 V</b>
<b>T<sub>j (max)</sub></b>	<b>150 °C</b>
<b>V<sub>F (max)</sub></b>	<b>0.56 V</b>

### FEATURES AND BENEFITS

- VERY SMALL CONDUCTION LOSSES
- NEGLIGIBLE SWITCHING LOSSES
- EXTREMELY FAST SWITCHING
- LOW FORWARD VOLTAGE DROP
- LOW THERMAL RESISTANCE

### DESCRIPTION

Dual center tap Schottky rectifier suited for CAD computers and servers.

Packaged in Max247, STPS80L60CY is intended for use in low voltage, high frequency switching power supplies, free wheeling and polarity protection applications.

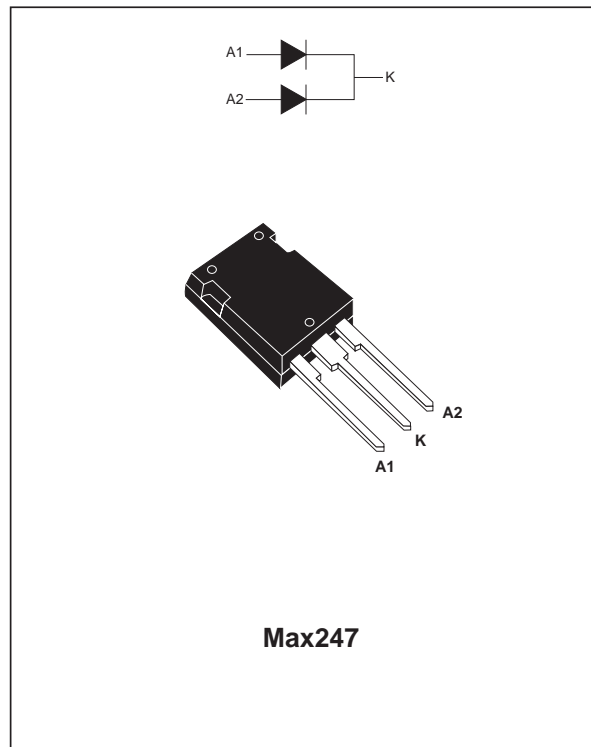

### ABSOLUTE RATINGS (limiting values, per diode)

Symbol	Parameter		Value	Unit	
V <sub>RRM</sub>	Repetitive peak reverse voltage		60	V	
I <sub>F(RMS)</sub>	RMS forward current		56	A	
I <sub>F(AV)</sub>	Average forward current	T <sub>c</sub> = 130°C	Per diode	40	A
		δ = 0.5	Per device	80	
I <sub>FSM</sub>	Surge non repetitive forward current	tp = 10 ms sinusoidal	400	A	
I <sub>RRM</sub>	Repetitive peak reverse current	tp = 2 μs square F = 1kHz	2	A	
T <sub>stg</sub>	Storage temperature range		- 55 to + 150	°C	
T <sub>j</sub>	Maximum operating junction temperature *		150	°C	
dV/dt	Critical rate of rise of reverse voltage		10000	V/μs	

\* :  $\frac{dP_{tot}}{dT_j} < \frac{1}{R_{th}(j-a)}$  thermal runaway condition for a diode on its own heatsink

# STPS80L60CY

## THERMAL RESISTANCES

Symbol	Parameter		Value	Unit
R <sub>th(j-c)</sub>	Junction to case	Per diode	0.70	°C/W
		Total	0.50	
R <sub>th(c)</sub>		Coupling	0.3	

When the diodes 1 and 2 are used simultaneously :  
 $\Delta T_j(\text{diode 1}) = P(\text{diode 1}) \times R_{th(j-c)}(\text{Per diode}) + P(\text{diode 2}) \times R_{th(c)}$

## STATIC ELECTRICAL CHARACTERISTICS (per diode)

Symbol	Parameter	Tests conditions		Min.	Typ.	Max.	Unit
I <sub>R</sub> *	Reverse leakage current	T <sub>j</sub> = 25°C	V <sub>R</sub> = V <sub>RRM</sub>			1.8	mA
		T <sub>j</sub> = 125°C			0.4	0.9	
V <sub>F</sub> *	Forward voltage drop	T <sub>j</sub> = 25°C	I <sub>F</sub> = 40 A			0.57	V
		T <sub>j</sub> = 125°C			0.50	0.56	
		T <sub>j</sub> = 25°C	I <sub>F</sub> = 80 A			0.78	
		T <sub>j</sub> = 125°C			0.69	0.77	

Pulse test : \* t<sub>p</sub> = 380 μs, δ < 2%

To evaluate the maximum conduction losses use the following equation :  
 $P = 0.36 \times I_{F(AV)} + 0.005 \times I_{F(RMS)}^2$

Fig. 1: Conduction losses versus average current.

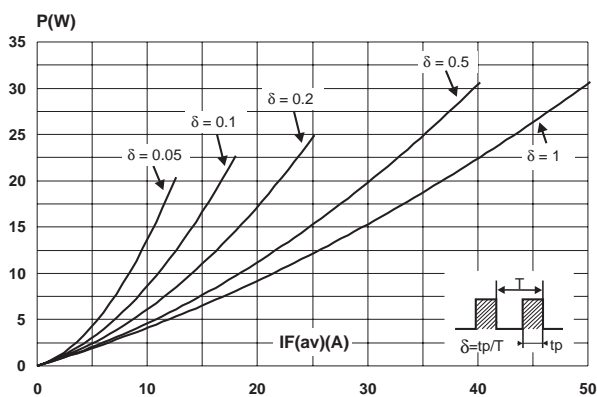
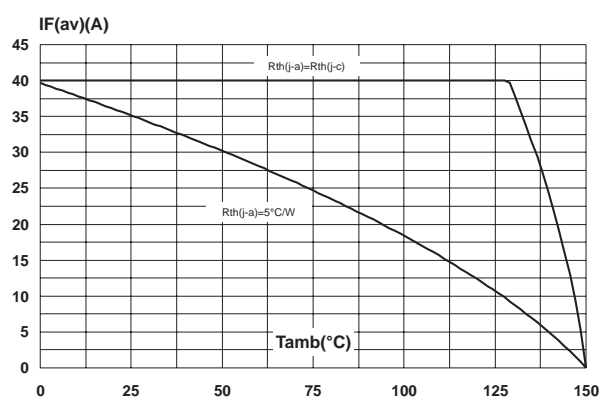
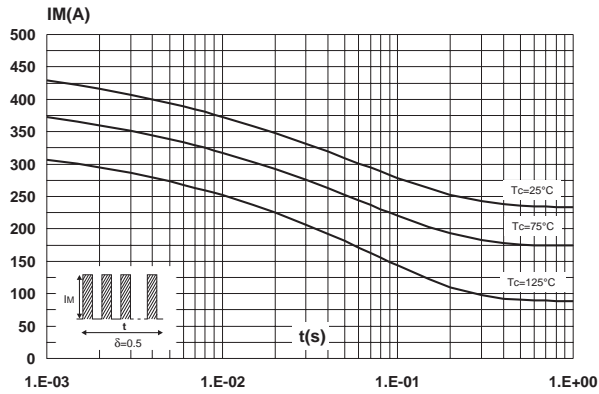

Fig. 2: Average forward current versus ambient temperature (δ = 0.5).



**Fig. 3:** Non repetitive surge peak forward current versus overload duration (maximum values).



**Fig. 4:** Relative variation of thermal impedance junction to case versus pulse duration.

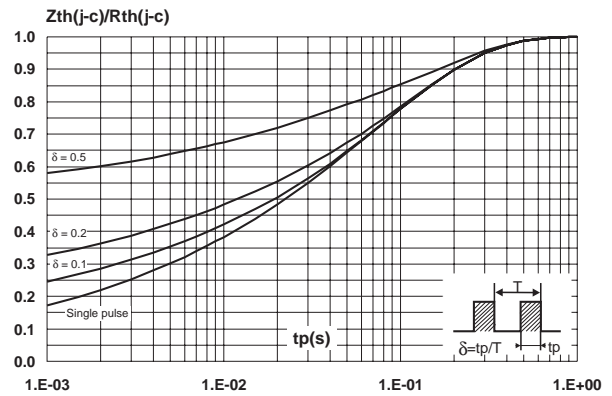

**Fig. 5:** Reverse leakage current versus reverse voltage applied (typical values).

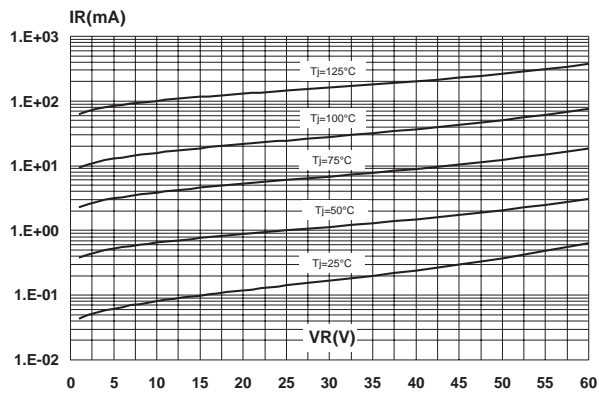

**Fig. 6:** Junction capacitance versus reverse voltage applied (typical values).

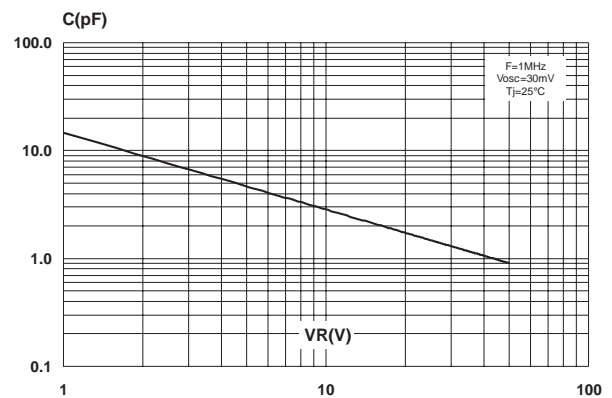

**Fig. 7:** Forward voltage drop versus forward current.

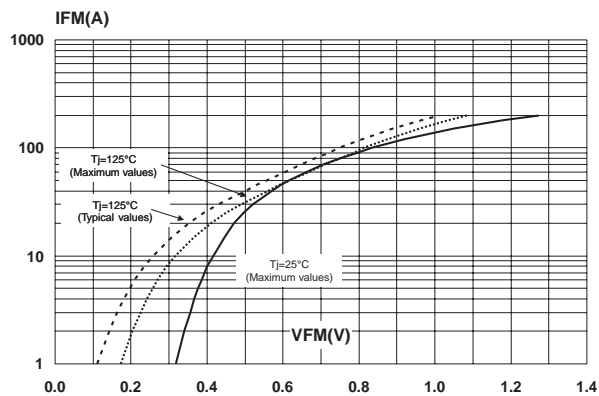

# STPS80L60CY

## PACKAGE MECHANICAL DATA

Max247

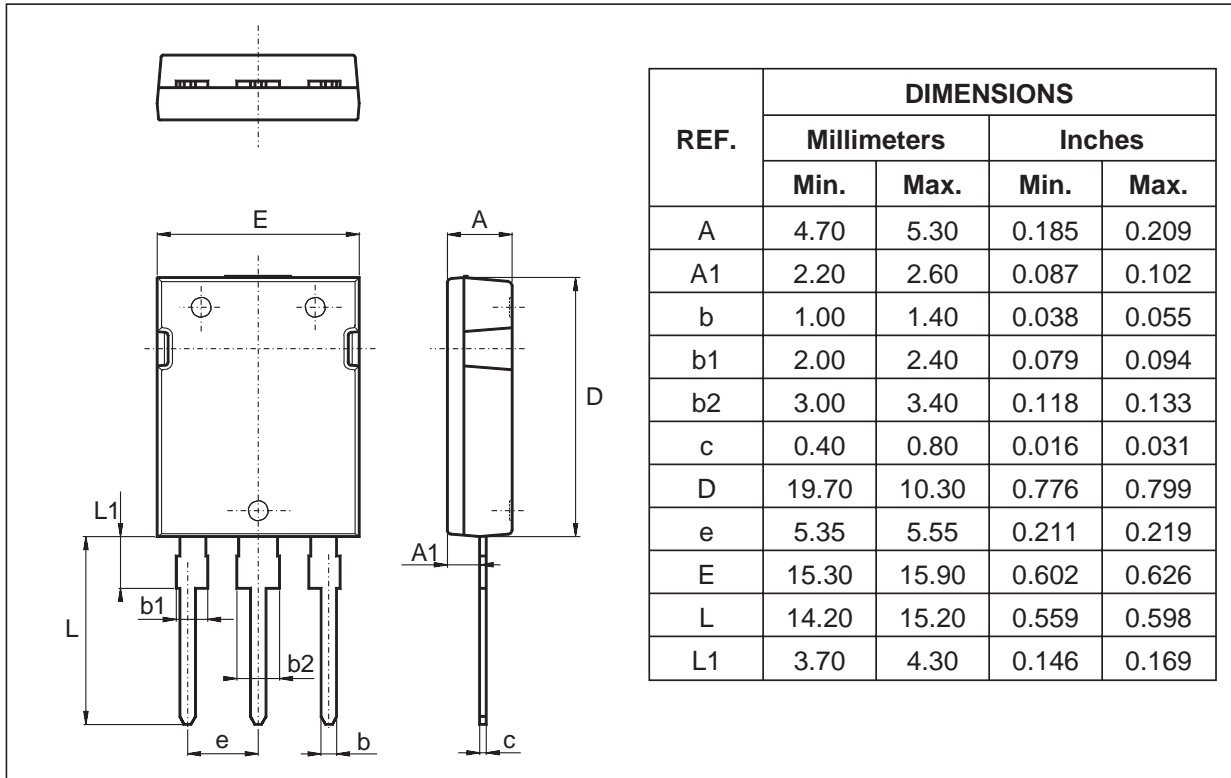

Ordering type	Marking	Package	Weight	Base qty	Delivery mode
STPS80L60CY	STPS80L60CY	Max247	4.4g	30	Tube

- Epoxy meets UL94,V0

Information furnished is believed to be accurate and reliable. However, STMicroelectronics assumes no responsibility for the consequences of use of such information nor for any infringement of patents or other rights of third parties which may result from its use. No license is granted by implication or otherwise under any patent or patent rights of STMicroelectronics. Specifications mentioned in this publication are subject to change without notice. This publication supersedes and replaces all information previously supplied. STMicroelectronics products are not authorized for use as critical components in life support devices or systems without express written approval of STMicroelectronics.

The ST logo is a registered trademark of STMicroelectronics

© 2001 STMicroelectronics - Printed in Italy - All rights reserved.

STMicroelectronics GROUP OF COMPANIES

Australia - Brazil - China - Finland - France - Germany - Hong Kong - India - Italy - Japan - Malaysia  
 Malta - Morocco - Singapore - Spain - Sweden - Switzerland - United Kingdom - U.S.A.

<http://www.st.com>