

EVALUATION KIT
AVAILABLE

System Power Management for Mobile Handset

MAX8939

General Description

The MAX8939 power management IC contains the necessary supplies and features for supporting cell phone designs based on the Intel Mobile Communications (IMC) 61XX 3G platform. Designed to power all peripheral components in the platform, the MAX8939 also provides the necessary signals to control the 61XX baseband processor.

The integrated lithium-ion (Li+) charger is protected up to 28V input and features a protected output voltage for supply of a USB transceiver. Proprietary thermal-regulation circuitry limits the die temperature during fast-charging or when the IC is exposed to high ambient temperatures, allowing maximum charging current without damaging the IC. A dedicated current regulator is included for driving a charge indicator LED.

Four programmable low-noise, low-dropout linear regulators (LDOs) provide the supply for noise sensitive peripherals. A high power vibrator driver is I²C programmable in 70 PWM levels and 4 output voltages. The MAX8939 also offers two step-up converters; one high power, low voltage (5V) to supply an external audio amplifier or camera flash, and a high voltage (28V) supply for the display and keyboard backlight. Two integrated 25mA current regulators provide independent ramp-up and ramp-down control, programmable through I²C.

The MAX8939 is a highly integrated IC that requires very few external components and is available in a compact 2.5mm x 3.0mm, 0.65mm max height wafer level package (WLP).

Applications

Companion Chip for Cell Phones/Smartphones

Features

- ◆ **Step-Up Converter**
 - 700mA Guaranteed Output Current
 - I²C Programmable Output 3.5V to 5.0V in 16 Steps
 - Over 90% Efficiency
 - On-Chip FET and Synchronous Rectifier
 - Fixed 2MHz PWM Switching
 - Small 2.2μH to 10μH Inductor
- ◆ **WLED Boost Converter**
 - 28V Max Step-Up Output Voltage
 - 60mA Output Current
 - Integrated nMOS Power Switch
 - Over 90% Efficiency
 - Fixed 2MHz Switching
 - Small 4.7μH to 10μH Inductor

Two 25mA Individually Programmable Current Regulators
I²C Programmable Output Current (50μA to 25.25mA) with 128-Step Pseudo Log Dimming
Individually Programmable Ramp (Up/Down) Timers
Low Dropout (150mV max)

- ◆ **Linear One-Cell Li+ Battery Charger**
 - No External MOSFET, Reverse Blocking Diode, or Current-Sense Resistor
 - Programmable Fast-Charge Current (1.5A_{RMS} max)
 - Programmable Top-Off Current Threshold
 - Proprietary Die Temperature Regulation Control
 - 4.1V to 10V Input Voltage Range with Input Overvoltage Protection Up to 28V
 - Low-Dropout Voltage (300mV at 500mA)
 - Input Power-Source Detection Output
 - Input Overvoltage Protected 4.75V Output (SAFE_OUT) from IN
 - Charge Current Monitor Output
 - Indicator LED
 - Hardware Input Enable
 - 5s Watchdog Feature During Charge
- ◆ **Four Low-Noise LDOs**
 - 1x 400mA, 2 x 200mA and 1x 100mA Output Current
 - High 65dB (typ) PSRR
 - Low Noise (45μV_{RMS} typ)
 - 1.7V to 3.2V Programmable Output Voltage
 - Low Quiescent Current (25μA typ)
 - 400mA LDO with Hardware Enable Input
- ◆ **Vibrator Driver**
 - Guaranteed 200mA Output Current
 - Programmable Output Voltage 1.3V to V_{IN}V_{IB}
 - Repetition Frequency 23.8kHz
 - PWM Speed Control in 70 steps
 - Active Stop Brake
- ◆ **Control Interface for 61XX Baseband**
 - MAX8939 Control Through I²C
 - RESET_IN Reset Input
 - Charger Detect PWR_ON_CMP Output
 - IRQ Interrupt Output
- ◆ 2.7V to 5.5V Supply Voltage Range
- ◆ Thermal Shutdown

Ordering Information

PART	TEMP RANGE	PIN-PACKAGE
MAX8939EWW+T	-40°C to +85°C	30 WLP (0.5mm pitch)

+Denotes a lead(Pb)-free/RoHS-compliant package.

T = Tape and reel.

Typical Operating Circuit appears at end of data sheet.



System Power Management for Mobile Handset

ABSOLUTE MAXIMUM RATINGS

BATT, OUT1, SAFE_OUT, and INVIB to AGND-0.3V to +6.0V
 CHG_IN, OUT2, LED1, and LED2 to AGND.....-0.3V to +30V
 LED3 and CHG_MON to AGND....-0.3V to (VSAFE_OUT + 0.3V)
 COMP2, IRQ, RESET_IN, COMP1, SCL, SDA, CHG,
 PWR_ON_CMP, REF, LDO1, LDO2, LDO3, LDO4,
 and LDO1_EN to AGND.....-0.3V to (VBATT + 0.3V)
 OUTVIB to AGND.....-0.3V to (VINVIB + 0.3V)
 PGND1 and PGND2 to AGND-0.3V to +0.3V
 LX1, LX2 Current (Note 1)..... 1.7ARMS

Continuous Power Dissipation (TA = +70°C)
 WLP (derate 24.4mW/°C above +70°C)..... 1.9W
 Junction to Ambient Thermal Resistance (θJA)
 (Note 2).....41°C/W
 Operating Temperature.....-40°C to +85°C
 Junction Temperature+150°C
 Storage Temperature Range.....-65°C to +150°C
 Soldering Temperature (reflow)+260°C

Note 1: LX1 has internal clamp diodes to PGND1 and OUT1. LX2 has internal clamp diodes to PGND2 and OUT2. Applications that forward bias these diodes should take care not to exceed the IC package power dissipation limit.

Note 2: Package thermal resistances were obtained using the method described in JEDEC specification JESD51-7, using a four-layer board. For detailed information on package thermal considerations, refer to <http://www.maxim-ic.com/thermal-tutorial>.

Stresses beyond those listed under "Absolute Maximum Ratings" may cause permanent damage to the device. These are stress ratings only, and functional operation of the device at these or any other conditions beyond those indicated in the operational sections of the specifications is not implied. Exposure to absolute maximum rating conditions for extended periods may affect device reliability.

ELECTRICAL CHARACTERISTICS

(VBATT = 3.7V, VCHG_IN = 5.0V, circuit of Figure 1, TA = -40°C to +85°C, unless otherwise noted. Typical values are at TA = +25°C.)

PARAMETER	CONDITIONS	MIN	TYP	MAX	UNITS
BATT					
BATT Operating Voltage		2.9		5.5	V
BATT Shutdown Supply Current	All outputs off, I ² C disabled, VSCL = VSDA = VRESET_IN = 0V		0.4	1	μA
			0.4		
BATT Standby Supply Current	All outputs off, VSCL = VSDA = VRESET_IN = 1.8V, I ² C ready		5	10	μA
			5		
BATT Biasing Supply Current	I ² C ready, one or more outputs on		60		μA
Undervoltage Lockout (UVLO) Threshold	BATT rising	2.6	2.75	2.9	V
Undervoltage Lockout Hysteresis			100		mV
THERMAL SHUTDOWN					
Threshold			+160		°C
Hysteresis			20		°C
REFERENCE					
Reference Output Voltage			1.200		V
Reference Supply Rejection			0.2		mV
LOGIC AND CONTROL INPUTS					
Input Low Level	SDA, SCL, LDO1_EN, CHG, and RESET_IN			0.4	V
Input High Level	SDA, SCL, LDO1_EN, CHG, and RESET_IN	1.40			V
Logic-Input Current	SDA, SCL, LDO1_EN, CHG, and RESET_IN, 0 < VIN < 5.5V	TA = +25°C	-1	+1	μA
		TA = +85°C		0.1	

System Power Management for Mobile Handset

MAX8939

ELECTRICAL CHARACTERISTICS (continued)

(VBATT = 3.7V, VCHG_IN = 5.0V, circuit of Figure 1, TA = -40°C to +85°C, unless otherwise noted. Typical values are at TA = +25°C.)

PARAMETER	CONDITIONS	MIN	TYP	MAX	UNITS
LOGIC AND CONTROL OUTPUTS					
IRQ (Open-Drain Output) Output Low Voltage	IIRQ = 2mA			0.4	V
PWR_ON_CMP (Open-Drain Output) Output Low Voltage	IPWR_ON_CMP = 2mA			0.4	V
SDA Output Low Level	ISDA = 6mA			0.4	V
I²C SERIAL INTERFACE (VSCL = VSDA = 3V) (Figure 15)					
Clock Frequency				400	kHz
Bus-Free Time Between START and STOP	tBUF	1.3			μs
Hold Time Repeated START Condition	tHD_STA	0.6			μs
SCL Low Period	tLOW	1.3			μs
SCL High Period	tHIGH	0.6			μs
Setup Time Repeated START Condition	tSU_STA	0.6			μs
SDA Hold Time	tHD_DAT	0			μs
SDA Setup time	tSU_DAT	100			ns
Maximum Pulse Width of Spikes that Must Be Suppressed by the Input Filter of Both DATA and CLK Signals			50		ns
Setup Time for STOP Condition	tSU_STO	0.6			μs
CHG_IN					
Input Operating Range		4.1		10	V
CHG_IN Trip Point	VCHG_IN - VBATT, rising	200	300	400	mV
	VCHG_IN - VBATT, falling		100		
	VCHG_IN - VBATT, hysteresis		200		
Input Undervoltage Threshold (UV)	VCHG_IN rising, 500mV hysteresis (typ)	3.9	4.0	4.1	V
Input Overvoltage Threshold (OVP)	VCHG_IN rising, 200mV hysteresis (typ)	10.2	10.6	11	V
Input Supply Current	IBATT = 0mA		750	1500	μA
Shutdown Input Current	Charger disabled			500	μA
CHG_IN to BATT Dropout On-Resistance	VCHG_IN = 3.7V, VBATT = 3.6V		0.4	0.8	Ω
SAFE_OUT					
SAFE_OUT Regulated Output	ISAFE_OUT = 15mA, VCHG_IN = 5V, TA = 0°C to +85°C	4.75	4.90	5.00	V
	ISAFE_OUT = 15mA, VCHG_IN = 10V, TA = 0°C to +85°C			5.2	
SAFE_OUT Current Limit			100		mA

System Power Management for Mobile Handset

ELECTRICAL CHARACTERISTICS (continued)

($V_{BATT} = 3.7V$, $V_{CHG_IN} = 5.0V$, circuit of Figure 1, $T_A = -40^{\circ}C$ to $+85^{\circ}C$, unless otherwise noted. Typical values are at $T_A = +25^{\circ}C$.)

PARAMETER	CONDITIONS		MIN	TYP	MAX	UNITS
CHG_MON						
I/V Conversion Factor	Monitoring voltage to charge current - fast-charge current = 450mA (Note 3)		2.666			mV/mA
I/V Accuracy	Overall range		-10		+10	%
Output Voltage	450mA charge current - fast-charge current = 450mA (Note 3)		1200			mV
Charge Monitoring Range			0		1.2	V
Output Impedance			10	20	40	k Ω
INDICATOR LED						
LED3 Current Sink	$V_{CHG_IN} = 5V$, $T_A = 0^{\circ}C$ to $+85^{\circ}C$		1.5	3	5	mA
BATT						
BATT Regulation Voltage	$I_{BATT} = 90mA$, V_{BATT} programmed to 4.2V	$T_A = +25^{\circ}C$	4.179	4.2	4.221	V
		$T_A = -40^{\circ}C$ to $+85^{\circ}C$	4.158	4.2	4.242	
Programmable Restart Fast-Charge Threshold	From BATT regulation voltage, default = disable			-200 -300 -400 Disable		mV
CHG_IN Fast-Charge Current (Note 4)	$V_{BATT} = 3.5V$	CHG_CONTROL_A.FAST_CHARGE = 000b	80	90	100	mA
		001b	240	270	300	
		010b	400	450	500	
		011b	560	630	700	
		100b	630	765	900	
		101b	700	850	1000	
		110b	940	1020	1200	
		111b	1050	1275	1500	
CHG_IN Precharge Current	$V_{BATT} = 2V$			90	100	mA
BATT Prequalification Threshold Voltage	V_{BATT} rising hysteresis 140mV (typ)		2.5	2.55	2.6	V
Soft-Start Time	Ramp time to fast-charge current			2.5		ms
TOP-OFF						
Top-Off Threshold (% of Fast-Charge Current)	I_{BATT} falling, default value = 0%			0 10 20		%
TIMER						
Timer Accuracy			-20		+20	%
Fast-Charge Time Limit	From entering fast-charge to $V_{BATT} < 4.2V$, default value			60		min
Precharge Timer				30		min
Top-Off Timer				30		min
				60		
				120		
				Disable		
Watchdog Timer			2.5	5	10	s

System Power Management for Mobile Handset

MAX8939

ELECTRICAL CHARACTERISTICS (continued)

(VBATT = 3.7V, VCHG_IN = 5.0V, circuit of Figure 1, TA = -40°C to +85°C, unless otherwise noted. Typical values are at TA = +25°C.)

PARAMETER	CONDITIONS	MIN	TYP	MAX	UNITS
THERMAL LOOP					
Thermal Limit Temperature	Junction temperature when the charge current is reduced, TJ rising, default value		+100		°C
OUT1 STEP-UP DC-DC CONVERTER					
Input Voltage (VBATT)		2.9		5.5	V
Input Supply Current	2MHz switching, VOUT = 5V, no load		11		mA
OUT1 Voltage Accuracy	500mA load, default value, TA = +85°C	4.8	5.0	5.2	V
Maximum Output Current	VBATT ≥ 3.2V, VOUT1 = 5.0V	550	700		mA
nFET Current Limit		2.0			A
Line Regulation	VBATT = 2.9V to 4.2V		0.1		%/V
Load Regulation	0 to 500mA load		0.5		%/A
LX1 nFET On-Resistance	LX1 to PGND1, ILX1 = 200mA		0.1	0.2	Ω
LX1 pFET On-Resistance	LX1 to OUT1, ILX1 = -200mA		0.15	0.3	Ω
LX1 Leakage	VLX1 = 5.5V	TA = +25°C	0.1	5	μA
		TA = +85°C	1		
Switching Frequency		1.8	2	2.2	MHz
Maximum Duty Cycle		65	75		%
Minimum Duty Cycle			8		%
COMP Discharge Resistance	During shutdown or UVLO		220		Ω
VIBRATOR					
Programmable Output Voltage OUTVIB	1mA at VBATT = VINVIB = 5.5V, 150mA at VBATT = VINVIB = 3.4V, default value		3		V
Output Current				200	mA
Current Limit	VOUTVIB = 0V		400	600	mA
Dropout Voltage	ILOAD = 135mA, TA = +25°C		150	300	mV
Line Regulation	3.4V ≤ VBATT = VINVIB < 5.5V, ILOAD = 100mA		2.2		mV
Load Regulation	1mA < ILOAD < 200mA		25		mV
Power-Supply Rejection ΔVINVIB/ΔVOUTVIB	f = 10Hz to 10kHz, ILOAD = 30mA		40		dB
Output Noise	100Hz to 100kHz, ILOAD = 30mA		65		μVRMS
Discharge Time Constant	TOFF 90% to 5%, C = 1μF		0.1		ms
Active Stop	nFET on-resistance		1		Ω
Active Brake on Shutdown	nFET on duration		85		ms
LDO1					
Output Voltage Accuracy	ILOAD = 1mA default 2.9V setting	2.813	2.9	2.987	V
Maximum Output Current		400			mA
Current Limit	VLDO1 = 0V		600		mA
Dropout Voltage	ILOAD = 200mA		200	400	mV
Line Regulation	3.4V ≤ VBATT ≤ 5.5V, ILOAD = 100mA		2.4		mV

System Power Management for Mobile Handset

ELECTRICAL CHARACTERISTICS (continued)

(VBATT = 3.7V, VCHG_IN = 5.0V, circuit of Figure 1, TA = -40°C to +85°C, unless otherwise noted. Typical values are at TA = +25°C.)

PARAMETER	CONDITIONS	MIN	TYP	MAX	UNITS
Load Regulation	50 μ A < ILOAD < 200mA		25		mV
Power-Supply Rejection Δ VLDO1/ Δ VBATT	f = 10Hz to 10kHz, ILOAD = 30mA		60		dB
Output Noise Voltage (RMS)	100Hz to 100kHz, ILOAD = 30mA		50		μ VRMS
Ground Current	ILOAD = 500 μ A		21		μ A
Shutdown Discharge Time	T _{OFF} 90% to 10%, C = 4.7 μ F			1	ms
Shutdown Output Impedance			50	80	Ω
LDO2, LDO3					
LDO2 Output Voltage Accuracy	ILOAD = 1mA, default settings	1.746	1.8	1.854	V
LDO3 Output Voltage Accuracy	ILOAD = 1mA, default settings	2.716	2.8	2.884	V
Maximum Output Current		200			mA
Current Limit	Output = 0V		400	700	mA
Dropout Voltage	ILOAD = 135mA		200	400	mV
Line Regulation	3.4V \leq VBATT \leq 5.5V, ILOAD = 100mA		2.4		mV
Load Regulation	50 μ A < ILOAD < 200mA		25		mV
Power-Supply Rejection Δ VLDO_ Δ VBATT	f = 10Hz to 10kHz, ILOAD = 30mA		60		dB
Output Noise Voltage (RMS)	100Hz to 100kHz, ILOAD = 30mA		50		μ VRMS
Ground Current	ILOAD = 500 μ A		21		μ A
Shutdown Discharge Time	T _{OFF} 90% to 10%, C = 1 μ F			1	ms
Shutdown Output Impedance			100	150	Ω
LDO4					
LDO4 Output Accuracy	ILOAD = 1mA default setting	2.716	2.8	2.884	V
Maximum Output Current		100			mA
Current Limit	V _{LDO4} = 0V		200	400	mA
Dropout Voltage	ILOAD = 70mA		200	400	mV
Line Regulation	3.4V \leq VBATT \leq 5.5V, ILOAD = 50mA		2.4		mV
Load Regulation	50 μ A < ILOAD < 100mA		25		mV
Power-Supply Rejection Δ VLDO4/ Δ VBATT	f = 10Hz to 10kHz, ILOAD = 30mA		60		dB
Output Noise	100Hz to 100kHz, ILOAD = 30mA		50		μ VRMS
Ground Current	ILOAD = 500 μ A		25		μ A
Shutdown Discharge Time	T _{OFF} 90% to 10%, C = 1 μ F			1	ms
Shutdown Output Impedance			100	150	Ω
OUT2 WLED STEP-UP CONVERTER					
Input Supply Voltage		2.9		5.5	V
Input Supply Current	2MHz, no load		2	2.5	mA
OUT2 Leakage Current	TA = +25°C, V _{OUT2} = 28V, shutdown		0.1	1	μ A
	TA = +85°C, V _{OUT2} = 28V, shutdown		0.1		

System Power Management for Mobile Handset

MAX8939

ELECTRICAL CHARACTERISTICS (continued)

(VBATT = 3.7V, VCHG_IN = 5.0V, circuit of Figure 1, TA = -40°C to +85°C, unless otherwise noted. Typical values are at TA = +25°C.)

PARAMETER	CONDITIONS	MIN	TYP	MAX	UNITS
LED1, LED2					
Current Regulator Dropout Voltage (Note 3)	25.25mA setting			200	mV
	5.05mA setting			150	
LED_ Regulation Voltage			350		mV
LED_ Current Accuracy	TA = +25°C, ILED_ = 25.25mA	-3		+3	%
	TA = -40°C to +85°C, ILED_ = 25.25mA	-5		+5	
Leakage Current	TA = +25°C, in shutdown		0.01	1	μA
	TA = +85°C, in shutdown		1		
LX2					
nFET Current Limit		710	860		mA
nFET On-Resistance	ILX2 = 200mA		0.3	0.7	Ω
LX2 Leakage Current	TA = +25°C, 28V, shutdown		0.01	1	μA
	TA = +85°C, 28V, shutdown		1		
Operating Frequency		1.8	2	2.2	MHz
Maximum Duty Cycle	VLED1 or VLED2 = 0.2V		92		%
COMP2					
Transconductance			20		μs
Soft-Start Charge Current			60		μA
Discharge Pulldown			20		kΩ
PROTECTION					
Overvoltage Threshold	VOUT2 rising	28		30	V
Overvoltage Hysteresis			4		V
Open LED Detection			100	120	mV
Shorted LED Detection		VOUT2 - 2.2V	VOUT2 - 0.7V		V

Note 1: The monitoring voltage is proportional to the charging current with a ratio depending on the programmed fast-charge current. For the current equal to the fast-charge current, the monitoring voltage is typically 1.2V.

Note 2: The maximum CHG_IN current is the typical value plus 10% for currents up 700mA and the typical value plus 15% for higher currents.

Note 3: LED dropout voltage is defined as the LED_ to ground voltage when current into LED_ drops 10% from the value at VLED_ = 0.5V.

System Power Management for Mobile Handset

Typical Operating Characteristics

($V_{BATT} = 3.7V$, circuit of Figure 1, $T_A = +25^\circ C$, unless otherwise noted.)

OUT1 STEP-UP CONVERTER

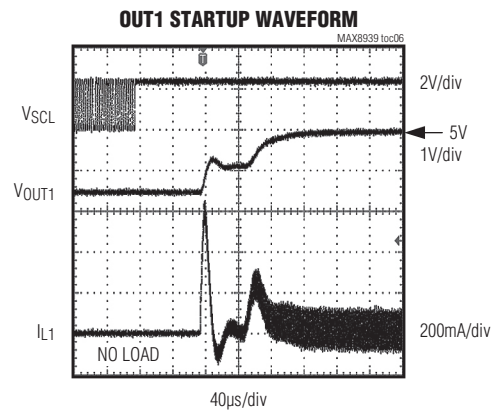
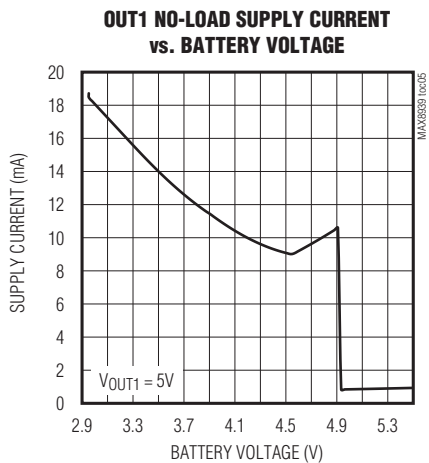
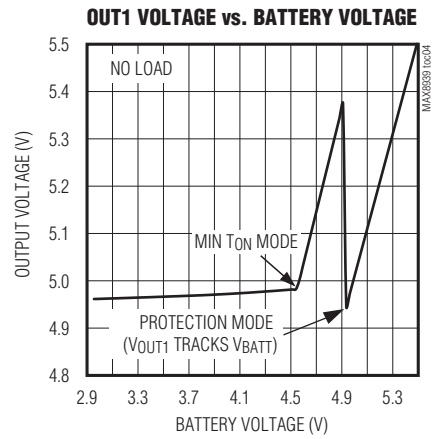
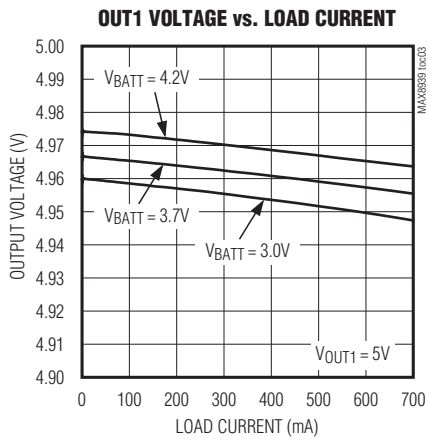
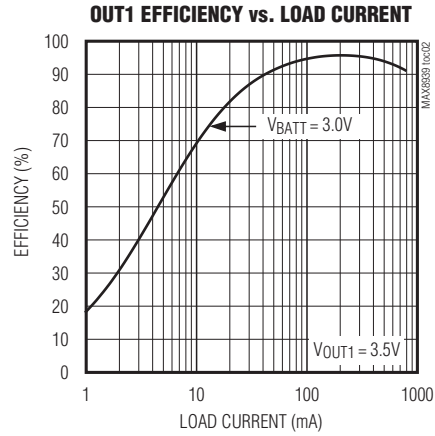
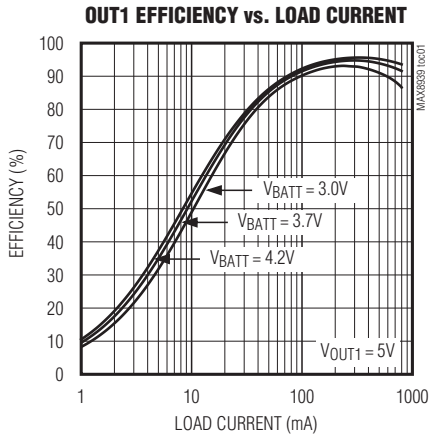

System Power Management for Mobile Handset

Typical Operating Characteristics (continued)

($V_{BATT} = 3.7V$, circuit of Figure 1, $T_A = +25^\circ C$, unless otherwise noted.)

OUT1 STEP-UP CONVERTER (CONTINUED)

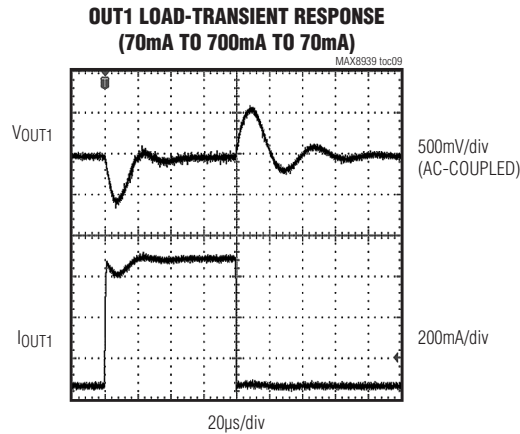
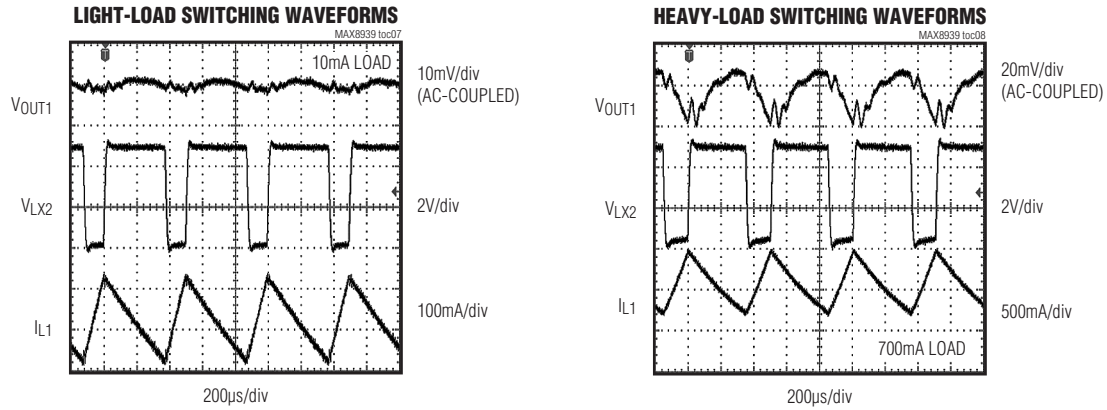

MAX8939

System Power Management for Mobile Handset

Typical Operating Characteristics (continued)

($V_{BATT} = 3.7V$, circuit of Figure 1, $T_A = +25^\circ C$, unless otherwise noted.)

OUT2 WHITE LED DRIVER

**LED EFFICIENCY vs. BATTERY VOLTAGE
2 STRINGS OF 5 LEDS**

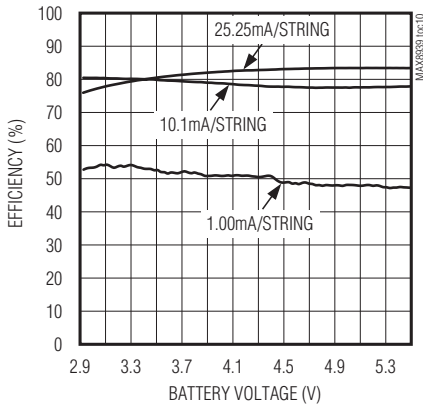

**LED EFFICIENCY vs. BATTERY VOLTAGE
2 STRINGS OF 4 LEDS**

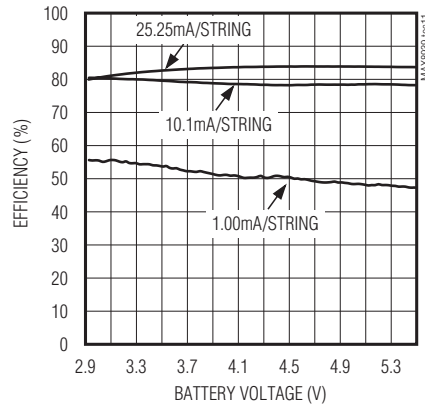

LED STARTUP WAVEFORMS

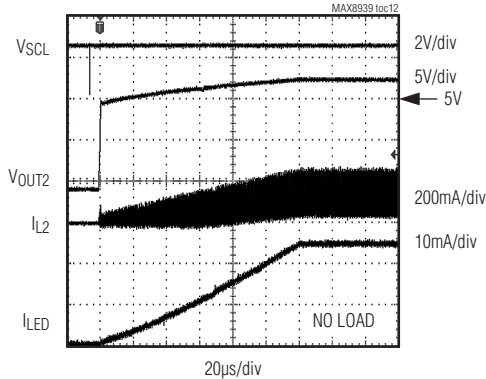

OUT2 SWITCHING WAVEFORMS

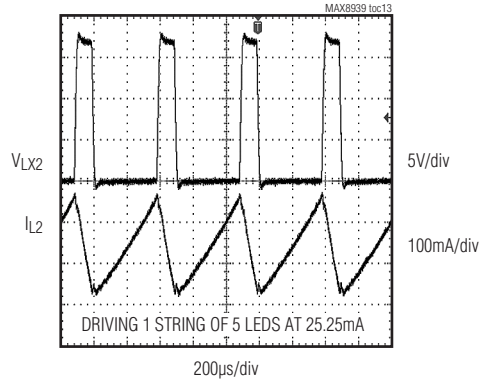

LED RAMP-UP WAVEFORM

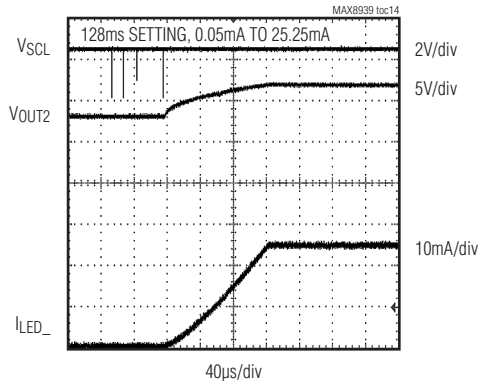

System Power Management for Mobile Handset

Typical Operating Characteristics (continued)

($V_{BATT} = 3.7V$, circuit of Figure 1, $T_A = +25^\circ C$, unless otherwise noted.)

LDOs

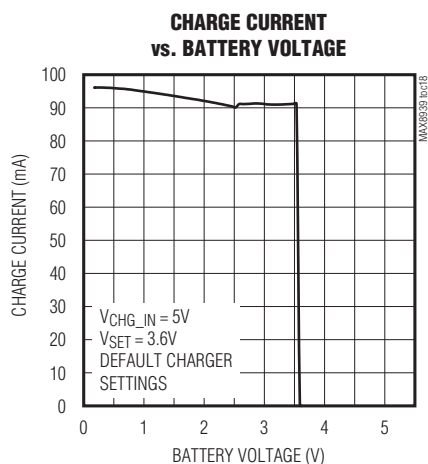
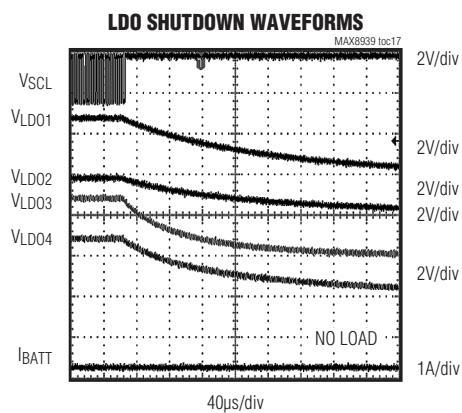
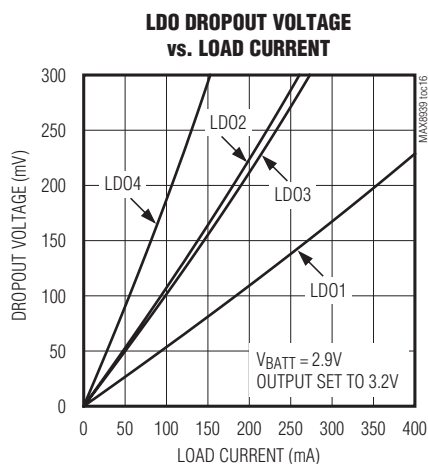
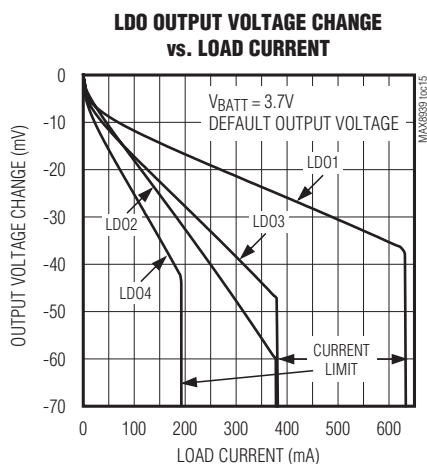

System Power Management for Mobile Handset

Typical Operating Characteristics (continued)

(VBATT = 3.7V, circuit of Figure 1, TA = +25°C, unless otherwise noted.)

BATTERY CHARGER

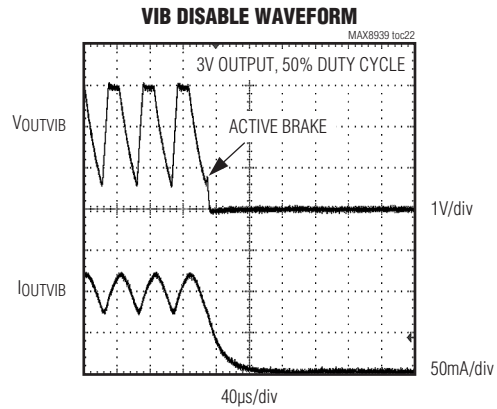
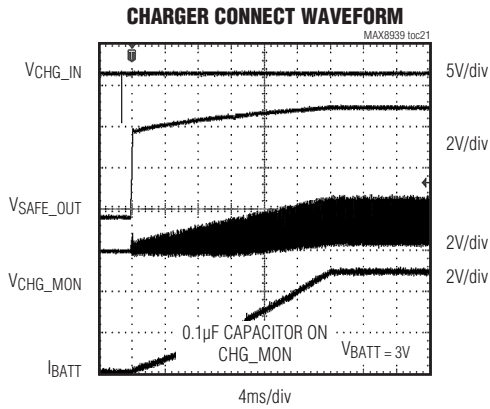
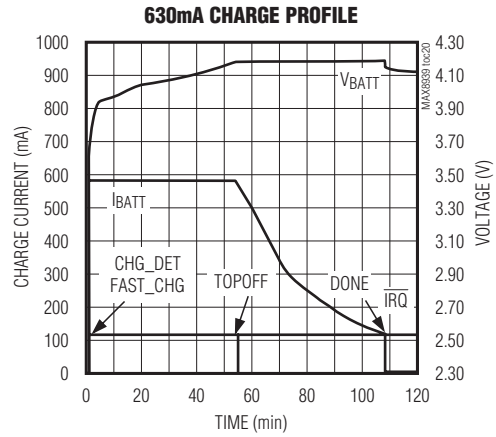
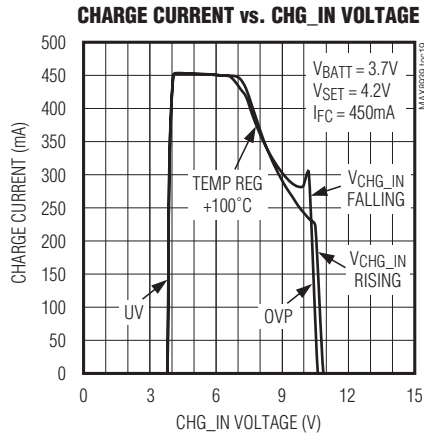

System Power Management for Mobile Handset

Pin Configuration

MAX8939

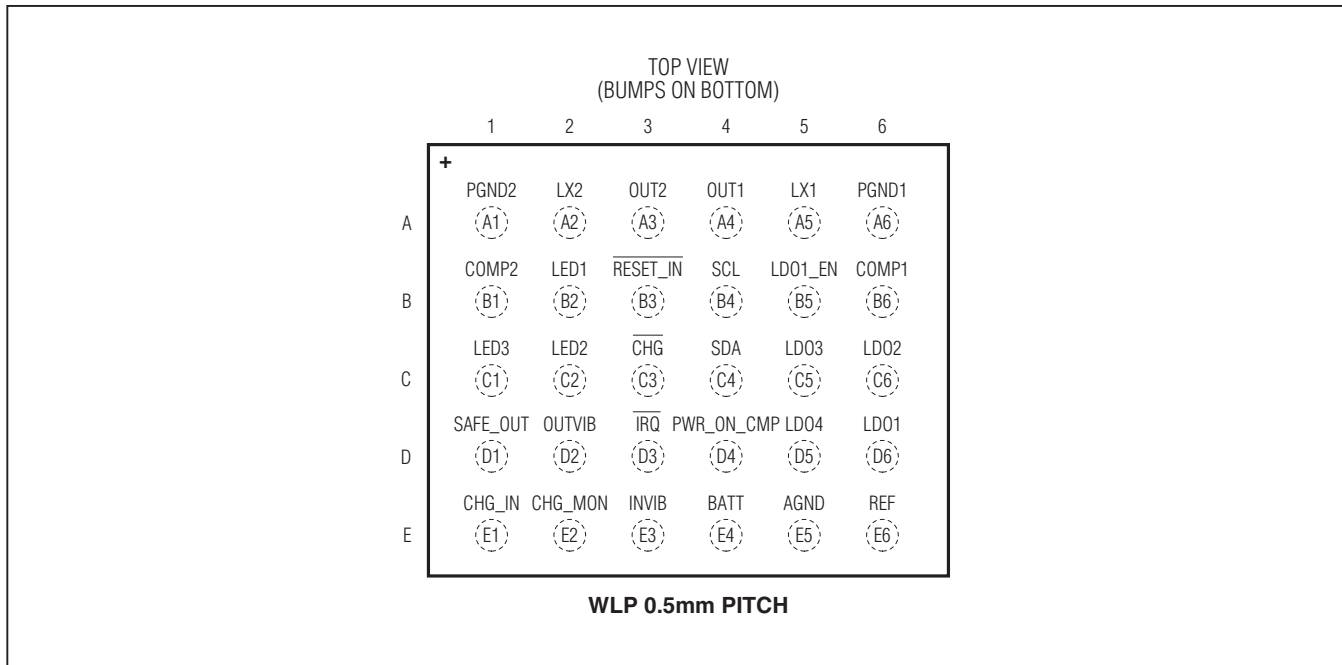

Pin Description

PIN	NAME	FUNCTION
A1	PGND2	Power Ground for WLED Boost Converter. Connect PGND1, PGND2, and AGND to the PCB ground plane.
A2	LX2	Inductor Connection and Switching Node for WLED Boost Converter
A3	OUT2	WLED Step-Up Converter Output. Connect a 1 μ F capacitor from OUT2 to PGND2.
A4	OUT1	Step-Up Converter Output. Connect a 2.2 μ F capacitor from OUT1 to ground.
A5	LX1	Inductor Connection and Switching Node for OUT1 Step-Up Converter
A6	PGND1	Power Ground for OUT1 Step-Up Converter. Connect PGND1, PGND2, and AGND to the PCB ground plane.
B1	COMP2	Step-Up Compensation Node for OUT2 Step-Up Converter. Connect a 0.22 μ F ceramic capacitor from COMP to ground. The applied COMP capacitance stabilizes the converter and sets the soft-start time. COMP discharges to ground through a 20k Ω resistance when in shutdown.
B2	LED1	25mA LED Current Regulator. Connect LED1 to the cathode of the first LED string.
B3	$\overline{\text{RESET_IN}}$	Active-Low Reset Input. Pulse $\overline{\text{RESET_IN}}$ low to reset all registers (except STATUS and EVENT) to their default state.
B4	SCL	Clock Input for I ² C Serial Interface. High impedance when the I ² C interface is off.
B5	LDO1_EN	Enable Input for LDO1. Drive LDO1_EN high to enable LDO1, or low to disable LDO1. Once LDO1 is enabled or disabled through I ² C, the state of LDO1_EN is ignored until reset.
B6	COMP1	Compensation for OUT1 Step-Up Converter. Connect a 2200pF capacitor from COMP1 to ground. See the <i>Soft-Start OUT1</i> section for more details.

System Power Management for Mobile Handset

Pin Description (continued)

PIN	NAME	FUNCTION
C1	LED3	Indicator LED Connection. Connect LED3 to the cathode of the precharge indicator LED. If a precharge indicator LED is not used, leave LED3 unconnected.
C2	LED2	25mA LED Current Regulator. Connect LED2 to the cathode of the second LED string.
C3	$\overline{\text{CHG}}$	Charger Disable Input. Connect $\overline{\text{CHG}}$ high to disable the charger, or low to enable the charger. Once the charger is enabled or disabled through I ² C, the state of $\overline{\text{CHG}}$ is ignored until reset.
C4	SDA	Data Input for Serial Interface. High impedance when the I ² C interface is off.
C5	LDO3	200mA LDO Output. Connect a 2.2 μ F capacitor from LDO3 to ground. In shutdown, LDO3 is pulled to ground through an internal 100 Ω .
C6	LDO2	200mA LDO Output. Connect a 2.2 μ F capacitor from LDO2 to ground. In shutdown, LDO2 is pulled to ground through an internal 100 Ω .
D1	SAFE_OUT	4.9V Regulated LDO Output with Input Overvoltage Protection. Connect a 1 μ F ceramic capacitor from SAFE_OUT to ground. SAFE_OUT can be used to supply low-voltage-rated USB systems and the precharge indicator.
D2	OUTVIB	Vibrator Driver Output. Connect OUTVIB to the vibrator motor. Connect a 1 μ F ceramic capacitor from OUTVIB to ground.
D3	$\overline{\text{IRQ}}$	Interrupt Request Open-Drain Output
D4	PWR_ON_CMP	Open-Drain Output to Wake Sleeping Baseband. PWR_ON_CMP pulses low while the charger is connected. See the PWR_ON_CMP section for details.
D5	LDO4	100mA LDO Output. Connect a 1 μ F capacitor from LDO4 to ground. In shutdown, LDO4 is pulled to ground through an internal 100 Ω .
D6	LDO1	400mA LDO Output. Connect a 4.7 μ F capacitor from LDO1 to ground. In shutdown, LDO1 is pulled to ground through an internal 50 Ω .
E1	CHG_IN	Charger Input Supply Voltage. CHG_IN is the power-supply input for the SAFE_OUT linear regulator and the battery charger. The operating range for the charger input is 4.1V to 10V. CHG_IN is protected up to 28V. When VCHG_IN exceeds 10.6V, SAFE_OUT and the charger are disabled. Connect a 1 μ F or larger ceramic capacitor from CHG_IN to ground.
E2	CHG_MON	Charge Current Monitoring Analog Output. CHG_MON outputs a voltage proportional to the charge current with 1.2V corresponding to the programmed fast-charge current. The CHG_MON output includes ripple from loads on the battery. If this is not desired, connect a small 0.01 μ F to 0.1 μ F capacitor at the input of the ADC to filter the ripple.
E3	INVIB	Input Supply for the Vibrator Driver. Connect INVIB to BATT. Connect a 1 μ F ceramic capacitor from INVIB to PGND.
E4	BATT	Battery Connection and IC Supply Voltage. Connect a 10 μ F ceramic capacitor from BATT to ground.
E5	AGND	Analog Ground. Connect PGND1, PGND2, and AGND to the PCB ground plane.
E6	REF	Reference Noise Bypass. Connect a 0.1 μ F ceramic capacitor from REF to AGND. Do not load. REF is high impedance when shut down.

System Power Management for Mobile Handset

MAX8939

Table 1. Output Summary

SUPPLY	OUTPUT RANGE	DEFAULT STATE AT POWER-UP	DEFAULT VALUE (V)	VOLTAGE TOLERANCE (%)	OUTPUT CURRENT (mA)	DESCRIPTION
LDO1	1.7V to 3.2V in 100mV step	Off	2.9	±3.0	400	Low-noise LDO to supply power either to the RF or analog section. LDO1 is controlled from the I ² C bus or the LDO1_EN input.
LDO2	1.7V to 3.2V in 100mV step	Off	1.8	±3.0	200	Low-noise LDO to supply power either to the RF or analog section. LDO2 is controlled from the I ² C bus.
LDO3	1.7V to 3.2V in 100mV step	Off	2.8	±3.0	200	Low-noise LDO to supply power either to the RF or analog section. LDO3 is controlled from the I ² C bus.
LDO4	1.7V to 3.2V in 100mV step	Off	2.8	±3.0	100	Low-noise LDO to supply power either to the RF or analog section. LDO4 is controlled from the I ² C bus.
OUT1 (STEP-UP)	3.5V to 5.0V in 100mV step	Off	5	±3.0	700	The OUT1 step-up converter provides a 5V power supply for an audio amplifier. The output voltage is programmable through I ² C.
OUT2 (LED)	V _{BATT} to 28V	Off	N/A	N/A	60	The OUT2 step-up converter operates at 2MHz and provides a high-voltage source for the keypad and backlight display drivers.
OUTVIB (Vibrator)	1.3V, 2.5V, 3V, or INVIB bypass	Off	3	±3.0	200	High-power vibrator driver with programmable output voltage and speed control in 70 steps through I ² C. The vibrator driver has active brake with stop.
Battery Charger	One-cell Li+ 3.6V, 4.15V, 4.20V, or 4.25V	N/A*	3.6	±0.6	90 default 1.3A (max)	A stand-alone constant-current, constant voltage (CC/CV), thermally regulated linear charger designed for charging a single-cell lithium-ion (Li+) battery. The charger current and protection timer is programmable through I ² C.
SAFE_OUT	4.9V	N/A*	4.9	±3.0	100 (max)	Protected output SAFE_OUT can be used to supply low-voltage-rated USB systems and the precharge indicator. The output voltage is a fixed 4.9V.

*Subject to valid voltage present at CHG_IN.

System Power Management for Mobile Handset

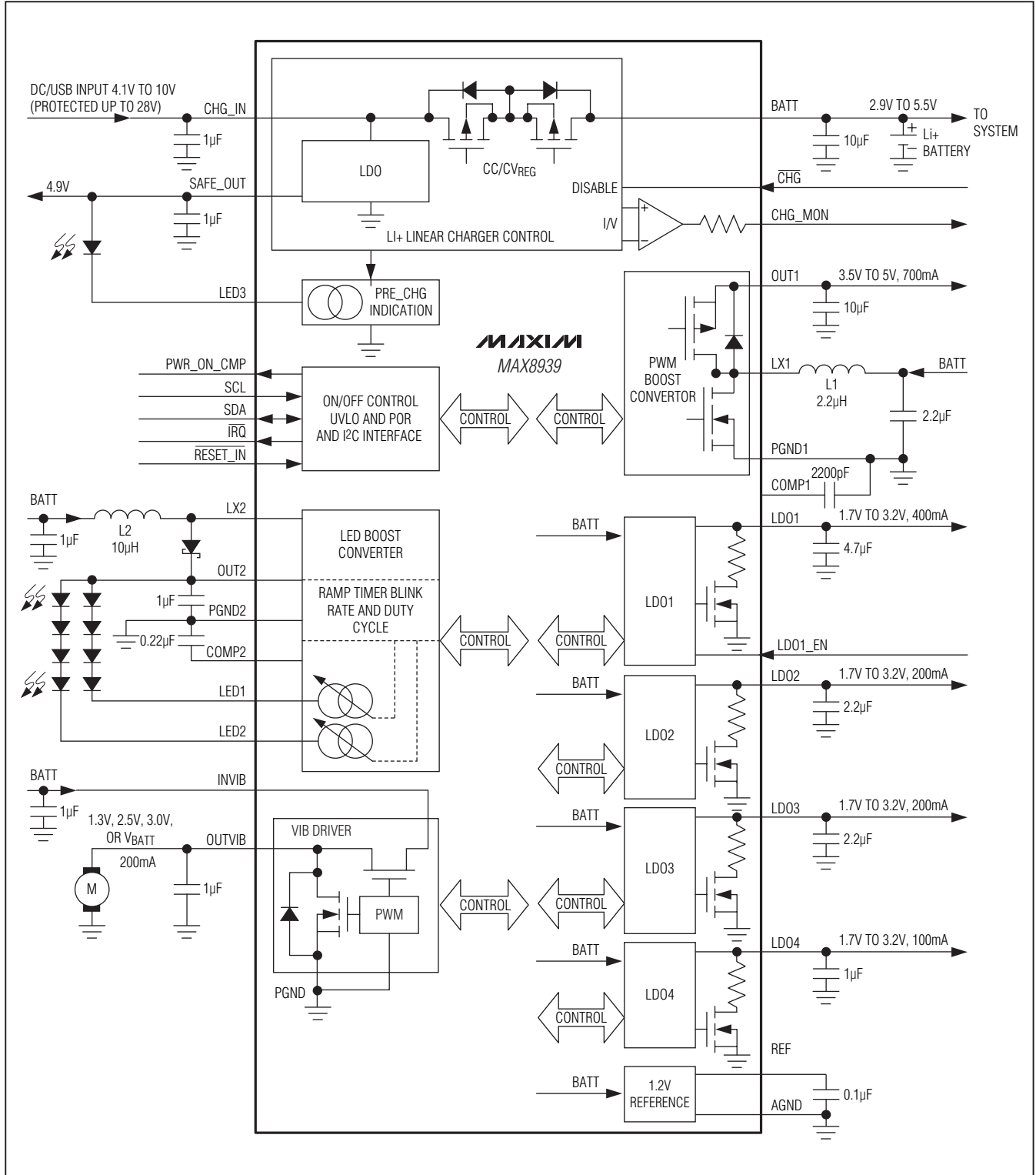

Figure 1. Typical Application Circuit and Block Diagram

System Power Management for Mobile Handset

MAX8939

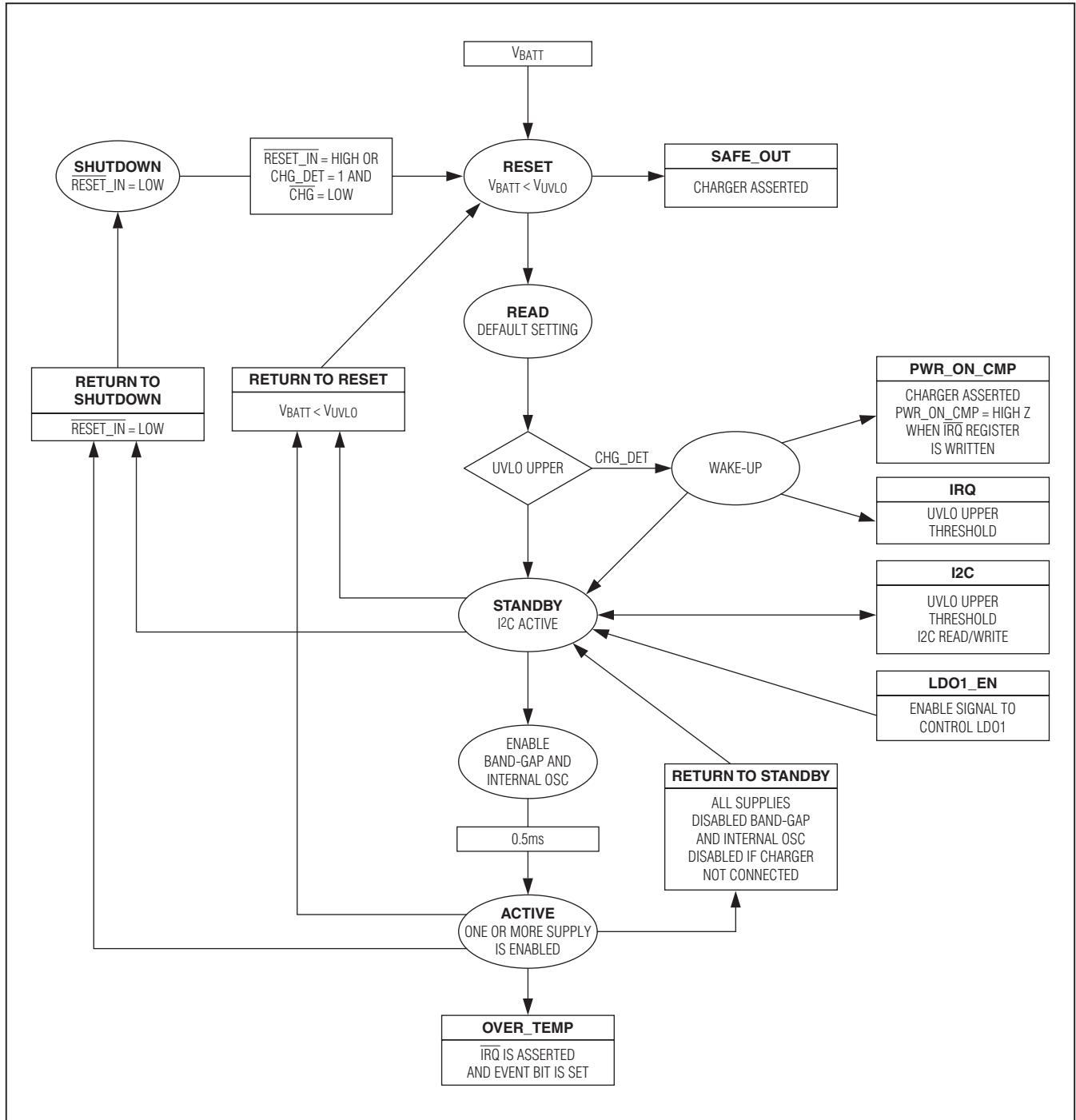

Figure 2. MAX8939 State Diagram

System Power Management for Mobile Handset

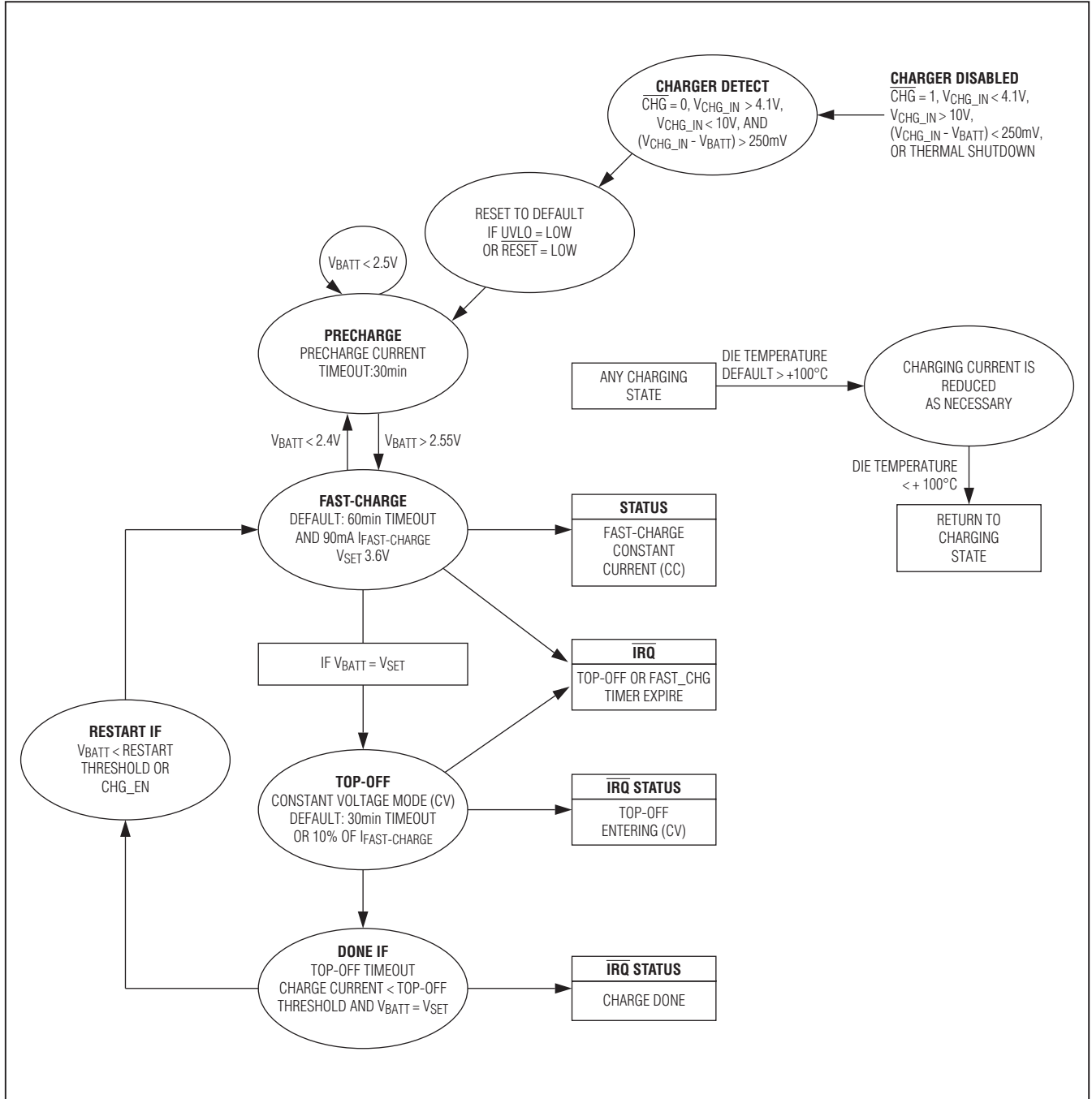

Figure 3. Battery Charger State Diagram

System Power Management for Mobile Handset

Detailed Description

Startup and Power States

To guarantee the correct startup of the MAX8939, an internal power-on reset is generated after the first connection of the battery. This resets the I²C registers to the default values. The MAX8939 is then in reset state. The reset state is a low power level, where the I²C interface is disabled and it is not possible to read or write to any register. The MAX8939 stays in reset state as long as V_{BATT} is below the UVLO upper threshold. When the battery voltage exceeds the UVLO upper threshold, the MAX8939 enters the standby state and the I²C bus can be written to. The typical response time of the UVLO detection is 50μs.

The UVLO upper threshold can be reached three ways:

- Fully charge battery is inserted and $\overline{\text{RESET}}$ is logic-high.
- $\overline{\text{RESET}}$ changes from logic-low to logic-high and $V_{\text{BATT}} > V_{\text{UVLO_UPPER}}$.
- Charger is detected and $\overline{\text{CHG}}$ is logic-low.

This temperature threshold can be programmed in register CHG_CONTROL_A.

Standby is a low-power state where the I²C is ready for read/write operations and enables the different power units (Table 1). If a unit is enabled through I²C or CHG_IN is powered, the bandgap and internal oscillator are started and the MAX8939 moves to the active state. The MAX8939 stays in the active state until the last unit (including the charger) is disabled.

Reset

The MAX8939 enters the reset state when the battery voltage drops below the UVLO lower threshold. In reset, all registers are reset except the STATUS and EVENT registers that retain their values as long as the battery is connected. In reset, all power units are disabled and only the UVLO and CHG_IN detection circuitry is active. If a fully charged battery is inserted or a charger is detected, the MAX8939 enters standby. If a valid charger is connected, the state machine enables the PWR_ON_CMP generator and an interrupt is sent to the host when above the UVLO upper threshold. When a valid charger is detected while in the reset state, the SAFE_OUT LDO is enabled and the charger begins pre-charging the battery.

The shutdown state is an extremely low-power state. To enter shutdown, hold $\overline{\text{RESET}}$ logic-low.

Shutdown

The shutdown state is an extremely low-power state. To enter shutdown, hold $\overline{\text{RESET}}$ logic-low.

In shutdown, all the internal blocks are disabled except the CHG_IN detection. If CHG_IN is asserted, the MAX8939 moves to the reset state and starts charging with the default settings. When entering from shutdown, the charger is reset and the PWR_ON_CMP generator is enabled. If the charger is removed, the MAX8939 moves back to the shutdown state if $\overline{\text{RESET}}$ is still logic-low.

Linear Regulators

The MAX8939 charger uses voltage, current and thermal-control loops to charge a single Li+ cell and to protect the battery. A complete charge cycle covers four states: prequalification (precharge), constant current fast-charge (CC), constant voltage top-off (CV), and charge complete (done). If the battery voltage is below 2.55V, the charger is pre-charging with 90mA until prequalification upper threshold is reached or the maximum precharge time (30min) reached. When the charger is in precharge mode, an LED indicator (LED3) and the SAFE_OUT LDO are turned on; all other functions are disabled.

Once the battery voltage has passed the prequalification upper threshold, the charger enters the fast-charge stage. An analog soft-start is used when entering fast charge to reduce inrush current on the input supply. When fast-charge is in progress, a safety timer is enabled and STATUS can be read out of register 0x02 bit 4. The fast-charge current and safety timer are programmable through the I²C interface. The default battery regulation voltage (V_{SET}) is 3.6V, but can be programmed to 4.15V, 4.2V, or 4.25V.

When the battery voltage reaches V_{SET}, the charger changes to top-off mode (CV). When entering top-off, an $\overline{\text{TRQ}}$ is flagged to indicate that the charger is in constant voltage mode. Top-off mode keeps the voltage constant and the current falls slowly until the top-off current threshold is reached. An $\overline{\text{TRQ}}$ is flagged to indicate charge is done. The top-off current threshold is a percentage of the fast-charge current, the threshold is programmable. When the top-off current threshold is set to 0% and restart is disabled, the top-off mode continues until the top-off timer expires. The top-off timer is programmable and can also be disabled. With the top-off threshold set to 0% and top-off timer disabled, the charger continuously charges the battery with a constant voltage and decreasing charge current. This makes it possible to control the charge algorithm through software, without influence of automatic maintaining charge.

System Power Management for Mobile Handset

To qualify charge as done, the current has to be below top-off current threshold or a timeout has occurred. To maintain the battery voltage, the charger can be programmed to restart once the battery voltage drops below a programmable threshold. When restart is enabled and the battery voltage drops below the restart threshold, the charger starts a new charging cycle by entering fast-charge.

If restart is disabled, the charger stops charging when done and does not maintain the battery voltage. When charge done occurs, an $\overline{\text{IRQ}}$ is sent to the host and a flag is set in register 0x03. Reading the register disables the charger. The charger can be enabled by writing to register 0x09 bit 0 (CHG_EN). If one of the safety timers (fast-charge or top-off) expires, an interrupt is sent to the host and a flag is set in register 0x03. The charger is disabled 5s after the safety times out.

If, at any point while charging the battery, the die temperature approaches the thermal regulation threshold (+100°C default), the MAX8939 reduces the charging current so that the die temperature does not this temperature. This feature not only protects the MAX8939 from overheating, but also allows the higher charge current without risking damage to the system.

Note all charger registers are reset to their default settings by power-on reset (POR) or $\overline{\text{RESET}}$.

Charger Disable ($\overline{\text{CHG}}$)

$\overline{\text{CHG}}$ is a logic input used to enable or disable the charger. Connect $\overline{\text{CHG}}$ high to disable the charger, or low to enable the charger. $\overline{\text{CHG}}$ operates when BATT is below its operating range and when BATT is valid, but prior to accessing the CHG_CONTROL_A register. Once the CHG_CONTROL_A register is accessed, either by reading or writing, the register CHG_CONTROL_A. CHG_EN bit controls the charger status and the state of $\overline{\text{CHG}}$ is ignored (although it still triggers an interrupt unless masked).

SAFE_OUT

SAFE_OUT is an LDO powered from the CHG_IN input. SAFE_OUT is enabled when a charger is detected ($4.1\text{V} < V_{\text{CHG_IN}} < 10\text{V}$) and provides a protected output regulated to 4.9V (5V max). Typically, SAFE_OUT is used to power low-voltage USB systems and the precharge indicator.

Indicator LED

The LED3 output sinks 3mA (typ) to drive an indicator LED. LED3 is on by default and can be controlled by the host by I²C (bit 7 of the REG_CONTROL register). Typically, this LED indicates charge status and SAFE_OUT powers the LED as shown in Figure 1.

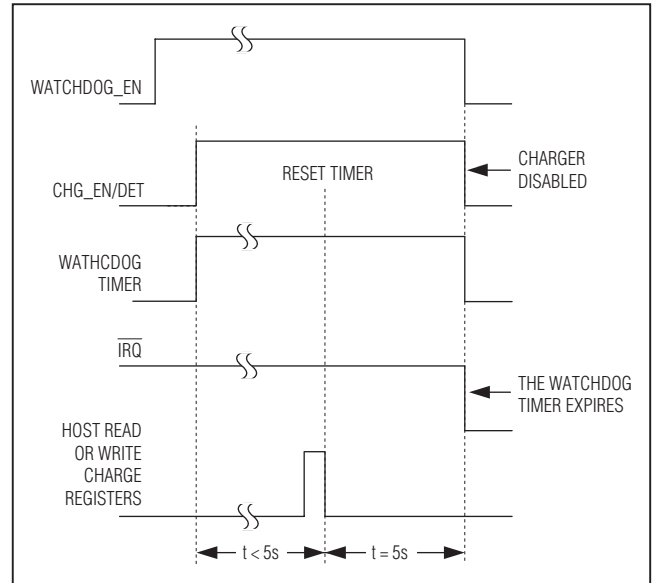

Figure 4. Watchdog Timing Diagram

Charge Current Monitor (CHG_MON)

CHG_MON is an analog output used to monitor the charge current. CHG_MON outputs a voltage proportional to the charge current with 1.2V corresponding to the programmed fast-charge current.

The CHG_MON output includes ripple from loads on the battery. If this is not desired, connect a small 0.01 μF to 0.1 μF capacitor at the input of the ADC to filter the ripple.

Charger Watchdog Timer

During battery fast-charge, a watchdog monitoring function can be activated to ensure that the host processor has control of the charge algorithm. The watchdog timer is enabled through register REG_CONTROL bit WD_EN. When the charger is enabled by CHG_EN or CHG_IN, the watchdog timer starts counting. Within 5s of enabling the charger, the host must read or write register 0x09 or 0x0A to indicate it is alive. This resets the watchdog timer and the host must continue to read or write register 0x09 or 0x0A in intervals of under 5s. If the host takes more than 5s for reading or writing these registers, the watchdog timer expires, generates an interrupt, flags the watchdog timeout in register 0x03, and disables the charger.

Linear Regulators

The MAX8939 includes four low-dropout linear regulators (LDOs). All LDOs are designed for low dropout, low noise, high PSRR, and low quiescent current to maximize battery life. When the battery voltage is above the UVLO upper threshold, the MAX8939 LDOs are ready to be

System Power Management for Mobile Handset

turned on through the I²C interface. The guaranteed current drive capabilities for the LDOs are 400mA for LDO1, 200mA for LDO2 and LDO3, and 100mA for LDO4. The output voltage for each LDO is programmable through the I²C interface from 1.7V to 3.2V in 0.1V steps.

LDO1 can be enabled through a hardware pin LDO1_EN. By connecting this pin to a logic-high level, the LDO enables automatically when the UVLO upper threshold is reached. The LDO can also be controlled by the LDO1_EN bit of the REG_CONTROL. When the LDO1_EN bit is written to, the LDO1 enable state reflects the value written, overriding the state of the LDO1_EN pin. When the state of the LDO1_EN pin changes, the LDO1 enable state is determined by the new state of the LDO1_EN pin, overriding the LDO1_EN bit value. This allows the system software to reduce quiescent power consumption by turning off LDO1 without impacting other logic that may utilize the same hardware control used for the LDO1_EN pin.

Interrupt Request (\overline{IRQ})

\overline{IRQ} is an active-low, open-drain output signal (requires an external pullup resistor) that indicates that an interrupt event has occurred and that the event and status information are available in the event/status registers. Such information includes temperature and voltages inside the MAX8939, fault conditions, etc. The event registers hold information about events that have occurred in the MAX8939. Events are triggered by a status change in the monitored signals. When an event bit is set in the event register, the \overline{IRQ} signal is asserted (unless \overline{IRQ} is masked by a bit in the IRQ mask register). The \overline{IRQ} is also masked during power-up and is not released until the event registers have been read. Each event register is reset to its initial condition after being read. The \overline{IRQ} is not released until all the event registers have been read. New events that occur during read-out of the event registers are held until all the event registers have been read to, ensuring that the host processor does not miss them.

PWR_ON_CMP

PWR_ON_CMP is an open-drain output used to wake-up a sleeping baseband. PWR_ON_CMP is activated when a charger is detected (V_{CHG_IN} is between 4.1V and 10V) and the battery voltage is above the UVLO threshold. If the battery has already reached the UVLO upper threshold, the charger is detected by a rising edge. When such an event is detected, the MAX8939 starts pulsing the PWR_ON_CMP output every 50ms, with a duty cycle of 98%. See Figure 5.

The event is also signaled by \overline{IRQ} , which is asserted when the UVLO upper threshold is reached and the CHG_DET bit is set in register 0x04 (bit 6). The MAX8939 continues pulsing PWR_ON_CMP until the EVENT registers are read, then the register is cleared and PWR_ON_CMP and \overline{IRQ} return to high impedance.

The events causing the PWR_ON_CMP activation are triggered by a rising edge signal that must remain valid for the duration of a 10ms debounce filter.

RESET_IN

RESET_IN is an active-low input signal to the MAX8939 and is used to provide a full system reset inside the MAX8939. As long as RESET_IN is asserted, the MAX8939 is not able to do anything (except the charger), until RESET_IN is released. All registers are cleared except the STATUS and EVENT registers. When RESET_IN is asserted, the EVENT_B bit RESET is set. If the CHG_IN voltage is valid and RESET_IN is asserted, the charger operates in its default state.

OUT1 Step-Up DC-DC Converter

OUT1 is a fixed-frequency PWM step-up converter. The converter switches an internal power MOSFET and synchronous rectifier at a constant 2MHz frequency with varying duty cycle up to 75% to maintain constant output voltage as the input voltage and load current vary.

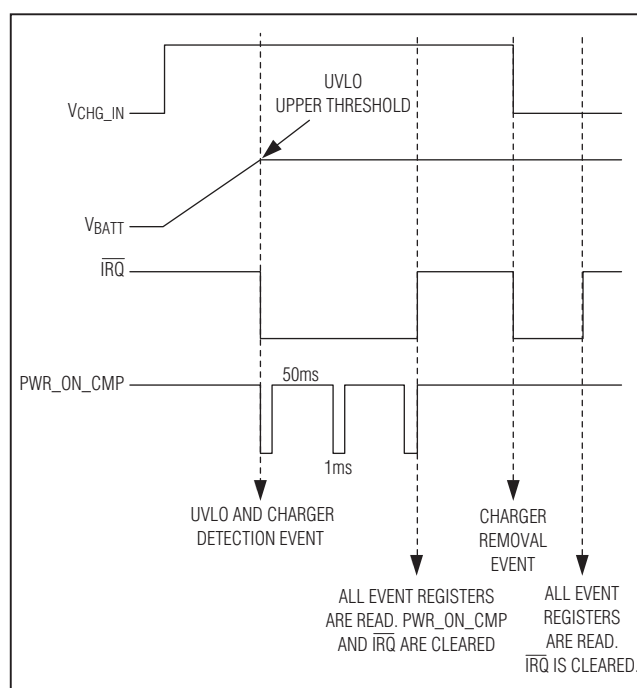

Figure 5. Wake-Up Sequence

System Power Management for Mobile Handset

Internal circuitry prevents any unwanted subharmonic switching in the critical step-down/step-up region by forcing a minimum 8% duty cycle.

OUT1 delivers up to 700mA to the load at a voltage programmable through I²C from 3.5V to 5V in 100mV steps.

Soft-Start OUT1

OUT1 soft-starts by charging CCOMP1 with a 100 μ A current source. During this time, the internal MOSFET is switching at the minimum duty cycle. Once VCOMP1 rises above 1V, the duty cycle increases until the output voltage reaches the desired regulation level. COMP1 is pulled to ground with a 30 Ω internal resistor during UVLO or shutdown.

OUT2 White LED Driver

OUT2 is the output from the step-up DC-DC converter for driving white LEDs. The converter is able to drive up to 60mA at up to 28V. The step-up converter is adaptive connected to the two low-dropout LED current regulators. The step-up converter operates at a fixed 2MHz switching frequency, enabling the use of very small external components to achieve a compact circuit area. For improved efficiency, the step-up converter automatically operates in pulse-skipping mode at light loads.

Soft-Start OUT2

From shutdown, once LED1 or LED2 is enabled through the I²C interface, the step-up converter prepares for soft-start. CCOMP2 is quickly pulled to 1V by an internal pullup clamp. Since the LED_ feedback node voltage is less than the regulation threshold (0.35V typ), 40 μ A current is sourced from the error amplifier and further charges CCOMP2. Once VCOMP2 reaches 1.25V, the step-up converter starts switching at a reduced duty cycle. As VCOMP2 rises, the step-up converter duty cycle increases.

When VLED1 or VLED2 reaches 0.35V (typ), the error amplifier stops sourcing current to CCOMP2, soft-start ends, and the control loop achieves regulation as VLED_ settles. The VCOMP2 where the step-up converter exits

soft-start depends on the load. A 2.5V upper limit to VCOMP2 is imposed to aid in transient recovery and to allow maximum output for low input voltages. CCOMP2 is discharged to ground through a 20k Ω internal resistor whenever the step-up converter is turned off, allowing the device to reinitiate soft-start when it is enabled.

LED1 and LED2 Current Regulators

Each current regulator drives a series string of LEDs. The maximum number of LEDs depends of maximum forward voltage of the LEDs at the maximum desired current. The total forward voltage of the LED string must be below 27.65V. The LED current is independently programmed using the I²C interface from 50 μ A to 25.25mA with a 128-step logarithmic dimming scheme.

Ramp-Up/Down

The MAX8939 LED current regulators provide ramp-up and ramp-down functionality for smooth transitions between different brightness settings. A controlled ramp is used when the LED current level is changed, and when the LEDs are enabled or disabled. LED1 and LED2 have individual ramp control, making it possible to ramp different groups at different rates. The ramp-up and ramp-down times are controlled by the LED_RU and LED_RD control bits, and the ramps are enabled/disabled by the LED_RAMP_EN bits. The MAX8939 increases or decreases the current one step every TRAMP/32 until the target LED current is reached.

Open/Short Detection

The MAX8939 includes comparators to detect open or shorted LEDs on LED1 and LED2. One comparator on each LED_ output detects when the voltage falls below 100mV, indicating an open LED fault. Another comparator on each LED_ output detects when the voltage rises above VOUT2 - 1V, indicating a shorted LED fault. The fault-detection comparators are enabled only when the corresponding LED_ current regulator is enabled and provides a continuous monitor of the current regulator conditions.

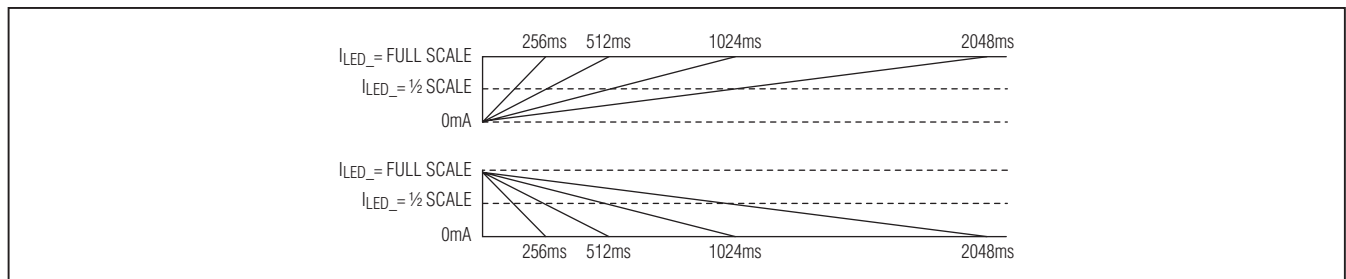

Figure 6. Ramp-Up/Ramp-Down

System Power Management for Mobile Handset

Once a fault is detected, it is flagged in the EVENT_B register and the IRQ signal is asserted (unless masked in the IRQ_MASK_B register).

Overvoltage Protection

If the voltage on the OUT2 rises above 28V (typ), the LED driver is put into the shutdown state. This protects the MAX8939 from excessive voltage in the event of an open-circuit LED.

Vibrator Driver

The vibrator driver is an LDO with PWM control (see Figure 7). The LDO output voltage is programmable through I²C to 1.3V, 2.5V, 3.0V, and V_{BATT}.

The vibrator driver is driven with a PWM signal of duty cycle from 0% to 83% or 100%, with a repetition frequency of 23.8kHz divided into 84 steps. A PWM ratio set to greater than 83 results in the vibrator output being permanently enabled (100%). Figure 8 shows the output waveform at different output voltage and PWM settings. The duty cycle is set by the I²C interface, with a value greater than 0 enabling the PWM mode of operation. By using the enable/disable, an active stop is activated. When the vibrator is disabled, an nFET switch turns on and shorts the vibrator to ground. At the same time the nFET switch works as a recovery diode to protect against reverse voltage from the vibrator.

The MAX8939 includes current protection that limits the current in case the vibrator motor locks up.

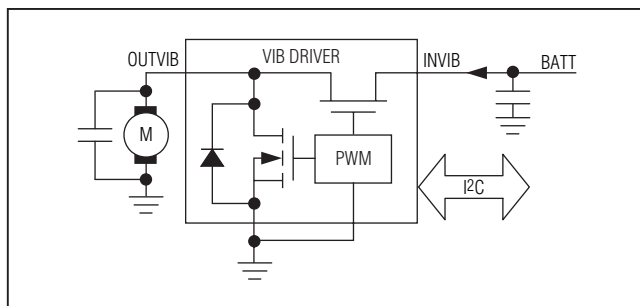

Figure 7. Vibrator Driver

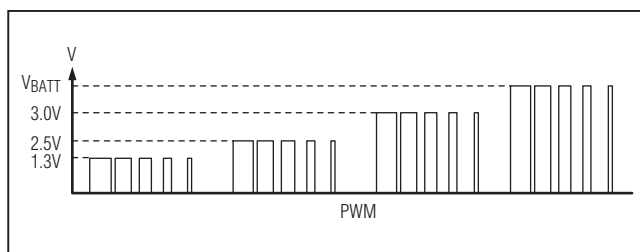

Figure 8. Vibrator Driver PWM Output

Thermal Shutdown

The MAX8939 monitors the die temperature at the charger and each LDO and DC-DC regulator. When the temperature exceeds +160°C, the individual regulator is shutdown. Once the die cools by 20°C, the regulator may be reenabled through the I²C interface.

The charger has independent thermal control circuitry that lowers the charge current to regulate the die temperature during the charge.

I²C Serial Interface

The serial bus consists of a bidirectional serial-data line (SDA) and a serial-clock input (SCL). See Figure 9. The MAX8939 is a slave-only device, relying upon a master to generate the clock signal. The master initiates data transfer on the bus and generates SCL to permit data transfer. The I²C slave address is 0x62 for write operations and 0x63 for read operations.

I²C is an open-drain bus. SDA and SCL require pullup resistors (500Ω or greater). Optional (24Ω) resistors in series with SDA and SCL protect the IC inputs from high-voltage spikes on the bus lines. Series resistors also minimize crosstalk and undershoot on bus signals.

Data Transfer

One data bit is transferred during each SCL clock cycle. The data on SDA must remain stable during the high period of the SCL clock pulse (see Figure 10). Changes in SDA while SCL is high are control signals (see the START and STOP Conditions section for more information).

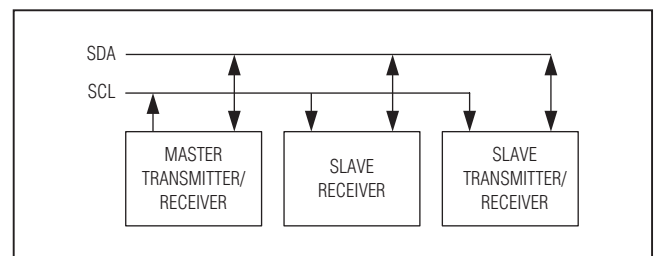

Figure 9. I²C Master/Slave Configuration

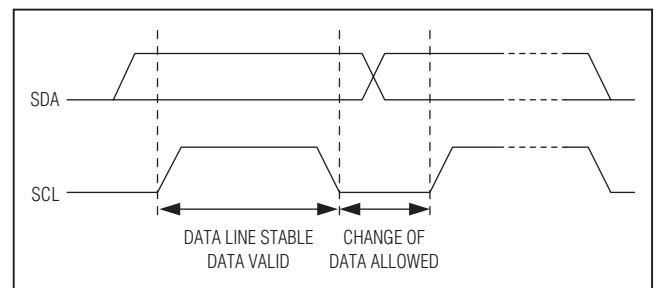

Figure 10. I²C Bit Transfer

System Power Management for Mobile Handset

Each transmit sequence is framed by a START (S) condition and a STOP (P) condition. Each data packet is 9 bits long; 8 bits of data followed by the acknowledge bit. The MAX8939 supports data transfer rates with SCL frequencies up to 400kHz.

START and STOP Conditions

When the serial interface is inactive, SDA and SCL idle high. A master device initiates communication by issuing a START condition. A START condition is a high-to-low transition on SDA with SCL high. A STOP condition is a low-to-high transition on SDA, while SCL is high (Figure 11).

A START condition from the master signals the beginning of a transmission to the MAX8939. The master terminates transmission by issuing a not acknowledge followed by a STOP condition (see the *Acknowledge* section for more information). The STOP condition frees the bus. To issue a series of commands to the slave, the master may issue REPEATED START (Sr) commands instead of a STOP command to maintain control of the bus. In general, a REPEATED START command is functionally equivalent to a regular start command.

When a STOP condition or incorrect address is detected, the MAX8939 internally disconnects SCL from the serial interface until the next START condition, minimizing digital noise and feedthrough.

Acknowledge

Both the master and the MAX8939 (slave) generate acknowledge bits when receiving data. The acknowledge bit is the last bit of each 9-bit data packet. To generate an acknowledge (A), the receiving device must pull SDA low before the rising edge of the acknowledge-related clock pulse (ninth pulse) and keep it low during the high period of the clock pulse (Figure 12). To generate a not acknowledge (NA), the receiving device allows SDA to be pulled high before the rising edge of the acknowledge-related clock pulse and leaves it high during the high period of the clock pulse.

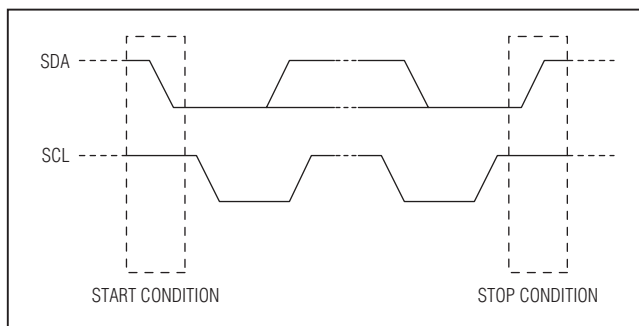

Figure 11. I²C START and STOP Conditions

Monitoring the acknowledge bits allows for detection of unsuccessful data transfers. An unsuccessful data transfer occurs if a receiving device is busy or if a system fault has occurred. In the event of an unsuccessful data transfer, the bus master should reattempt communication at a later time.

Slave Address

A bus master initiates communication with a slave device (MAX8939) by issuing a START condition followed by the slave address. The slave address byte consists of 7 address bits (0110001) and a read/write bit (R/W). After receiving the proper address, the MAX8939 issues an acknowledge by pulling SDA low during the ninth clock cycle.

Write Operations

The MAX8939 recognizes the write byte protocol as defined in the SMBus™ specification and shown in section A of Figure 13. The write byte protocol allows the I²C master device to send 1 byte of data to the slave device. The write byte protocol requires a register pointer address for the subsequent write. The MAX8939 acknowledges any register pointer even though only a subset of those registers actually exists in the device. The write byte protocol is as follows:

- 1) The master sends a START command.
- 2) The master sends the 7-bit slave address followed by a write bit (0x62).
- 3) The addressed slave asserts an acknowledge by pulling SDA low.
- 4) The master sends an 8-bit register pointer.
- 5) The slave acknowledges the register pointer.
- 6) The master sends a data byte.
- 7) The slave updates with the new data.

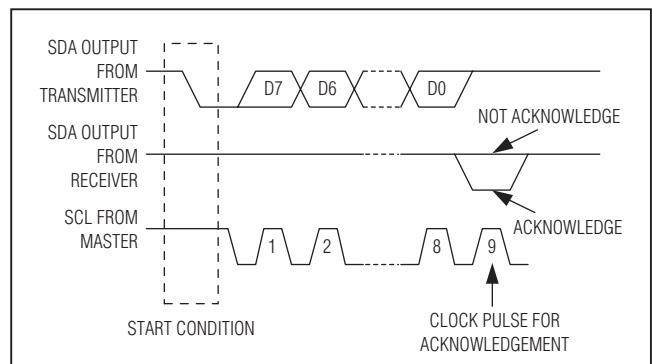

Figure 12. I²C Acknowledge

SMBus is a trademark of Intel Corp.

System Power Management for Mobile Handset

- 8) The slave acknowledges the data byte.
- 9) The master sends a STOP condition.

In addition to the write-byte protocol, the MAX8939 can write to multiple registers as shown in section B of Figure 13. This protocol allows the I²C master device to address the slave only once and then send data to a sequential block of registers starting at the specified register pointer.

Use the following procedure to write to a sequential block of registers:

- 1) The master sends a START command.
- 2) The master sends the 7-bit slave address followed by a write bit (0x62).
- 3) The addressed slave asserts an acknowledge by pulling SDA low.
- 4) The master sends the 8-bit register pointer of the first register to write.
- 5) The slave acknowledges the register pointer.
- 6) The master sends a data byte.
- 7) The slave updates with the new data.
- 8) The slave acknowledges the data byte.

- 9) Steps 6 to 8 are repeated for as many registers in the block, with the register pointer automatically incremented each time.
- 10) The master sends a STOP condition.

Read Operations

The method for reading a single register (byte) is shown in section A of Figure 14. To read a single register:

- 1) The master sends a START command.
- 2) The master sends the 7-bit slave address followed by a write bit (0x62).
- 3) The addressed slave asserts an acknowledge by pulling SDA low.
- 4) The master sends an 8-bit register pointer.
- 5) The slave acknowledges the register pointer.
- 6) The master sends a repeated START condition.
- 7) The master sends the 7-bit slave address followed by a read bit (0x063).
- 8) The slave asserts an acknowledge by pulling SDA low.
- 9) The slave sends the 8-bit data (contents of the register).
- 10) The master asserts a not acknowledge by keeping SDA high.
- 11) The master sends a STOP condition.

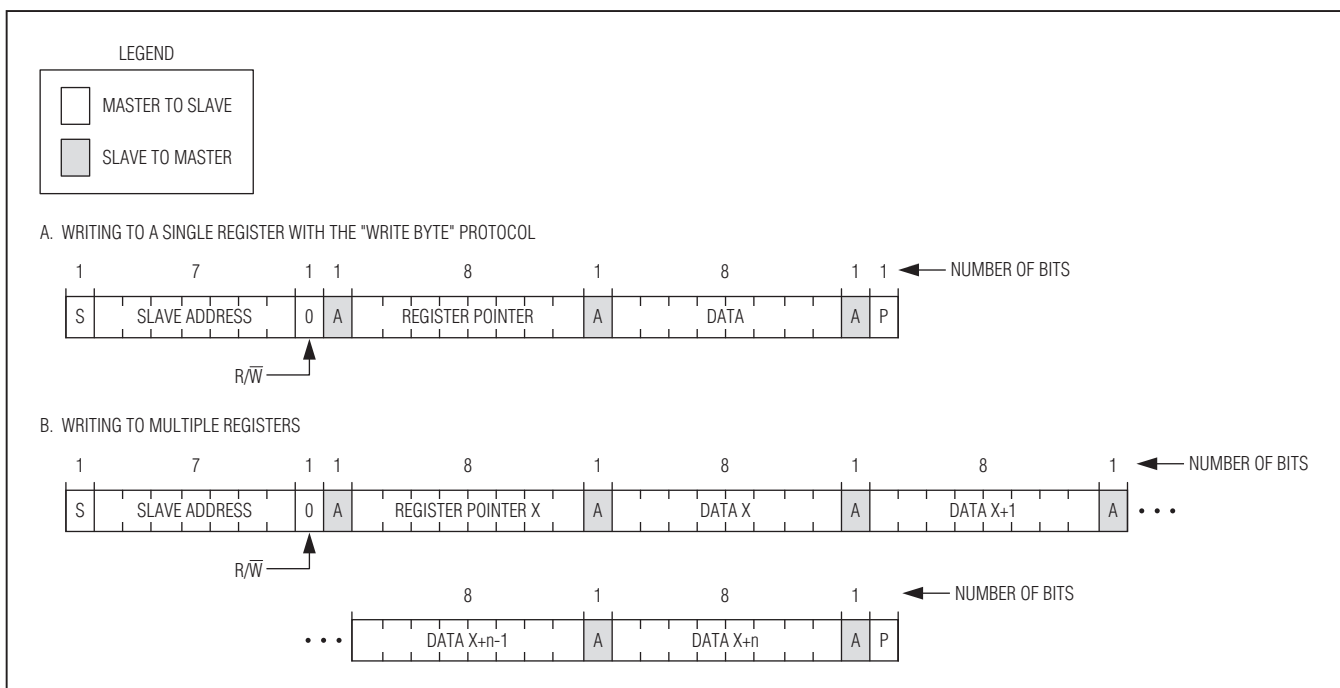

Figure 13. Writing to the MAX8939

System Power Management for Mobile Handset

In addition, the MAX8939 can read a block of multiple sequential registers as shown in section B of Figure 14. Use the following procedure to read a sequential block of registers:

- 1) The master sends a START command.
- 2) The master sends the 7-bit slave address followed by a write bit (0x62).
- 3) The addressed slave asserts an acknowledge by pulling SDA low.
- 4) The master sends an 8-bit register pointer of the first register in the block.
- 5) The slave acknowledges the register pointer.
- 6) The master sends a REPEATED START condition.
- 7) The master sends the 7-bit slave address followed by a read bit (0x063).
- 8) The slave asserts an acknowledge by pulling SDA low.
- 9) The slave sends the 8-bit data (contents of the register).
- 10) The master asserts an acknowledge by pulling SDA low when there is more data to read, or a not acknowledge by keeping SDA high when all data has been read.
- 11) Steps 9 and 10 are repeated for as many registers in the block, with the register pointer automatically incremented each time.
- 12) The master sends a STOP condition.

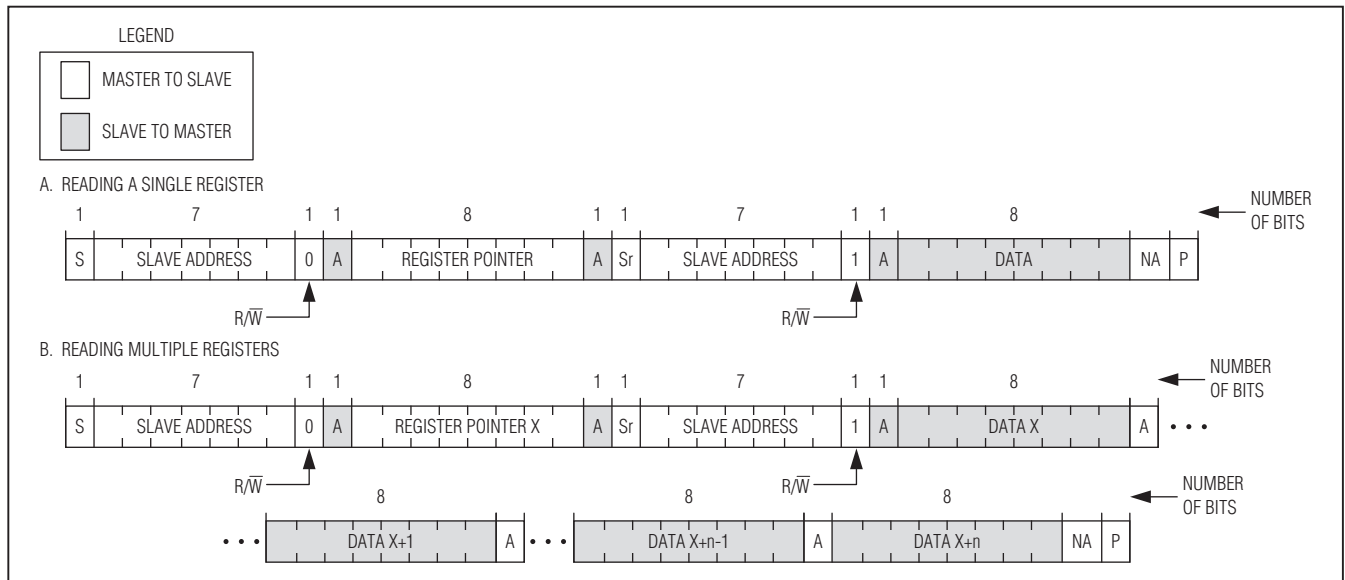

Figure 14. Reading from the MAX8939

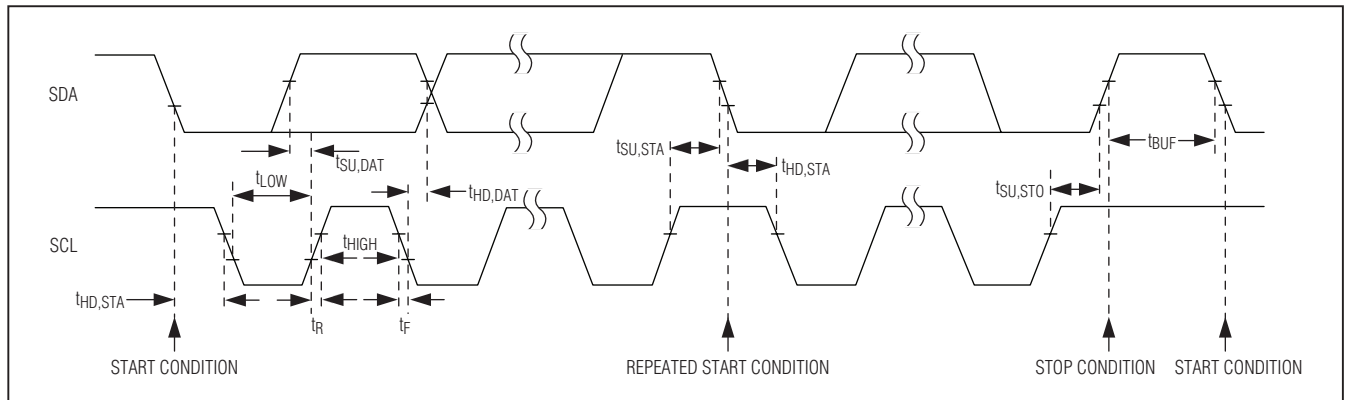

Figure 15. I2C Timing Diagram

System Power Management for Mobile Handset

MAX8939

Table 2. Register Access Types

SYMBOL	REGISTER TYPE	NOTES
R	Read only	A field which is either static or is updated only by hardware. Value written by software is ignored by hardware; that is, software may write any value to this field without affecting hardware behavior.
W	Write only	—
R/W	Read/write	Hardware updates of this field are visible by software read and software updates of this field are visible by a hardware read.
RH	Read only; hardware affected	—
R&C	Read and clear	—
NASR	Not affected by software reset	—

Table 3. Operating Mode

REGISTER	ACCESS TYPE	REGISTER POINTER	POWER-ON DEFAULT	MSB BIT 7	BIT 6	BIT 5	BIT 4	BIT 3	BIT 2	BIT 1	LSB BIT 0
CHIP_ID1	R	0x00	0x56	Die type information							
CHIP_ID2	R	0x01	0x04	Die type and mask revision information							
STATUS	R	0x02	0x00	Reserved	CHG_DET	TOP_OFF	FAST_CHG	LDO1_HWEN	TEMP_REG	DONE	$\overline{\text{CHG}}$
EVENT_A	R/R&C	0x03	0x00	TEMP_REG	CHG_OVP_IN	RESTART	DONE	TOP_OFF	WDOG_TIMEOUT	TIME_OUT	$\overline{\text{CHG}}$
EVENT_B	R/R&C	0x04	0x00	CHG_REM	CHG_DET	UVLO	$\overline{\text{RESET}}$	OVERTEMP	LED2_FAULT	LED1_FAULT	LDO1_HWEN
IRQ_MASK_A	W	0x03	0xFF	TEMP_REG	CHG_OVP_IN	RESTART	DONE	TOP_OFF	WDOG_TIMEOUT	TIME_OUT	$\overline{\text{CHG}}$
IRQ_MASK_B	W	0x04	0xEF	CHG_REM	CHG_DET	UVLO	$\overline{\text{RESET}}$	OVERTEMP	LED2_FAULT	LED1_FAULT	LDO1_HWEN
REG_CONTROL	R/W	0x05	0x80	LED3_EN	WD_EN	BOOST2_EN	BOOST1_EN	LDO4_EN	LDO3_EN	LDO2_EN	LDO1_EN
LDO1/LDO2	R/W	0x06	0x1C	LDO2				LDO1			
LDO3/LDO4	R/W	0x07	0xBB	LDO4				LDO3			
BOOST1	R/W	0x08	0x0F	Reserved				BOOST1			
CHG_CONTROL_A	R/W	0x09	0x1F	FAST_CHARGE			RESTART		TOP_OFF		CHG_EN
CHG_CONTROL_B	R/W	0x0A	0x20	TOPOFF_TIME		TEMP_REG		CCTR		VSET	
LED_RAMP_1	R/W	0x0B	0x80	VIB_VOLTAGE			LED1_RD		LED1_RU		
LED_RAMP_2	R/W	0x0C	0x00	LED2_RAMP_EN	LED1_RAMP_EN	LED2_RD			LED2_RU		
LED1	R/W	0x0D	0x00	EN	ILED1						
LED2	R/W	0x0E	0x00	EN	ILED2						
VIB	R/W	0x0F	0x00	EN	SPEED						

System Power Management for Mobile Handset

Table 4. CHIP_ID1

REGISTER NAME	CHIP_ID1
Register Pointer	0x00
Reset Value	0x56
Type	R

BIT	TYPE	NAME	DESCRIPTION	DEFAULT
0-7	R	Die type	BCD characters 69	0x56

Table 5. CHIP_ID2

REGISTER NAME	CHIP_ID2
Register Pointer	0x01
Reset Value	0x04
Type	R

BIT	TYPE	NAME	DESCRIPTION	DEFAULT
0-7	R	Mask Revision	BCD characters 01	0x04

Table 6. STATUS

REGISTER NAME	STATUS
Register Pointer	0x02
Reset Value	0x00
Type	R

BIT	TYPE	NAME	DESCRIPTION	DEFAULT
0	R	$\overline{\text{CHG}}$	Charger disabled	0
1	R	DONE	Fast-charging complete	0
2	R	TEMP_REG	Charger in thermal regulation	0
3	R	LDO1_HWEN	Enable pin status	0
4	R	FAST_CHG	Fast charging in progress (CC)	0
5	R	TOP_OFF	Top off in progress (CV)	0
6	R	CHG_DET	PWR_ON_CMP asserted by charger detection	0
7	R	Reserved	—	0

System Power Management for Mobile Handset

Table 7. EVENT_A

REGISTER NAME	EVENT_A
Register Pointer	0x03
Reset Value	0x00
Type	R/R&C

BIT	TYPE	NAME	DESCRIPTION	DEFAULT
0	R	$\overline{\text{CHG}}$	Charger disabled caused $\overline{\text{IRQ}}$	0
1	R&C	TIME_OUT	FAST_CHG or TOP_OFF timeout caused $\overline{\text{IRQ}}$	0
2	R&C	WDOG_TIMEOUT	Watchdog timeout caused $\overline{\text{IRQ}}$	0
3	R&C	TOP_OFF	Entering TOP_OFF (CV) caused $\overline{\text{IRQ}}$	0
4	R	DONE	Fast-charging complete caused $\overline{\text{IRQ}}$	0
5	R&C	RESTART	Fast-charging restarted caused $\overline{\text{IRQ}}$	0
6	R&C	CHG_OVP_IN	Charger input overvoltage caused $\overline{\text{IRQ}}$	0
7	R	TEMP_REG	Charger in thermal regulation caused $\overline{\text{IRQ}}$	0

Table 8. EVENT_B

REGISTER NAME	EVENT_B
Register Pointer	0x04
Reset Value	0x00
Type	R/R&C

BIT	TYPE	NAME	DESCRIPTION	DEFAULT
0	R	LDO1_HWEN	Enable pin shift status caused $\overline{\text{IRQ}}$	0
1	R&C	LED1_FAULT	Shorted or open circuitry caused $\overline{\text{IRQ}}$	0
2	R&C	LED2_FAULT	Shorted or open circuitry caused $\overline{\text{IRQ}}$	0
3	R	OVERTEMP	Overtemperature caused $\overline{\text{IRQ}}$	0
4	R&C	$\overline{\text{RESET}}$	$\overline{\text{RESET}}$ asserted	0
5	R&C	UVLO	Undervoltage lockout caused $\overline{\text{IRQ}}$	0
6	R	CHG_DET	PWR_ON_CMP asserted by charger detection and caused $\overline{\text{IRQ}}$ when UVLO upper	0
7	R&C	CHG_REM	Charger removal caused $\overline{\text{IRQ}}$	0

Note: The EVENT registers hold information about events that have occurred in MAX8939. Events are triggered by a change in the status registers, which contains the status of the monitored signals. When an EVENT bit is set in the event register the $\overline{\text{IRQ}}$ signal shall be asserted (unless the $\overline{\text{IRQ}}$ is to be masked by a bit in the $\overline{\text{IRQ}}$ mask register). The $\overline{\text{IRQ}}$ is also masked during the power-up sequence and are not released until the event registers have been read for the first time. The event registers are automatically cleared during read-out operation automatically. The event registers may be read-out in page mode. New events that occur during read-out are delayed before they are passed to the event register, ensuring that the host controller does not miss them.

System Power Management for Mobile Handset

Table 9. IRQ_MASK_A

REGISTER NAME	IRQ_MASK_A
Register Pointer	0x03
Reset Value	0xFF
Type	W

BIT	TYPE	NAME	DESCRIPTION	DEFAULT
0	W	$\overline{\text{CHG}}$	Charger disabled	1
1	W	TIME_OUT	FAST_CHG or TOP_OFF timeout caused $\overline{\text{IRQ}}$	1
2	W	WDOG_TIMEOUT	Watchdog timeout caused $\overline{\text{IRQ}}$	1
3	W	TOP_OFF	Entering TOP_OFF (CV) caused $\overline{\text{IRQ}}$	1
4	W	DONE	Fast-charging complete caused $\overline{\text{IRQ}}$	1
5	W	RESTART	Fast-charging restarted caused $\overline{\text{IRQ}}$	1
6	W	CHG_OVP_IN	Charger input overvoltage caused $\overline{\text{IRQ}}$	1
7	W	TEMP_REG	Charger in thermal regulation caused $\overline{\text{IRQ}}$	1

Table 10. IRQ_MASK_B

REGISTER NAME	IRQ_MASK_B
Register Pointer	0x04
Reset Value	0xEF
Type	W

BIT	TYPE	NAME	DESCRIPTION	DEFAULT
0	W	LDO1_HWEN	Enable pin shift status caused $\overline{\text{IRQ}}$	1
1	W	LED1_FAULT	Shorted or open circuitry caused $\overline{\text{IRQ}}$	1
2	W	LED2_FAULT	Shorted or open circuitry caused $\overline{\text{IRQ}}$	1
3	W	OVERTEMP	Overtemperature caused $\overline{\text{IRQ}}$	1
4	W	$\overline{\text{RESET}}$	$\overline{\text{RESET}}$ asserted	1
5	W	UVLO	Undervoltage lockout caused $\overline{\text{IRQ}}$	1
6	W	CHG_DET	PWR_ON_CMP asserted by charger detection and caused $\overline{\text{IRQ}}$ when UVLO upper	1
7	W	CHG_REM	Charger removal caused $\overline{\text{IRQ}}$	1

System Power Management for Mobile Handset

MAX8939

Table 11. REG_CONTROL

REGISTER NAME	REG_CONTROL
Register Pointer	0x05
Reset Value	0x80
Type	R/W

BIT	TYPE	NAME	DESCRIPTION	DEFAULT
0	R/W	LDO1_EN	Disable LDO1 Enable LDO1	0 1
1	R/W	LDO2_EN	Disable LDO2 Enable LDO2	0 1
2	R/W	LDO3_EN	Disable LDO3 Enable LDO3	0 1
3	R/W	LDO4_EN	Disable LDO4 Enable LDO4	0 1
4	R/W	BOOST1_EN	Disable BOOST1 Enable BOOST1	0 1
5	R/W	BOOST2_EN	Disable BOOST2 (auto ON) Enable BOOST2	0 1
6	R/W	WD_EN	Disable watchdog charger Enable watchdog charger	0 1
7	R/W	LED3_EN	LED3 disabled LED3 enabled	0 1

Table 12. LDO1, LDO2

REGISTER NAME	LDO1, LDO2
Register Pointer	0x06
Reset Value	0x1C
Type	R/W

BIT	TYPE	NAME	DESCRIPTION	DEFAULT	
0	R/W	LDO1	Set LDO1 output voltage.	1100 (2.9V)	
1			0000 1.7V 0001 1.8 0010 1.9 0011 2.0 0100 2.1 0101 2.2 0110 2.3 0111 2.4		1000 2.5 1001 2.6 1010 2.7 1011 2.8 1100 2.9 1101 3.0 1110 3.1 1111 3.2
2					
3					

System Power Management for Mobile Handset

Table 12. LDO1, LDO2 (continued)

BIT	TYPE	NAME	DESCRIPTION	DEFAULT	
4	R/W	LDO2	Sets LDO2 output voltage.		0001 (1.8V)
5			0000 1.7V 0001 1.8 0010 1.9 0011 2.0	1000 2.5 1001 2.6 1010 2.7 1011 2.8	
6			0100 2.1 0101 2.2	1100 2.9 1101 3.0	
7			0110 2.3 0111 2.4	1110 3.1 1111 3.2	

Table 13. LDO3, LDO4

REGISTER NAME	LDO3, LDO4
Register Pointer	0x07
Reset Value	0xBB
Type	R/W

BIT	TYPE	NAME	DESCRIPTION	DEFAULT	
0	R/W	LDO3	Set LDO3 output voltage.		1101 (2.8V)
1			0000 1.7V 0001 1.8 0010 1.9 0011 2.0	1000 2.5 1001 2.6 1010 2.7 1011 2.8	
2			0100 2.1 0101 2.2	1100 2.9 1101 3.0	
3			0110 2.3 0111 2.4	1110 3.1 1111 3.2	
			4	R/W	
5	0000 1.7V 0001 1.8 0010 1.9 0011 2.0	1000 2.5 1001 2.6 1010 2.7 1011 2.8			
6	0100 2.1 0101 2.2	1100 2.9 1101 3.0			
7	0110 2.3 0111 2.4	1110 3.1 1111 3.2			

System Power Management for Mobile Handset

MAX8939

Table 14. BOOST1

REGISTER NAME	BOOST1
Register Pointer	0x08
Reset Value	0x0F
Type	R/W

BIT	TYPE	NAME	DESCRIPTION	DEFAULT	
0	R/W	BOOST1	Set OUT1 voltage.	1111 (5.0V)	
1			0000 3.5V 0001 3.6 0010 3.7 0011 3.8 0100 3.9 0101 4.0 0110 4.1 0111 4.2		1000 4.3V 1001 4.4 1010 4.5 1011 4.6 1100 4.7 1101 4.8 1110 4.9 1111 5.0
2					
3					
4					
4	—	Reserved	—	—	
5					
6					
7					

Table 15. CHG_CONTROL_A

REGISTER NAME	CHG_CONTROL_A
Register Pointer	0x09
Reset Value	0x1F
Type	R/W

BIT	TYPE	NAME	DESCRIPTION	DEFAULT
0	R/W	CHG_EN	Disable charger Enable charger	0 1 1
1	R/W	TOP_OFF	Top-off current threshold	10% 00 20% 01 30% 10 0% 11
2				

System Power Management for Mobile Handset

Table 15. CHG_CONTROL_A (continued)

BIT	TYPE	NAME	DESCRIPTION			DEFAULT
3	R/W	RESTART	Restart threshold	200mV	00	11
4				300mV	01	
	400mV	10				
	Disable	11				
5	R/W	FAST_CHARGE	Fast-charge current	90mA	000	000
				270mA	001	
				450mA	010	
				630mA	011	
6		765mA	100			
		850mA	101			
7		1020mA	110			
		1275mA	111			

Note: Accessing this register resets the watchdog timer. Fast-charge current values are maximum value. Real current may be lower by 10%.

Table 16. CHG_CONTROL_B

REGISTER NAME	CHG_CONTROL_B
Register Pointer	0x0A
Reset Value	0x20
Type	R/W

BIT	TYPE	NAME	DESCRIPTION			DEFAULT
0	R/W	VSET	Charge voltage	3.60	00	00
				4.15	01	
				4.20	10	
				4.25	11	
2	R/W	CCTR	Fast-charge timer for maximum operation time	60min	00	00
				120min	01	
				240min	10	
3				Disabled	11	
4	R/W	TEMP_REG	Thermal regulation	+70C	00	10
				+85°C	01	
				+100°C	10	
5				+115°C	11	
6	R/W	TOPOFF_TIME	Top-off timer for constrained operation	30min	00	00
				60min	01	
				120min	10	
				Disabled	11	
7						

Note: Accessing this register resets the watchdog timer.

System Power Management for Mobile Handset

MAX8939

Table 17. LED_RAMP_1

REGISTER NAME	LED_RAMP_1
Register Pointer	0x0B
Reset Value	0x80
Type	R/W

BIT	TYPE	NAME	DESCRIPTION	DEFAULT		
0	R/W	LED1_RU	Full-scale ramp time	0s	000	000
				0.128s	001	
1				0.256s	010	
				0.512s	011	
2				0.760s	100	
				1.000s	101	
				2.000s	110	
				4.000s	111	
3	R/W	LED1_RD	Full-scale ramp time	0s	000	000
				0.128s	001	
4				0.256s	010	
				0.512s	011	
5				0.760s	100	
				1.000s	101	
				2.000s	110	
				4.000s	111	
6	R/W	VIB_VOLTAGE	Maximum output voltage from VIB driver	1.3V	00	10
				2.5V	01	
7				3.0V	10	
				Bypass	11	

System Power Management for Mobile Handset

Table 18. LED_RAMP_2

REGISTER NAME		LED_RAMP_2			
Register Pointer		0x0C			
Reset Value		0x00			
Type		R/W			

BIT	TYPE	NAME	DESCRIPTION	DEFAULT	
0	R/W	LED2_RU	Full-scale ramp time	0s	000
1				0.128s	001
				0.256s	010
				0.512s	011
				0.760s	100
				1.000s	101
2	2.000s	110			
			4.000s	111	
3	R/W	LED2_RD	Full-scale ramp time	0s	000
4				0.128s	001
				0.256s	010
				0.512s	011
				0.760s	100
				1.000s	101
5	2.000s	110			
			4.000s	111	
6	R/W	LED1_RAMP_EN	Disable LED1 RAMP Enable LED1 RAMP	0 1	0
7	R/W	LED2_RAMP_EN	Disable LED2 RAMP Enable LED2 RAMP	0 1	0

System Power Management for Mobile Handset

MAX8939

Table 19. LED1

REGISTER NAME		LED1					
Register Pointer	0x0D						
Reset Value	0x00						
Type	R/W						

BIT	TYPE	NAME	DESCRIPTION						DEFAULT
0			0x00	0.05mA	0x2B	6.15mA	0x56	15.15mA	
			0x01	0.10	0x2C	6.35	0x57	15.35	
			0x02	0.20	0x2D	6.50	0x58	15.60	
			0x03	0.25	0x2E	6.70	0x59	15.80	
			0x04	0.35	0x2F	6.90	0x5A	16.05	
			0x05	0.45	0x30	7.10	0x5B	16.30	
			0x06	0.55	0x31	7.30	0x5C	16.50	
1			0x07	0.65	0x32	7.45	0x5D	16.75	
			0x08	0.75	0x33	7.65	0x5E	17.00	
			0x09	0.85	0x34	7.85	0x5F	17.25	
			0x0A	1.00	0x35	8.05	0x60	17.45	
			0x0B	1.10	0x36	8.25	0x61	17.70	
			0x0C	1.20	0x37	8.45	0x62	17.95	
			0x0D	1.35	0x38	8.65	0x63	18.20	
2			0x0E	1.45	0x39	8.85	0x64	18.45	
			0x0F	1.60	0x3A	9.05	0x65	18.65	
			0x10	1.75	0x3B	9.25	0x66	18.90	
			0x11	1.85	0x3C	9.45	0x67	19.15	
			0x12	2.00	0x3D	9.65	0x68	19.40	
			0x13	2.15	0x3E	9.90	0x69	19.65	
			0x14	2.30	0x3F	10.1	0x6A	19.90	
3	R/W	ILED1	0x15	2.45	0x40	10.3	0x6B	20.15	0000000
			0x16	2.60	0x41	10.5	0x6C	20.40	
			0x17	2.75	0x42	10.7	0x6D	20.65	
			0x18	2.9	0x43	10.9	0x6E	20.90	
			0x19	3.05	0x44	11.15	0x6F	21.15	
			0x1A	3.2	0x45	11.35	0x70	21.40	
			0x1B	3.35	0x46	11.55	0x71	21.65	
4			0x1C	3.5	0x47	11.8	0x72	21.90	
			0x1D	3.65	0x48	12.00	0x73	22.15	
			0x1E	3.85	0x49	12.20	0x74	22.40	
			0x1F	4	0x4A	12.45	0x75	22.65	
			0x20	4.15	0x4B	12.65	0x76	22.90	
			0x21	4.35	0x4C	12.85	0x77	23.15	
			0x22	4.55	0x4D	13.10	0x78	23.40	
5			0x23	4.7	0x4E	13.30	0x79	23.70	
			0x24	4.9	0x4F	13.55	0x7A	23.95	
			0x25	5.05	0x50	13.75	0x7B	24.20	
			0x26	5.25	0x51	14.00	0x7C	24.45	
			0x27	5.45	0x52	14.20	0x7D	24.70	
			0x28	5.6	0x53	14.45	0x7E	25.00	
			0x29	5.8	0x54	14.65	0x7F	25.25	
6			0x2A	5.95	0x55	14.90			
7	R/W	EN	Disable LED1 Enable LED1				0 1	0	

System Power Management for Mobile Handset

Table 20. LED2

REGISTER NAME		LED2					
Register Pointer		0x0E					
Reset Value		0x00					
Type		R/W					

BIT	TYPE	NAME	DESCRIPTION						DEFAULT
0	R/W	ILED2	0x00	0.05mA	0x2B	6.15mA	0x56	15.15mA	0000000
			0x01	0.10	0x2C	6.35	0x57	15.35	
			0x02	0.20	0x2D	6.50	0x58	15.60	
			0x03	0.25	0x2E	6.70	0x59	15.80	
			0x04	0.35	0x2F	6.90	0x5A	16.05	
1			0x05	0.45	0x30	7.10	0x5B	16.30	
			0x06	0.55	0x31	7.30	0x5C	16.50	
			0x07	0.65	0x32	7.45	0x5D	16.75	
			0x08	0.75	0x33	7.65	0x5E	17.00	
			0x09	0.85	0x34	7.85	0x5F	17.25	
2			0x0A	1.00	0x35	8.05	0x60	17.45	
			0x0B	1.10	0x36	8.25	0x61	17.70	
			0x0C	1.20	0x37	8.45	0x62	17.95	
			0x0D	1.35	0x38	8.65	0x63	18.20	
			0x0E	1.45	0x39	8.85	0x64	18.45	
3			0x0F	1.60	0x3A	9.05	0x65	18.65	
			0x10	1.75	0x3B	9.25	0x66	18.90	
			0x11	1.85	0x3C	9.45	0x67	19.15	
			0x12	2.00	0x3D	9.65	0x68	19.40	
			0x13	2.15	0x3E	9.90	0x69	19.65	
4			0x14	2.30	0x3F	10.10	0x6A	19.90	
			0x15	2.45	0x40	10.30	0x6B	20.15	
			0x16	2.60	0x41	10.50	0x6C	20.40	
			0x17	2.75	0x42	10.70	0x6D	20.65	
			0x18	2.90	0x43	10.90	0x6E	20.90	
5	0x19	3.05	0x44	11.15	0x6F	21.15			
	0x1A	3.20	0x45	11.35	0x70	21.40			
	0x1B	3.35	0x46	11.55	0x71	21.65			
	0x1C	3.50	0x47	11.80	0x72	21.90			
	0x1D	3.65	0x48	12.00	0x73	22.15			
6	0x1E	3.85	0x49	12.20	0x74	22.40			
	0x1F	4.00	0x4A	12.45	0x75	22.65			
	0x20	4.15	0x4B	12.65	0x76	22.90			
	0x21	4.35	0x4C	12.85	0x77	23.15			
	0x22	4.55	0x4D	13.10	0x78	23.40			
7	0x23	4.70	0x4E	13.30	0x79	23.70			
	0x24	4.90	0x4F	13.55	0x7A	23.95			
	0x25	5.05	0x50	13.75	0x7B	24.20			
	0x26	5.25	0x51	14.00	0x7C	24.45			
	0x27	5.45	0x52	14.20	0x7D	24.70			
7	0x28	5.60	0x53	14.45	0x7E	25.00			
	0x29	5.80	0x54	14.65	0x7F	25.25			
	0x2A	5.95	0x55	14.90					
	7	R/W	EN	Disable LED2			0	0	
			Enable LED2			1			

System Power Management for Mobile Handset

MAX8939

Table 21. VIB

REGISTER NAME	VIB
Register Pointer	0x0F
Reset Value	0x00
Type	R/W

BIT	TYPE	NAME	DESCRIPTION						DEFAULT
0	R/W	SPEED	0x00	0.00%	0x21	39.2%	0x42	78.5%	0000000
			0x01	1.19	0x22	40.4	0x43	79.7	
			0x02	2.38	0x23	41.6	0x44	80.9	
			0x03	3.57	0x24	42.8	0x45	82.1	
			0x04	4.76	0x25	44	0x46	100	
1			0x05	5.95	0x26	45.2	...	100	
			0x06	7.14	0x27	46.4	0xFF		
			0x07	8.33	0x28	47.6			
2			0x08	9.52	0x29	48.8			
			0x09	10.7	0x2A	50.0			
			0x0A	11.9	0x2B	51.1			
3			0x0B	13.0	0x2C	52.3			
			0x0C	14.2	0x2D	53.5			
			0x0D	15.4	0x2E	54.7			
4			0x0E	16.6	0x2F	55.9			
			0x0F	17.8	0x30	57.1			
			0x10	19.0	0x31	58.3			
5			0x11	20.2	0x32	59.5			
			0x12	21.4	0x33	60.7			
			0x13	22.6	0x34	61.9			
6	0x14	23.8	0x35	63.0					
	0x15	25.0	0x36	64.2					
	0x16	26.1	0x37	65.4					
7	0x17	27.3	0x38	66.6					
	0x18	28.5	0x39	67.8					
	0x19	29.7	0x3A	69.0					
7	0x1A	30.9	0x3B	70.2					
	0x1B	32.1	0x3C	71.4					
	0x1C	33.3	0x3D	72.6					
7	0x1D	34.5	0x3E	73.8					
	0x1E	35.7	0x3F	75.0					
	0x1F	36.9	0x40	76.1					
7	0x20	38.0	0x41	77.3					
7	R/W	EN	Disable VIB				0	0	
			Enable VIB				1		

System Power Management for Mobile Handset

Applications Information

Inductor Selection

The OUT1 step-up converter is designed to use a 2.2μH to 10μH inductor (see Table 22). To prevent core saturation, ensure that the inductor saturation current rating exceeds the peak inductor current for the application. Calculate the worst-case peak inductor current with the following formula:

$$I_{PEAK} = \frac{V_{OUT} \times I_{OUT(MAX)}}{0.9 \times V_{IN(MIN)}} + \frac{V_{IN(MIN)} \times 0.5\mu s}{2 \times L}$$

The OUT2 LED driver is optimized for using a 10μH inductor, although larger or smaller inductors may be used. Using a smaller inductance results in discontinuous current mode operation over a larger range of output power, whereas use of a larger inductance results in continuous conduction for most of the operating range.

To prevent core saturation, ensure that the inductor's saturation current rating exceeds the peak inductor current for the application. For larger inductor values and continuous conduction operation, calculate the worst-case peak inductor current with the following formula:

$$I_{PEAK} = \frac{V_{OUT} \times I_{OUT(MAX)}}{0.9 \times V_{IN(MIN)}} + \frac{V_{IN(MIN)} \times 0.5\mu s}{2 \times L}$$

For small values of L in discontinuous conduction operation, I_{PEAK} is 860mA (typ). Table 23 provides a list of recommended inductors.

Capacitor Selection

Ceramic capacitors are recommended due to their low ESR. Ensure that the capacitor maintains its capacitance over temperature and DC bias. Generally ceramic capacitors with X5R or X7R temperature characteristics perform well. Note that some small size ceramic capacitors fail to maintain their capacitance when a DC bias is applied and should be avoided. Place the capacitors as close as possible to the IC.

The recommended input and output capacitor values are shown in Figure 1, however, larger value capacitors can be used to further reduce ripple at the expense of size and higher cost.

Compensation

The OUT1 step-up converter is compensated for stability through an external compensation network from COMP1 to ground. A 2200pF ceramic capacitor is recommended.

The OUT2 LED driver is compensated for stability through an external compensation network from COMP2 to ground. A 0.22μF ceramic capacitor is recommended for most applications. Higher C_{COMP2} values increase soft-start duration, as well as the time delay between enabling the step-up converter to initiating soft-start. See the *Soft-Start OUT2* section for more information.

Table 22. Recommended Inductors for L1

MANUFACTURER	PART	INDUCTANCE (μH)	DCR (mΩ)	ISAT (A)	DIMENSIONS (LTYP x WTYP x HMAX) (mm)
Cooper (Coiltronics)	SD3114	2.2	110	1.74	3.0 x 3.0 x 1.45
FDK	MIPF2520	2.2	80	1.3	2.5 x 2.0 x 1.0
	MIPW3226	2.2	100	1.1	3.2 x 2.6 x 1.0
TDK	VLS3012ET	2.2	80	1.35	3 x 3 x 1.2
	VLS3010T	10	390	0.65	3 x 3 x 1.0
TOKO	DE2812C	2.7	75	1.8	3.0 x 3.2 x 1.2
	DE2812C	10	325	0.78	3.0 x 3.2 x 1.2

Table 23. Recommended Inductors for L2

MANUFACTURER	PART	INDUCTANCE (μH)	DCR (mΩ)	ISAT (A)	DIMENSIONS (LTYP x WTYP x HMAX) (mm)
TOKO	1098AS-100M	10	290	0.75	2.8 x 3.0 x 1.2
	1069AS-220M	22	570	0.47	3 x 3 x 1.8
FDK	MIP3226D100M	10	160	0.9	3.2 x 2.6 x 1.0

System Power Management for Mobile Handset

MAX8939

Diode Selection

The OUT2 LED converter uses an external rectifier diode. A Schottky diode is recommended due to its fast recovery time and low forward voltage drop. Ensure that the diode's average and peak current rating exceeds the average output current and peak inductor current. In addition, the diode's reverse breakdown voltage must exceed the maximum V_{OUT2} .

PCB Layout

Due to fast switching waveforms and high current paths, careful PCB layout is required. Minimize trace lengths between the IC and the inductor, the diode, the input capacitor, and the output capacitor. Minimize trace

lengths between the input and output capacitors and the MAX8939 ground terminal, and place input and output capacitor grounds as close together as possible. Use separate power ground and analog ground copper areas, and connect them together at the output capacitor ground. Keep traces short, direct, and wide.

Keep noisy traces, such as the LX_{-} node trace, away from sensitive analog circuitry. For improved thermal performance, maximize the copper area of the LX_{-} and $PGND_{-}$ traces. Refer to the MAX8939 Evaluation Kit for an example layout.

Chip Information

PROCESS: BiCMOS

Typical Operating Circuit

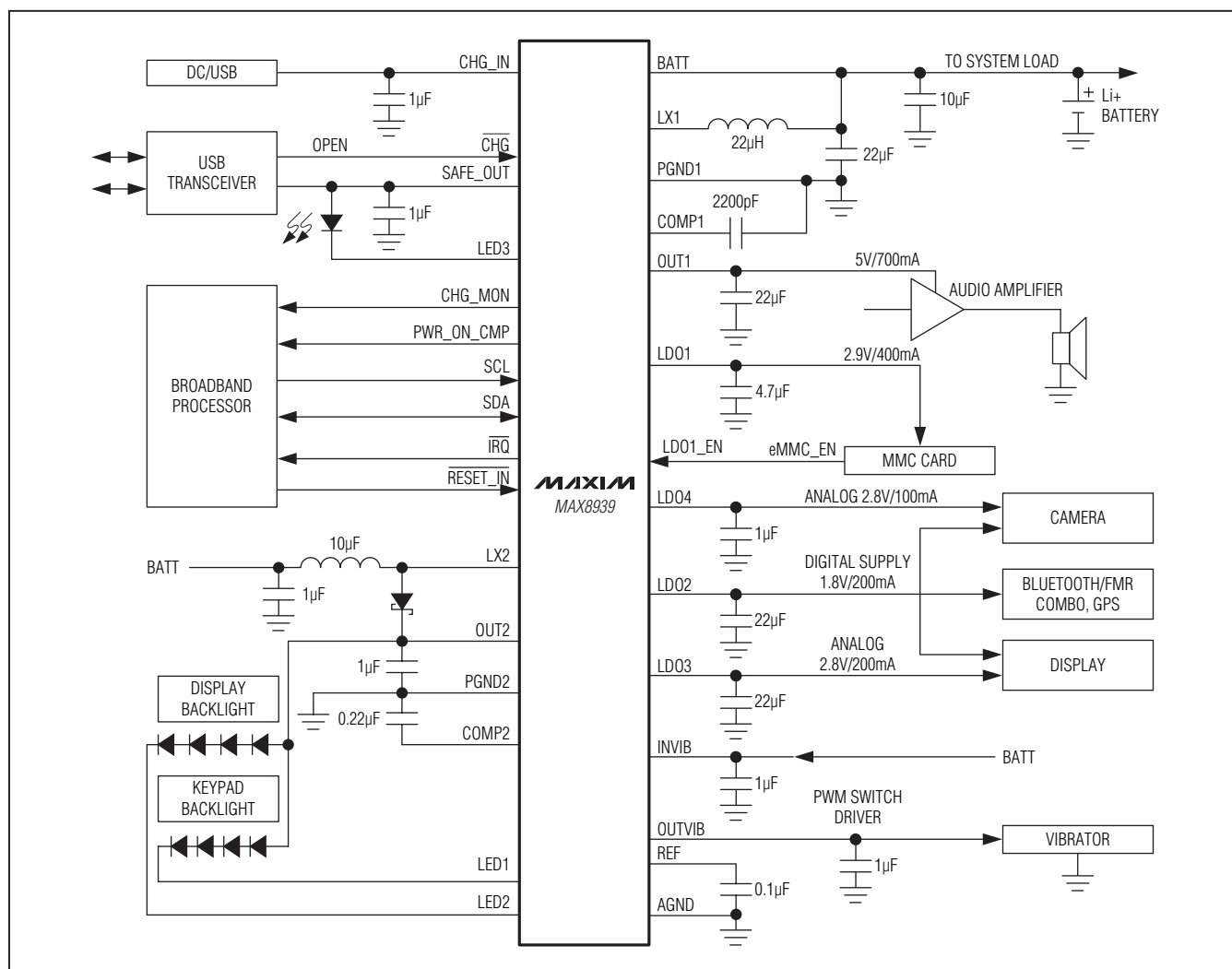

System Power Management for Mobile Handset

Package Information

For the latest package outline information and land patterns (footprints), go to www.maxim-ic.com/packages. Note that a "+", "#", or "-" in the package code indicates RoHS status only. Package drawings may show a different suffix character, but the drawing pertains to the package regardless of RoHS status.

PACKAGE TYPE	PACKAGE CODE	OUTLINE NO.	LAND PATTERN NO.
30 WLP	W302A3+2	21-0016	Refer to Application Note 1891

COMMON DIMENSIONS	
A	0.64±0.05
A1	0.24±0.03
A2	0.40 REF
A3	0.025–0.050 BASIC
b	ø0.31±0.03
D1	2.00 BASIC
E1	2.50 BASIC
e	0.50 BASIC
SD	0.00 BASIC
SE	0.25 BASIC

PKG. CODE	E		D		DEPOPULATED BUMPS
	MIN	MAX	MIN	MAX	
W302A3+1	3.05	3.08	2.55	2.58	B2, B3, B4, C2, C3, C4, D2, D3, D4, D5
W302A3+2	2.95	3.11	2.44	2.60	NONE
W303A3+1	3.21	3.31	2.95	3.05	NONE

NOTES:

1. Terminal pitch is defined by terminal center to center value.
2. Outer dimension is defined by center lines between scribe lines.
3. All dimensions in millimeters.
4. Marking shown is for package orientation reference only.
5. Tolerance is ± 0.02mm unless specified otherwise.
6. All dimensions apply to PbFree (+) package codes only.
7. Front-side finish can be either Black or Clear.

TITLE:
PACKAGE OUTLINE
30 BUMPS, WLP PKG. 0.5mm PITCH

APPROVAL	DOCUMENT CONTROL NO. 21-0016	REV. D	1/1
----------	---------------------------------	-----------	-----

-DRAWING NOT TO SCALE-

System Power Management for Mobile Handset

Revision History

REVISION NUMBER	REVISION DATE	DESCRIPTION	PAGES CHANGED
0	5/11	Initial release	—

MAX8939

Maxim cannot assume responsibility for use of any circuitry other than circuitry entirely embodied in a Maxim product. No circuit patent licenses are implied. Maxim reserves the right to change the circuitry and specifications without notice at any time.

Maxim Integrated Products, 120 San Gabriel Drive, Sunnyvale, CA 94086 408-737-7600 _____ **43**