

G78LXX POSITIVE VOLTAGE REGULATOR

Description

The G78LXX series of positive regulators are available in the TO-92 package and with 5V, 6V, 8V, 9V, 10V, 12V, 15V, 18V and 24V fixed output voltages, making it useful in a wide range of applications. These regulators can provide local on-card regulation, eliminating the distribution problems associated with single point regulation. Each type employs internal current limiting, thermal shut-down and safe operating area protection, making it essentially indestructible. If adequate heat sinking is provided, they can deliver over 100mA output current. Although designed primarily as fixed voltage regulators, these devices can be used with external components to obtain adjustable voltages and currents. G78LXX is characterized for operation from 0°C to +125°C.

Features

- Internal Short-Circuit Current Limiting
- Internal Thermal Overload Protection
- No External Components Required

Package Dimensions

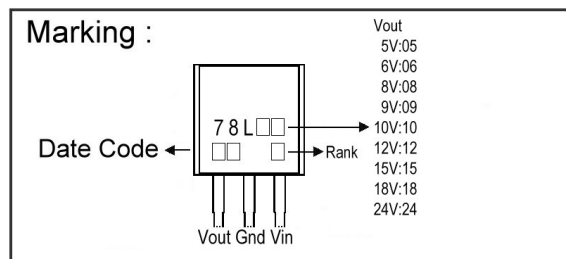
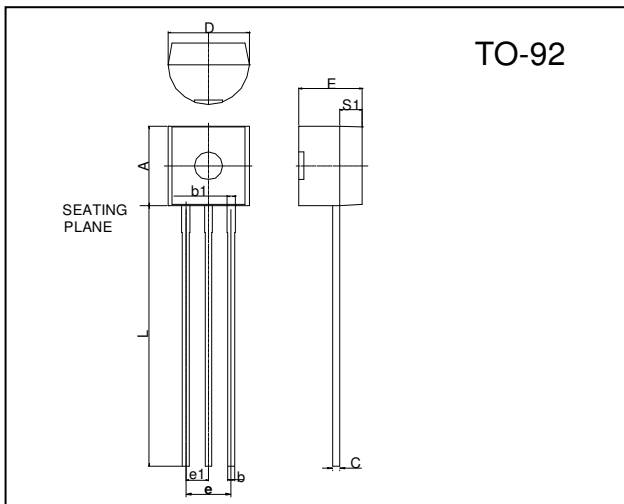

REF.	Millimeter		REF.	Millimeter	
	Min.	Max.		Min.	Max.
A	4.45	4.7	D	4.44	4.7
S ₁	1.02	-	E	3.30	3.81
b	0.36	0.51	L	12.70	-
b ₁	0.36	0.76	e ₁	1.15	1.39
C	0.36	0.51	e	2.42	2.66

Absolute Maximum Ratings

Parameter		Ratings	Unit
Input voltage	G78L05 ~ 10	30	V
	G78L12 ~ 18	35	V
	G78L24	40	V
Output current		100	mA
Operating junction temperature range		0 ~ 125	°C
Storage temperature range		-55 ~ 150	°C
Power Dissipation		625*	mW

*When tested in free air condition, without heat sinking.

Electrical Characteristics

G78L05 (Refer to the test circuits, Tj=0~125°C, Io=40mA, Vin=10V, Cin=0.33μF, Co=0.1μF unless otherwise specified) (Note1)

Symbol		Min.	Typ.	Max.	Unit	Test Conditions
VO	A-Rank (3%)	4.85	5.0	5.15	V	Vin=10V, Io=40mA, Tj=25°C 7V ≤ Vin ≤ 20V, 1mA ≤ Io ≤ 40mA 7V ≤ Vin ≤ Vmax, 1mA ≤ Io ≤ 70mA (Note2)
	B-Rank (5%)	4.75	-	5.25		
ΔVO (Line Regulation)		-	18	75	mV	7V ≤ Vin ≤ 20V, Io=40mA, Tj=25°C
		-	10	54		8V ≤ Vin ≤ 20V, Io=40mA, Tj=25°C
ΔVO (Load Regulation)		-	20	60	mV	Vin=10V, 1mA ≤ Io ≤ 100mA, Tj=25°C
		-	5	30		Vin=10V, 1mA ≤ Io ≤ 40mA, Tj=25°C
IQ		-	3.0	5.0	mA	Vin=10V, Io=0mA, Tj=25°C
Δ IQ		-	-	0.1	mA	Vin=10V, 1mA ≤ Io ≤ 40mA
		-	-	1.0		8V ≤ Vin ≤ 20V, Io=40mA
Vn		-	40	-	μV	10Hz ≤ f ≤ 100KHz
RR		47	62	-	dB	8V ≤ Vin ≤ 20V, Io=40mA, f=120Hz, Tj=25°C
VD		-	1.7	-	V	Io=100mA, Tj=25°C
ΔVo / ΔTj		-	-0.65	-	mV/°C	Io=5mA, 0°C ≤ Tj ≤ 125°C

G78L06 (Refer to the test circuits, Tj=0~125°C, Io=40mA, Vin=12V, Cin=0.33μF, Co=0.1μF unless otherwise specified) (Note1)

Symbol		Min.	Typ.	Max.	Unit	Test Conditions
VO	A-Rank (3%)	5.82	6.0	6.18	V	Vin=12V, Io=40mA, Tj=25°C 8.5V ≤ Vin ≤ 20V, 1mA ≤ Io ≤ 40mA 8.5V ≤ Vin ≤ Vmax, 1mA ≤ Io ≤ 70mA (Note2)
	B-Rank (5%)	5.70	-	6.30		
ΔVO (Line Regulation)		-	64	175	mV	8.5V ≤ Vin ≤ 20V, Io=40mA, Tj=25°C
		-	54	125		9V ≤ Vin ≤ 20V, Io=40mA, Tj=25°C
ΔVO (Load Regulation)		-	12.8	80	mV	Vin=12V, 1mA ≤ Io ≤ 100mA, Tj=25°C
		-	5.8	40		Vin=12V, 1mA ≤ Io ≤ 70mA, Tj=25°C
IQ		-	3.9	6.0	mA	Vin=12V, Io=0mA, Tj=25°C
Δ IQ		-	-	0.1	mA	Vin=12V, 1mA ≤ Io ≤ 40mA
		-	-	1.5		9V ≤ Vin ≤ 20V, Io=40mA
Vn		-	49	-	μV	10Hz ≤ f ≤ 100KHz
RR		40	46	-	dB	10V ≤ Vin ≤ 20V, Io=40mA, f=120Hz, Tj=25°C
VD		-	1.7	-	V	Io=100mA, Tj=25°C
ΔVo / ΔTj		-	0.75	-	mV/°C	Io=5mA, 0°C ≤ Tj ≤ 125°C

G78L08 (Refer to the test circuits, Tj=0~125°C, Io=40mA, Vin=14V, Cin=0.33μF, Co=0.1μF unless otherwise specified) (Note1)

Symbol		Min.	Typ.	Max.	Unit	Test Conditions
VO	A-Rank (3%)	7.76	8.0	8.24	V	Vin=14V, Io=40mA, Tj=25°C 10.5V ≤ Vin ≤ 23V, 1mA ≤ Io ≤ 40mA 10.5V ≤ Vin ≤ Vmax, 1mA ≤ Io ≤ 70mA (Note2)
	B-Rank (5%)	7.60	-	8.40		
ΔVO (Line Regulation)		-	10	175	mV	10.5V ≤ Vin ≤ 23V, Io=40mA, Tj=25°C
		-	8	125		11V ≤ Vin ≤ 23V, Io=40mA, Tj=25°C
ΔVO (Load Regulation)		-	15	80	mV	Vin=14V, 1mA ≤ Io ≤ 100mA, Tj=25°C
		-	8	40		Vin=14V, 1mA ≤ Io ≤ 70mA, Tj=25°C
IQ		-	2.0	5.5	mA	Vin=14V, Io=0mA, Tj=25°C
Δ IQ		-	-	0.1	mA	Vin=14V, 1mA ≤ Io ≤ 40mA
		-	-	1.5		11V ≤ Vin ≤ 23V, Io=40mA
Vn		-	49	-	μV	10Hz ≤ f ≤ 100KHz
RR		39	45	-	dB	11V ≤ Vin ≤ 21V, Io=40mA, f=120Hz, Tj=25°C
VD		-	1.7	-	V	Io=100mA, Tj=25°C
ΔVo / ΔTj		-	0.75	-	mV/°C	Io=5mA, 0°C ≤ Tj ≤ 125°C

G78L09 (Refer to the test circuits, $T_j=0\sim 125^{\circ}\text{C}$, $I_o=40\text{mA}$, $V_{in}=15\text{V}$, $C_{in}=0.33\mu\text{F}$, $C_o=0.1\mu\text{F}$ unless otherwise specified) (Note1)

Symbol		Min.	Typ.	Max.	Unit	Test Conditions
VO	A-Rank (3%)	8.73	9.0	9.27	V	$V_{in}=15\text{V}$, $I_o=40\text{mA}$, $T_j=25^{\circ}\text{C}$ $11.5\text{V} \leq V_{in} \leq 24\text{V}$, $1\text{mA} \leq I_o \leq 40\text{mA}$ $11.5\text{V} \leq V_{in} \leq V_{max}$, $1\text{mA} \leq I_o \leq 70\text{mA}$ (Note2)
	B-Rank (5%)	8.55	-	9.45		
ΔVO (Line Regulation)		-	90	200	mV	$11.5\text{V} \leq V_{in} \leq 24\text{V}$, $I_o=40\text{mA}$, $T_j=25^{\circ}\text{C}$ $13\text{V} \leq V_{in} \leq 24\text{V}$, $I_o=40\text{mA}$, $T_j=25^{\circ}\text{C}$
		-	100	150		
ΔVO (Load Regulation)		-	20	90	mV	$V_{in}=15\text{V}$, $1\text{mA} \leq I_o \leq 100\text{mA}$, $T_j=25^{\circ}\text{C}$ $V_{in}=15\text{V}$, $1\text{mA} \leq I_o \leq 40\text{mA}$, $T_j=25^{\circ}\text{C}$
		-	10	45		
IQ		-	2.0	6.0	mA	$V_{in}=15\text{V}$, $I_o=0\text{mA}$, $T_j=25^{\circ}\text{C}$
ΔIQ		-	-	0.1	mA	$V_{in}=15\text{V}$, $1\text{mA} \leq I_o \leq 40\text{mA}$ $13\text{V} \leq V_{in} \leq 24\text{V}$, $I_o=40\text{mA}$
		-	-	1.5		
Vn		-	49	-	μV	$10\text{Hz} \leq f \leq 100\text{KHz}$
RR		38	44	-	dB	$12\text{V} \leq V_{in} \leq 23\text{V}$, $I_o=40\text{mA}$, $f=120\text{Hz}$, $T_j=25^{\circ}\text{C}$
VD		-	1.7	-	V	$I_o=100\text{mA}$, $T_j=25^{\circ}\text{C}$
$\Delta\text{Vo} / \Delta\text{Tj}$		-	0.75	-	$\text{mV}/^{\circ}\text{C}$	$I_o=5\text{mA}$, $0^{\circ}\text{C} \leq T_j \leq 125^{\circ}\text{C}$

G78L10 (Refer to the test circuits, $T_j=0\sim 125^{\circ}\text{C}$, $I_o=40\text{mA}$, $V_{in}=17\text{V}$, $C_{in}=0.33\mu\text{F}$, $C_o=0.1\mu\text{F}$ unless otherwise specified) (Note1)

Symbol		Min.	Typ.	Max.	Unit	Test Conditions
VO	A-Rank (3%)	9.70	10.0	10.30	V	$V_{in}=17\text{V}$, $I_o=40\text{mA}$, $T_j=25^{\circ}\text{C}$ $13\text{V} \leq V_{in} \leq 25\text{V}$, $1\text{mA} \leq I_o \leq 40\text{mA}$ $13\text{V} \leq V_{in} \leq V_{max}$, $1\text{mA} \leq I_o \leq 70\text{mA}$ (Note2)
	B-Rank (5%)	9.50	-	10.50		
ΔVO (Line Regulation)		-	51	175	mV	$13\text{V} \leq V_{in} \leq 25\text{V}$, $I_o=40\text{mA}$, $T_j=25^{\circ}\text{C}$ $14\text{V} \leq V_{in} \leq 25\text{V}$, $I_o=40\text{mA}$, $T_j=25^{\circ}\text{C}$
		-	42	125		
ΔVO (Load Regulation)		-	20	90	mV	$V_{in}=17\text{V}$, $1\text{mA} \leq I_o \leq 100\text{mA}$, $T_j=25^{\circ}\text{C}$ $V_{in}=17\text{V}$, $1\text{mA} \leq I_o \leq 40\text{mA}$, $T_j=25^{\circ}\text{C}$
		-	11	40		
IQ		-	4.2	6.0	mA	$V_{in}=17\text{V}$, $I_o=0\text{mA}$, $T_j=25^{\circ}\text{C}$
ΔIQ		-	-	0.1	mA	$V_{in}=17\text{V}$, $1\text{mA} \leq I_o \leq 40\text{mA}$ $14\text{V} \leq V_{in} \leq 25\text{V}$, $I_o=40\text{mA}$
		-	-	1.5		
Vn		-	62	-	μV	$10\text{Hz} \leq f \leq 100\text{KHz}$
RR		37	44	-	dB	$15\text{V} \leq V_{in} \leq 25\text{V}$, $I_o=40\text{mA}$, $f=120\text{Hz}$, $T_j=25^{\circ}\text{C}$
VD		-	1.7	-	V	$I_o=100\text{mA}$, $T_j=25^{\circ}\text{C}$

G78L12 (Refer to the test circuits, $T_j=0\sim 125^{\circ}\text{C}$, $I_o=40\text{mA}$, $V_{in}=19\text{V}$, $C_{in}=0.33\mu\text{F}$, $C_o=0.1\mu\text{F}$ unless otherwise specified) (Note1)

Symbol		Min.	Typ.	Max.	Unit	Test Conditions
VO	A-Rank (3%)	11.64	12.0	12.36	V	$V_{in}=19\text{V}$, $I_o=40\text{mA}$, $T_j=25^{\circ}\text{C}$ $14.5\text{V} \leq V_{in} \leq 27\text{V}$, $1\text{mA} \leq I_o \leq 40\text{mA}$ $14.5\text{V} \leq V_{in} \leq V_{max}$, $1\text{mA} \leq I_o \leq 70\text{mA}$ (Note2)
	B-Rank (5%)	11.40	-	12.60		
ΔVO (Line Regulation)		-	25	300	mV	$14.5\text{V} \leq V_{in} \leq 27\text{V}$, $I_o=40\text{mA}$, $T_j=25^{\circ}\text{C}$ $16\text{V} \leq V_{in} \leq 27\text{V}$, $I_o=40\text{mA}$, $T_j=25^{\circ}\text{C}$
		-	20	250		
ΔVO (Load Regulation)		-	25	150	mV	$V_{in}=19\text{V}$, $1\text{mA} \leq I_o \leq 100\text{mA}$, $T_j=25^{\circ}\text{C}$ $V_{in}=19\text{V}$, $1\text{mA} \leq I_o \leq 40\text{mA}$, $T_j=25^{\circ}\text{C}$
		-	12	75		
IQ		-	2.0	6.0	mA	$V_{in}=19\text{V}$, $I_o=0\text{mA}$, $T_j=25^{\circ}\text{C}$
ΔIQ		-	-	0.1	mA	$V_{in}=19\text{V}$, $1\text{mA} \leq I_o \leq 40\text{mA}$ $16\text{V} \leq V_{in} \leq 27\text{V}$, $I_o=40\text{mA}$
		-	-	1.5		
Vn		-	80	-	μV	$10\text{Hz} \leq f \leq 100\text{KHz}$
RR		37	65	-	dB	$15\text{V} \leq V_{in} \leq 25\text{V}$, $I_o=40\text{mA}$, $f=120\text{Hz}$, $T_j=25^{\circ}\text{C}$
VD		-	1.7	-	V	$I_o=100\text{mA}$, $T_j=25^{\circ}\text{C}$
$\Delta\text{Vo} / \Delta\text{Tj}$		-	-1.0	-	$\text{mV}/^{\circ}\text{C}$	$I_o=5\text{mA}$, $0^{\circ}\text{C} \leq T_j \leq 125^{\circ}\text{C}$

G78L15 (Refer to the test circuits, $T_j=0\sim 125^{\circ}\text{C}$, $I_o=40\text{mA}$, $V_{in}=23\text{V}$, $C_{in}=0.33\mu\text{F}$, $C_o=0.1\mu\text{F}$ unless otherwise specified) (Note1)

Symbol		Min.	Typ.	Max.	Unit	Test Conditions
VO	A-Rank (3%)	14.55	15.0	15.45	V	$V_{in}=23\text{V}$, $I_o=40\text{mA}$, $T_j=25^{\circ}\text{C}$ $17.5\text{V} \leq V_{in} \leq 30\text{V}$, $1\text{mA} \leq I_o \leq 40\text{mA}$ $17.5\text{V} \leq V_{in} \leq V_{max}$, $1\text{mA} \leq I_o \leq 70\text{mA}$ (Note2)
	B-Rank (5%)	14.25	-	15.75		
ΔVO (Line Regulation)		-	25	150	mV	$17.5\text{V} \leq V_{in} \leq 30\text{V}$, $I_o=40\text{mA}$, $T_j=25^{\circ}\text{C}$
		-	15	75		$20\text{V} \leq V_{in} \leq 30\text{V}$, $I_o=40\text{mA}$, $T_j=25^{\circ}\text{C}$
ΔVO (Load Regulation)		-	20	150	mV	$V_{in}=23\text{V}$, $1\text{mA} \leq I_o \leq 100\text{mA}$, $T_j=25^{\circ}\text{C}$
		-	25	150		$V_{in}=23\text{V}$, $1\text{mA} \leq I_o \leq 70\text{mA}$, $T_j=25^{\circ}\text{C}$
IQ		-	2.2	6.5	mA	$V_{in}=23\text{V}$, $I_o=0\text{mA}$, $T_j=25^{\circ}\text{C}$
ΔIQ		-	-	0.1	mA	$V_{in}=23\text{V}$, $1\text{mA} \leq I_o \leq 40\text{mA}$
		-	-	1.5		$20\text{V} \leq V_{in} \leq 30\text{V}$, $I_o=40\text{mA}$
Vn		-	90	-	μV	$10\text{Hz} \leq f \leq 100\text{KHz}$
RR		34	63	-	dB	$18.5\text{V} \leq V_{in} \leq 28.5\text{V}$, $I_o=40\text{mA}$, $f=120\text{Hz}$, $T_j=25^{\circ}\text{C}$
VD		-	1.7	-	V	$I_o=100\text{mA}$, $T_j=25^{\circ}\text{C}$
$\Delta\text{Vo} / \Delta\text{Tj}$		-	-1.3	-	$\text{mV}/^{\circ}\text{C}$	$I_o=5\text{mA}$, $0^{\circ}\text{C} \leq T_j \leq 125^{\circ}\text{C}$

G78L18 (Refer to the test circuits, $T_j=0\sim 125^{\circ}\text{C}$, $I_o=40\text{mA}$, $V_{in}=27\text{V}$, $C_{in}=0.33\mu\text{F}$, $C_o=0.1\mu\text{F}$ unless otherwise specified) (Note1)

Symbol		Min.	Typ.	Max.	Unit	Test Conditions
VO	A-Rank (3%)	17.46	18.0	18.54	V	$V_{in}=27\text{V}$, $I_o=40\text{mA}$, $T_j=25^{\circ}\text{C}$ $21\text{V} \leq V_{in} \leq 33\text{V}$, $1\text{mA} \leq I_o \leq 40\text{mA}$ $21\text{V} \leq V_{in} \leq V_{max}$, $1\text{mA} \leq I_o \leq 70\text{mA}$ (Note2)
	B-Rank (5%)	17.10	-	18.9		
ΔVO (Line Regulation)		-	145	300	mV	$21\text{V} \leq V_{in} \leq 33\text{V}$, $I_o=40\text{mA}$, $T_j=25^{\circ}\text{C}$
		-	135	250		$22\text{V} \leq V_{in} \leq 33\text{V}$, $I_o=40\text{mA}$, $T_j=25^{\circ}\text{C}$
ΔVO (Load Regulation)		-	30	170	mV	$V_{in}=27\text{V}$, $1\text{mA} \leq I_o \leq 100\text{mA}$, $T_j=25^{\circ}\text{C}$
		-	15	85		$V_{in}=27\text{V}$, $1\text{mA} \leq I_o \leq 40\text{mA}$, $T_j=25^{\circ}\text{C}$
IQ		-	2.0	6.0	mA	$V_{in}=27\text{V}$, $I_o=0\text{mA}$, $T_j=25^{\circ}\text{C}$
ΔIQ		-	-	0.1	mA	$V_{in}=27\text{V}$, $1\text{mA} \leq I_o \leq 40\text{mA}$
		-	-	1.5		$21\text{V} \leq V_{in} \leq 33\text{V}$, $I_o=40\text{mA}$
Vn		-	150	-	μV	$10\text{Hz} \leq f \leq 100\text{KHz}$
RR		34	48	-	dB	$23\text{V} \leq V_{in} \leq 33\text{V}$, $I_o=40\text{mA}$, $f=120\text{Hz}$, $T_j=25^{\circ}\text{C}$
VD		-	1.7	-	V	$I_o=100\text{mA}$, $T_j=25^{\circ}\text{C}$
$\Delta\text{Vo} / \Delta\text{Tj}$		-	-1.8	-	$\text{mV}/^{\circ}\text{C}$	$I_o=5\text{mA}$, $0^{\circ}\text{C} \leq T_j \leq 125^{\circ}\text{C}$

G78L24 (Refer to the test circuits, $T_j=0\sim 125^{\circ}\text{C}$, $I_o=40\text{mA}$, $V_{in}=33\text{V}$, $C_{in}=0.33\mu\text{F}$, $C_o=0.1\mu\text{F}$ unless otherwise specified) (Note1)

Symbol		Min.	Typ.	Max.	Unit	Test Conditions
VO	A-Rank (3%)	23.28	24.0	24.72	V	$V_{in}=33\text{V}$, $I_o=40\text{mA}$, $T_j=25^{\circ}\text{C}$ $27\text{V} \leq V_{in} \leq 38\text{V}$, $1\text{mA} \leq I_o \leq 40\text{mA}$ $27\text{V} \leq V_{in} \leq V_{max}$, $1\text{mA} \leq I_o \leq 70\text{mA}$ (Note2)
	B-Rank (5%)	22.80	-	25.20		
ΔVO (Line Regulation)		-	160	300	mV	$27\text{V} \leq V_{in} \leq 38\text{V}$, $I_o=40\text{mA}$, $T_j=25^{\circ}\text{C}$
		-	150	250		$28\text{V} \leq V_{in} \leq 38\text{V}$, $I_o=40\text{mA}$, $T_j=25^{\circ}\text{C}$
ΔVO (Load Regulation)		-	40	200	mV	$V_{in}=33\text{V}$, $1\text{mA} \leq I_o \leq 100\text{mA}$, $T_j=25^{\circ}\text{C}$
		-	20	100		$V_{in}=33\text{V}$, $1\text{mA} \leq I_o \leq 40\text{mA}$, $T_j=25^{\circ}\text{C}$
IQ		-	2.2	6.0	mA	$V_{in}=33\text{V}$, $I_o=0\text{mA}$, $T_j=25^{\circ}\text{C}$
ΔIQ		-	-	0.1	mA	$V_{in}=33\text{V}$, $1\text{mA} \leq I_o \leq 40\text{mA}$
		-	-	1.5		$27\text{V} \leq V_{in} \leq 38\text{V}$, $I_o=40\text{mA}$
Vn		-	200	-	μV	$10\text{Hz} \leq f \leq 100\text{KHz}$
RR		34	45	-	dB	$27\text{V} \leq V_{in} \leq 38\text{V}$, $I_o=40\text{mA}$, $f=120\text{Hz}$, $T_j=25^{\circ}\text{C}$
VD		-	1.7	-	V	$I_o=100\text{mA}$, $T_j=25^{\circ}\text{C}$
$\Delta\text{Vo} / \Delta\text{Tj}$		-	-2.0	-	$\text{mV}/^{\circ}\text{C}$	$I_o=5\text{mA}$, $0^{\circ}\text{C} \leq T_j \leq 125^{\circ}\text{C}$

Note1: The Maximum steady state usable output current is dependent on input voltage, heat sinking, lead length of the package and copper of PCB. The data above represent pulse test conditions with junction temperatures specified at the initiation of test.

Note2: Power dissipation < 0.625W

Typical Application

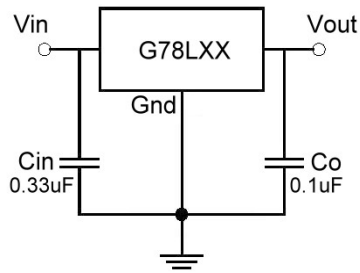

Characteristics Curve

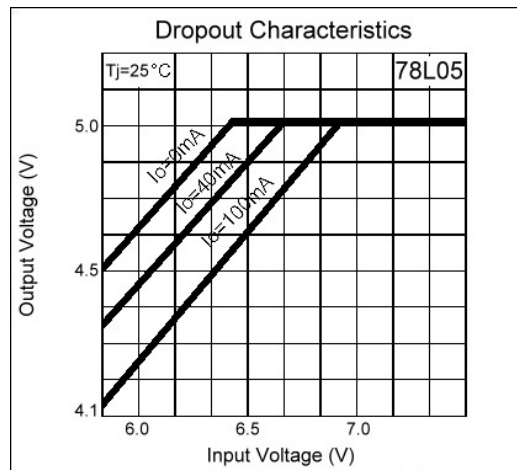
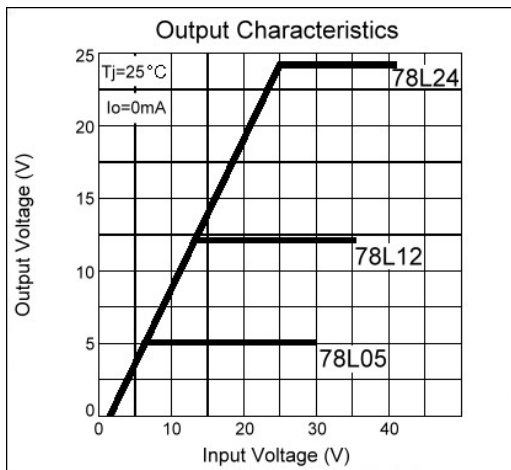
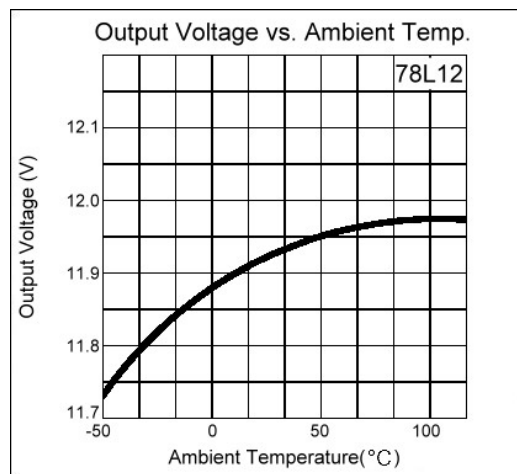
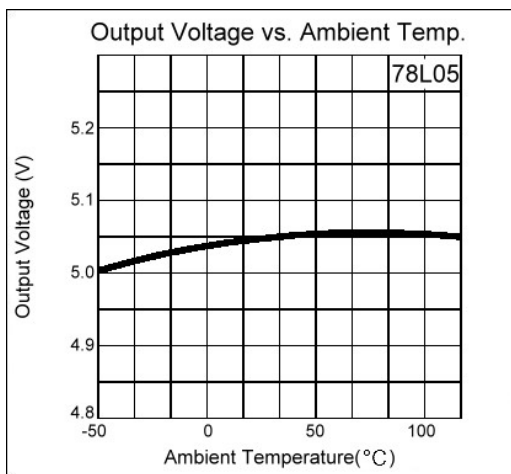

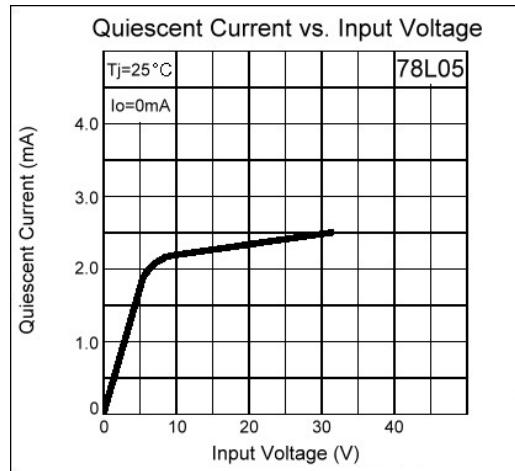
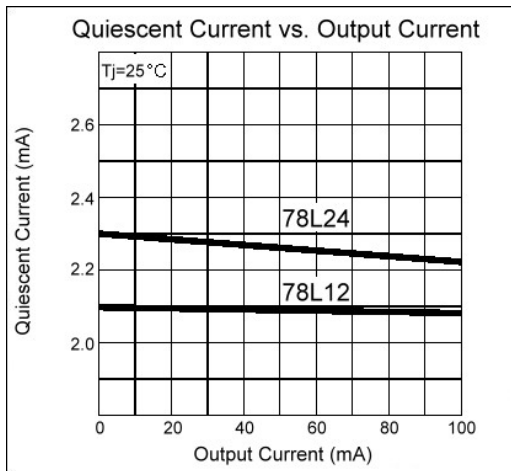

Important Notice:

- All rights are reserved. Reproduction in whole or in part is prohibited without the prior written approval of GTM.
- GTM reserves the right to make changes to its products without notice.
- GTM semiconductor products are not warranted to be suitable for use in life-support Applications, or systems.
- GTM assumes no liability for any consequence of customer product design, infringement of patents, or application assistance.

Head Office And Factory:

- **Taiwan:** No. 17-1 Tatung Rd. Fu Kou Hsin-Chu Industrial Park, Hsin-Chu, Taiwan, R. O. C.
- TEL : 886-3-597-7061 FAX : 886-3-597-9220, 597-0785
- **China:** (201203) No.255, Jang-Jiang Tsai-Lueng RD. , Pu-Dung-Hsin District, Shang-Hai City, China
- TEL : 86-21-5895-7671 ~ 4 FAX : 86-21-38950165