

DATA SHEET

TEA5757; TEA5759 **Self Tuned Radio (STR)**

Product specification
Supersedes data of 1996 Jan 09
File under Integrated Circuits, IC01

1999 Aug 26

Self Tuned Radio (STR)

TEA5757; TEA5759

FEATURES

- The tuning system has an optimized IC partitioning both from application (omitting interferences) and flexibility (removable front panel option) point of view: the tuning synthesizer is on-chip with the radio
- The tuning quality is superior and requires no IF-counter for stop-detection; it is insensitive to ceramic filter tolerances
- In combination with the microcontroller, fast, low-power operation of preset mode, manual-search, auto-search and auto-store are possible
- The local (internal) controller function facilitates reduced and simplified microcontroller software
- The high integration level (radio and tuning synthesizer on one chip) means fewer external components with regard to the communication between the radio and the microcontroller (90% less components compared to the digital tuning application of a radio IC with external PLL tuning function) and a simple and small printed-circuit board
- There will be no application considerations for the tuning system, with regards to quality and high integration level, since there will be no external 110 MHz buffers, loop filter or false lock elimination
- The inherent FUZZY LOGIC behaviour of the Self Tuned Radio (STR), which mimics hand tuning, yields a potentially fast yet reliable tuning operation
- The level of the incoming signal at which the radio must lock is software programmable
- Two programmable ports

- High selectivity with distributed IF gain
- Soft mute
- Signal dependent stereo-blend
- High impedance MOSFET input on AM
- Wide supply voltage range of 2.5 to 12 V
- Low current consumption 18 mA at AM and FM (including tuning synthesizer)
- High input sensitivity
- Low output distortion
- Due to the new tuning concept, the tuning is independent of the channel spacing.

GENERAL DESCRIPTION

The TEA5757; TEA5759 is a 44-pin integrated AM/FM stereo radio circuit including a novel tuning concept. The radio part is based on the TEA5712.

The TEA5757 is used in FM-standards in which the local oscillator frequency is above the radio frequency (e.g. European and American standards).

The TEA5759 is the version in which the oscillator frequency is below the radio frequency (e.g. Japanese standard).

The new tuning concept combines the advantages of hand tuning with electronic facilities and features. User 'intelligence' is incorporated into the tuning algorithm and an improvement of the analog signal processing is used for the AFC function.

ORDERING INFORMATION

TYPE NUMBER	PACKAGE		
	NAME	DESCRIPTION	VERSION
TEA5757H	QFP44	plastic quad flat package; 44 leads (lead length 1.3 mm); body 10 × 10 × 1.75 mm	SOT307-2
TEA5759H			

Self Tuned Radio (STR)

TEA5757; TEA5759

QUICK REFERENCE DATA

SYMBOL	PARAMETER	CONDITIONS	MIN.	TYP.	MAX.	UNIT
V_{CC1}	supply voltage		2.5	–	12	V
V_{CC2}	supply voltage for tuning		–	–	12	V
V_{tune}	tuning voltage		0.7	–	$V_{CC2} - 0.75$	V
I_{CC1}	supply current	AM mode	12	15	18	mA
		FM mode	13	16	19	mA
I_{DD}	supply current	AM mode	–	3.3	–	mA
		FM mode	–	2.7	–	mA
I_{CC2}	supply current for tuning in preset mode (band-end to band-end)		–	–	800	μ A
T_{amb}	ambient temperature		–15	–	+60	$^{\circ}$ C
AM performance; note 1						
V_{10}	AF output voltage	$V_{i1} = 5$ mV	36	45	70	mV
V_{i1}	RF sensitivity input voltage	$(S+N)/N = 26$ dB	40	55	70	μ V
THD	total harmonic distortion	$V_{i1} = 1$ mV	–	0.8	2.0	%
FM performance; note 2						
V_{10}	AF output voltage	$V_{i5} = 1$ mV	40	48	57	mV
V_{i5}	RF limiting sensitivity	V_{10} at –3 dB; V_{10} is 0 dB at $V_{i5} = 1$ mV	0.4	1.2	3.8	μ V
THD	total harmonic distortion	IF filter SFE10.7MS3A20K-A	–	0.3	0.8	%
MPX performance; note 3						
α_{CS}	channel separation		26	30	–	dB

Notes

- $V_{CC1} = 3$ V; $V_{CC2} = 12$ V; $V_{DDD} = 3$ V; $f_i = 1$ MHz; $m = 0.3$; $f_m = 1$ kHz; measured in Fig.9 with S1 in position A and S2 in position B; V_n refers to pin voltages; $V_{i(n)}$ refers to test circuit (see Fig.9).
- $V_{CC1} = 3$ V; $V_{CC2} = 12$ V; $V_{DDD} = 3$ V; $f_i = 100$ MHz; $\Delta f_m = 22.5$ kHz; $f_m = 1$ kHz; measured in Fig.9 with S2, S3 and S5 in position A; V_n refers to pin voltages; $V_{i(n)}$ refers to test circuit (see Fig.9).
- $V_{CC1} = 3$ V; $V_{CC2} = 12$ V; $V_{DDD} = 3$ V; $V_{i3(L+R)} = 155$ mV; $V_{pilot} = 15.5$ mV; $f_i = 1$ kHz; measured in Fig.9 with S2 and S3 in position B.

Self Tuned Radio (STR)

TEA5757; TEA5759

BLOCK DIAGRAM

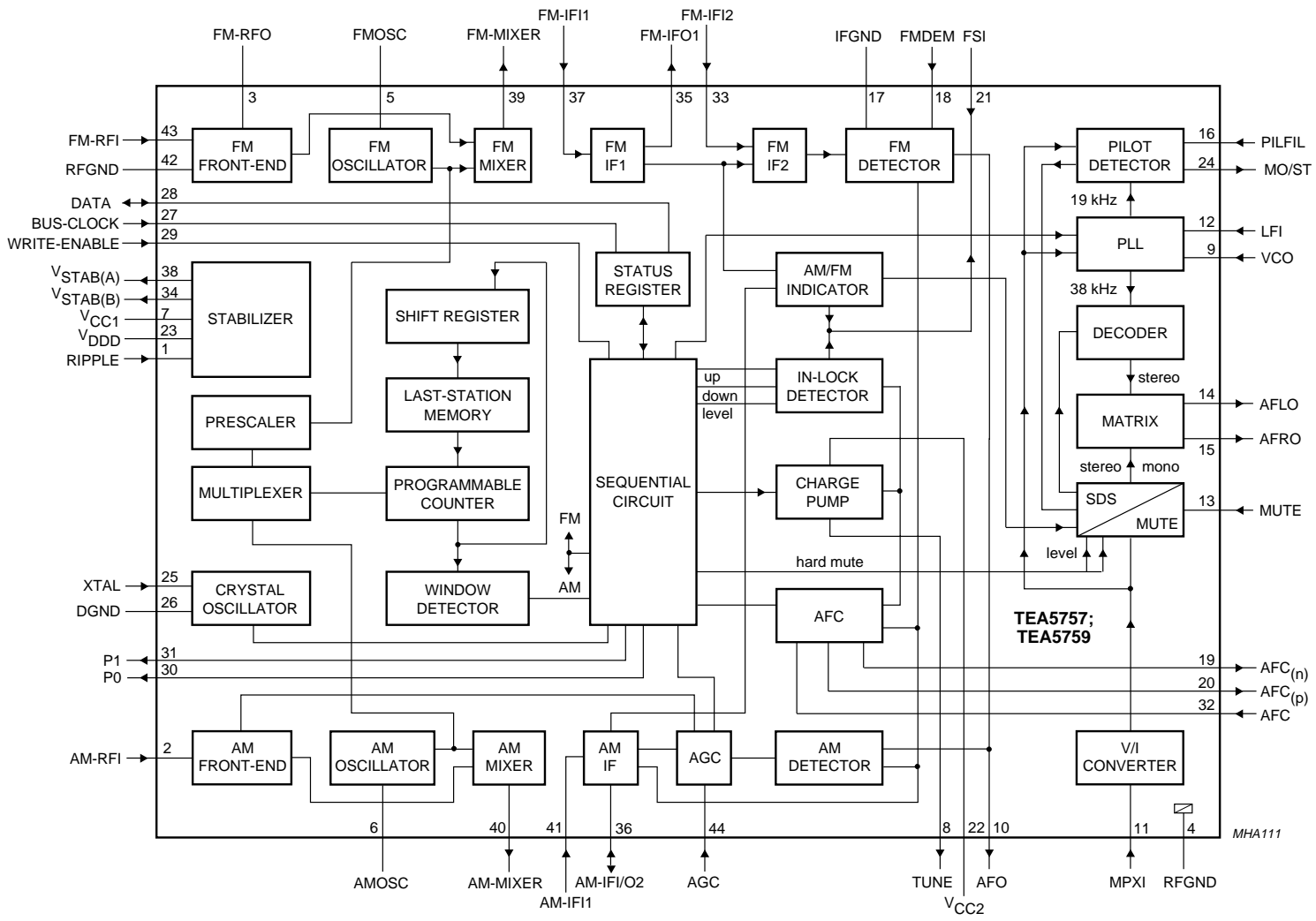

Fig.1 Block diagram.

Self Tuned Radio (STR)

TEA5757; TEA5759

PINNING

SYMBOL	PIN	DESCRIPTION
RIPPLE	1	ripple capacitor input
AM-RFI	2	AMRF input
FM-RFO	3	parallel tuned FMRF circuit to ground
RFGND	4	RF ground and substrate
FMOSC	5	parallel tuned FM-oscillator circuit to ground
AMOSC	6	parallel tuned AM-oscillator circuit to ground
V _{CC1}	7	supply voltage
TUNE	8	tuning current output
VCO	9	voltage controlled oscillator input
AFO	10	AM/FM AF output (output impedance typical 5 k Ω)
MPXI	11	stereo decoder input (input impedance typical 150 k Ω)
LFI	12	loop-filter input
MUTE	13	mute input
AFLO	14	left channel output (output impedance typical 4.3 k Ω)
AFRO	15	right channel output (output impedance typical 4.3 k Ω)
PILFIL	16	pilot detector filter input
IFGND	17	ground of IF, detector and MPX stage
FMDEM	18	ceramic discriminator input
AFC _(n)	19	AFC negative output
AFC _(p)	20	AFC positive output
FSI	21	field-strength indicator
V _{CC2}	22	supply voltage for tuning
V _{DDD}	23	digital supply voltage
MO/ST	24	mono/stereo and tuning indication output
XTAL	25	crystal input
DGND	26	digital ground
BUS-CLOCK	27	bus-clock input
DATA	28	bus data input/output
WRITE-ENABLE	29	bus write-enable input
P0	30	programmable output port (P0)
P1	31	programmable output port (P1)
AFC	32	450 kHz LC-circuit
FM-IFI2	33	FMIF input 2 (input impedance typical 330 Ω)
V _{STAB(B)}	34	internal stabilized supply voltage (B)
FM-IFO1	35	FMIF output 1 (output impedance typical 330 Ω)
AM-IFI/O2	36	input/output to IF-Tank (IFT); output: current source
FM-IFI1	37	FMIF input 1 (input impedance typical 330 Ω)
V _{STAB(A)}	38	internal stabilized supply voltage (A)
FM-MIXER	39	ceramic filter output (output impedance typical 330 Ω)
AM-MIXER	40	open-collector output to IFT

Self Tuned Radio (STR)

TEA5757; TEA5759

SYMBOL	PIN	DESCRIPTION
AM-IF1	41	IFT or ceramic filter input (input impedance typical 3 kΩ)
RFGND	42	FMRF ground
FM-RFI	43	FMRF aerial input (input impedance typical 40 Ω)
AGC	44	AGC capacitor input

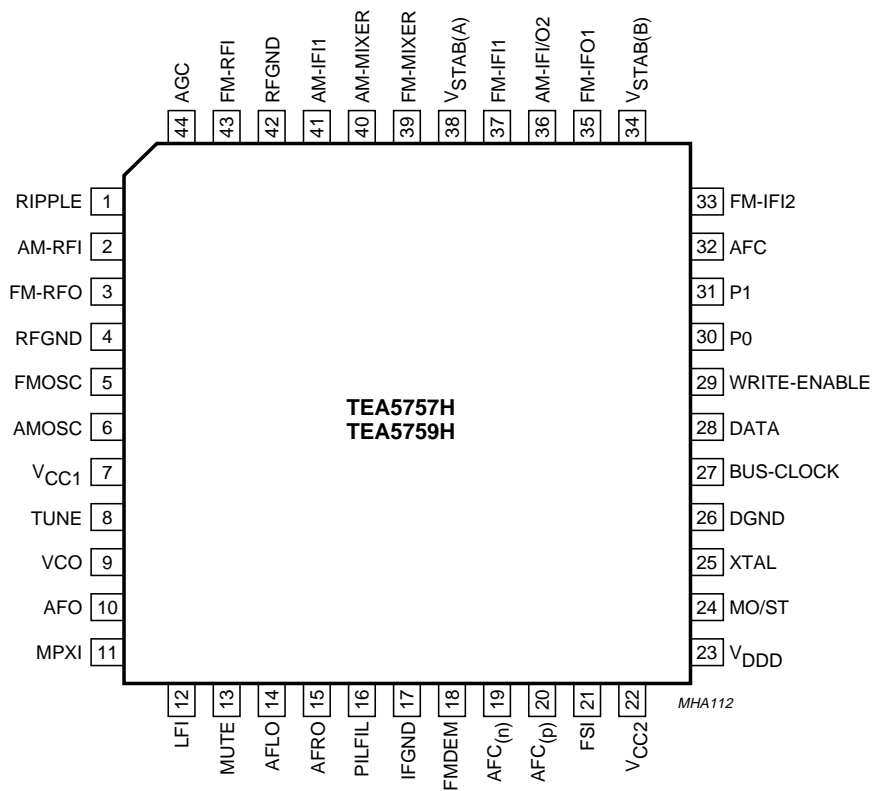

Fig.2 Pin configuration.

Self Tuned Radio (STR)

TEA5757; TEA5759

FUNCTIONAL DESCRIPTION

The TEA5757; TEA5759 is an integrated AM/FM stereo radio circuit including digital tuning and control functions.

The radio

The AM circuit incorporates a double balanced mixer, a one-pin low-voltage oscillator (up to 30 MHz) and is designed for distributed selectivity.

The AM input is designed to be connected to the top of a tuned circuit. AGC controls the IF amplification and for large signals it lowers the input impedance of the AM front-end.

The first AM selectivity can be an IF-Tank (IFT) as well as an IFT combined with a ceramic filter; the second one is an IFT.

The FM circuit incorporates a tuned RF stage, a double balanced mixer, a one-pin oscillator and is designed for distributed IF ceramic filters. The FM quadrature detector uses a ceramic resonator (or LC).

The PLL stereo decoder incorporates a signal dependent stereo-blend circuit and a soft-mute circuit.

Tuning

The tuning concept of the Self Tuned Radio (STR) is based on FUZZY LOGIC: it mimics hand tuning (hand tuning is a combination of coarse and fine tuning to the qualitatively best frequency position). As a consequence the tuning system is very fast.

The tuning algorithm, which is controlled by the sequential circuit (see Fig.1), is completely integrated; so there are only a few external components needed.

The bus and the microcontroller can be kept very simple. The bus only consists of three wires (BUS-CLOCK, DATA and WRITE-ENABLE). The microcontroller must basically give two instructions:

- Preset operation
- Search operation.

PRESET OPERATION

In preset mode, the microcontroller has to load information such as frequency band, frequency and mono/stereo. This information has to be sent via the bus to the STR.

The internal algorithm controls the tuning sequence as follows:

1. The information is loaded into the shift register, the last-station memory and the counter.

2. The Automatic Frequency Control (AFC) is switched off.
3. The counter starts counting the frequency and the tuning voltage is varied until the desired frequency roughly equals the real frequency.
4. The AFC is then switched on and the counter is switched off.
5. The real frequency is more precisely tuned to the desired frequency.

After the AFC has tuned the real frequency to the desired frequency an in-lock signal can be generated. In order to get a reliable in-lock signal, there are two parameters measured: the field strength and the S-curve. The field strength indicates the strength of the station and by looking at the S-curve the system can distinguish false in-locks from real in-locks (false in-locks occur on the wrong slope of the S-curve).

In the event of fading or pulling the in-lock signal becomes logic 0 and the synthesizer will be switched on again and the algorithm will be repeated.

SEARCH OPERATION

During a search operation, the only action the microcontroller has to take is: sending the desired band plus the direction and the search sensitivity level to the STR. The search operation is performed by the charge pump until an in-lock signal is generated (combination of measuring the field strength and the S-curve). The AFC then fine tunes to the station. The frequency belonging to the found station will be counted by the counter and written into the last-station memory and the shift register of the counter. At this time the frequency is available in the shift register and can be read by the microcontroller.

The microcontroller decides whether the frequency is within the desired frequency band. If so, this frequency can be stored under a preset and if not, a new search action should be started.

To ensure that the search function operates correctly under all conditions the following search sequence must be applied:

- Store the current frequency in the memory
- Issue the search command
- Wait for data valid and read the new frequency
- If the new frequency is the same as the stored frequency, issue a pre-set step (e.g. 50 kHz) and start the search sequence again.

Self Tuned Radio (STR)

TEA5757; TEA5759

Description of the bus

The TEA5757; TEA5759 radio has a bus which consists of three wires, as shown in Table 1.

Table 1 Bus signals

SIGNAL	DESCRIPTION	PIN
BUS-CLOCK	software driven clock input	27
DATA	data input/output	28
WRITE-ENABLE	write/read input	29

These three signals, together with the mono/stereo pin (MO/ST; pin 24), communicate with the microcontroller. The mono/stereo indicator has two functions, which are controlled by the BUS-CLOCK, as shown in Table 2.

Table 2 Bus-clock functions

BUS-CLOCK	MO/ST (PIN 24)	RESULT
LOW	LOW	stereo
LOW	HIGH	mono
HIGH	LOW	tuned
HIGH	HIGH	not tuned

The TEA5757; TEA5759 has a 25-bit shift register; see Table 3 for an explanation of the shift register bits.

If in search mode no transmitter can be found, all frequency bits of the shift register are set to logic 0.

The bus protocol is depicted in Figs 3 and 4.

Table 3 Explanation of the shift register bits

BIT	DESCRIPTION	LOGIC STATE	RESULT
S.24 (MSB)	search start/end	0	after a search when a station is found or after a preset
		1	during the search action
D.23	search up/down	0	indicates if the radio has to search down
		1	indicates if the radio has to search up
M.22	mono/stereo	0	stereo is allowed
		1	mono is required (radio switched to forced mono)
B0.21	band	see Table 4	selects FM/MW/LW/SW band
B1.20			
P0.19	port	note 1	user programmable bits which e.g. can be used as band switch driver
P1.18			
S0.17	search-level of station	see Table 5	determines the locking field strength during an automatic search, automatic store or manual search
S1.16			
15	dummy	–	buffer
F.14 to F.0 (LSB)	frequency	–	determine the tuning frequency of the radio; see Table 6 for the bit values

Note

- The output pins 30 and 31 can drive currents up to 5 mA; bits P0.19 and P1.18 control the output voltage of the control pins P0 (pin 30) and P1 (pin 31):
 - Bit P0.19 LOW sets P0 (pin 30) to LOW.
 - Bit P0.19 HIGH sets P0 (pin 30) to HIGH.
 - Bit P1.18 LOW sets P1 (pin 31) to LOW.
 - Bit P1.18 HIGH sets P1 (pin 31) to HIGH.

Self Tuned Radio (STR)

TEA5757; TEA5759

Table 4 Truth table for bits B0.21 and B1.20

B0.21	B1.20	BAND SELECT
0	0	FM
0	1	MW
1	0	LW
1	1	SW

Table 5 Truth table for bits S1.16 and S0.17

S1.16	S0.17	SIGNAL RECEPTION	
		FM (μV)	AM (μV)
0	0	>5	>28
0	1	>10	>40
1	0	>30	>63
1	1	>150	>1000

Table 6 Values for bits F.14 to F.0

BIT	BIT VALUE	FM VALUE ⁽¹⁾ (kHz)	AM VALUE ⁽²⁾ (kHz)
F.14	2^{14}	–	16384
F.13	2^{13}	102400	8192
F.12	2^{12}	51200	4096
F.11	2^{11}	25600	2048
F.10	2^{10}	12800	1024
F.9	2^9	6400	512
F.8	2^8	3200	256
F.7	2^7	1600	128
F.6	2^6	800	64
F.5	2^5	400	32
F.4	2^4	200	16
F.3	2^3	100	8
F.2	2^2	50	4
F.1	2^1	25	2
F.0	2^0	12.5	1

Notes

- FM value of the affected oscillators:
 - FM VALUE = FMRF + FMIF (for TEA5757).
 - FM VALUE = FMRF – FMIF (for TEA5759).
- AM value of the affected oscillators:
AM VALUE = AMRF + AMIF.

Self Tuned Radio (STR)

TEA5757; TEA5759

READING DATA

While WRITE-ENABLE is LOW data can be read by the microcontroller. At a rising edge of the BUS-CLOCK, data is shifted out of the register. This data is available from the point where the BUS-CLOCK is HIGH until the next rising edge of the BUS-CLOCK occurs (see Fig.3).

To read the entire shift register 24 clock pulses are necessary.

WRITING DATA

While WRITE-ENABLE is HIGH the microcontroller can transmit data to the TEA5757; TEA5759 (hard mute is active). At a rising edge of the BUS-CLOCK, the register shifts and accepts one bit into LSB. At clock LOW the microcontroller writes data (see Fig.4).

To write the entire shift register 25 clock pulses are necessary.

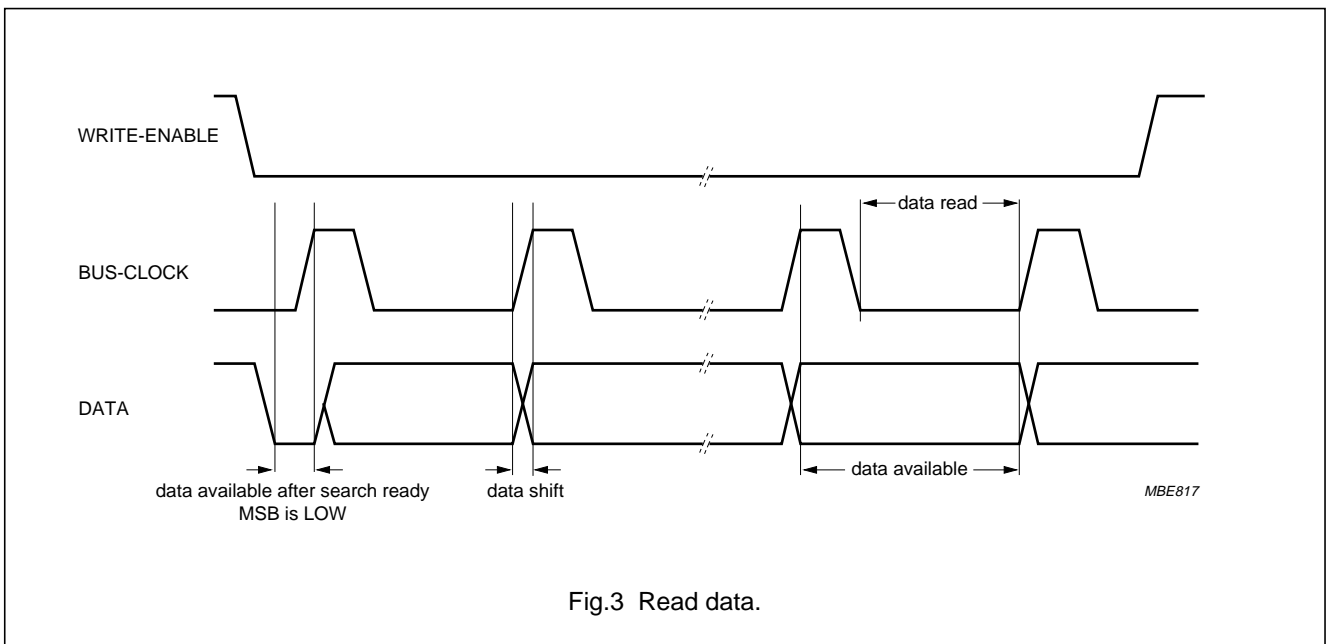

Fig.3 Read data.

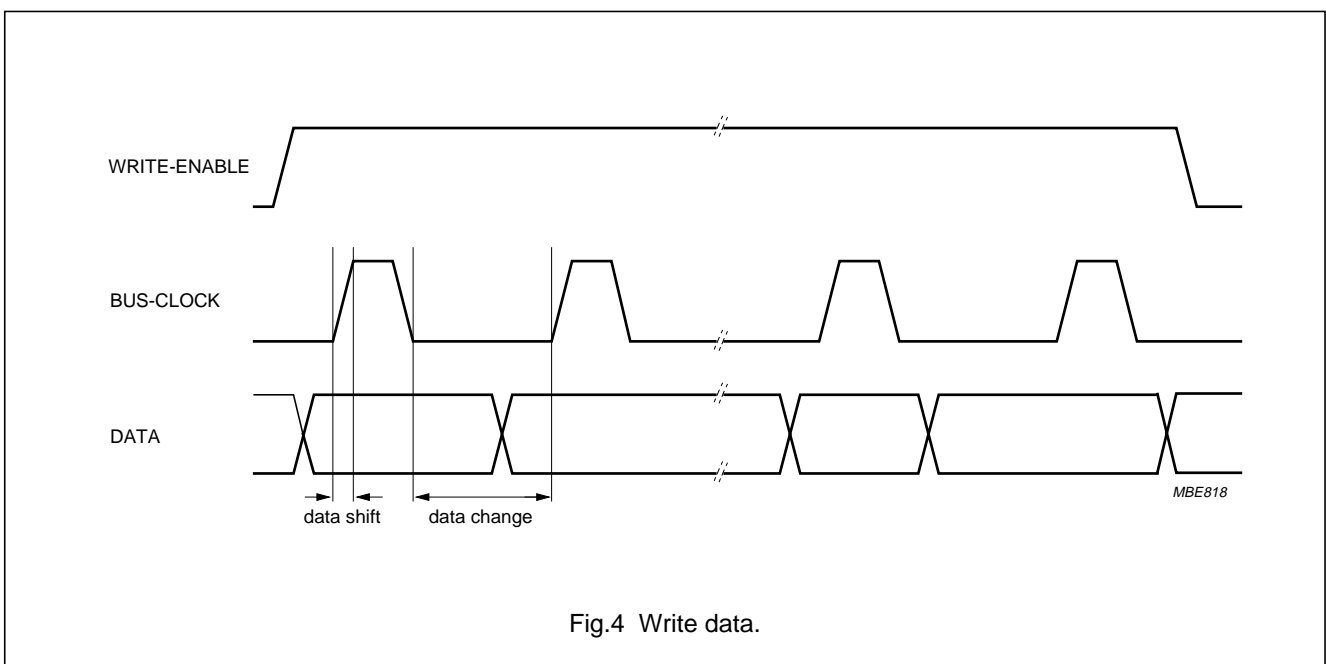

Fig.4 Write data.

Self Tuned Radio (STR)

TEA5757; TEA5759

BUS TIMING

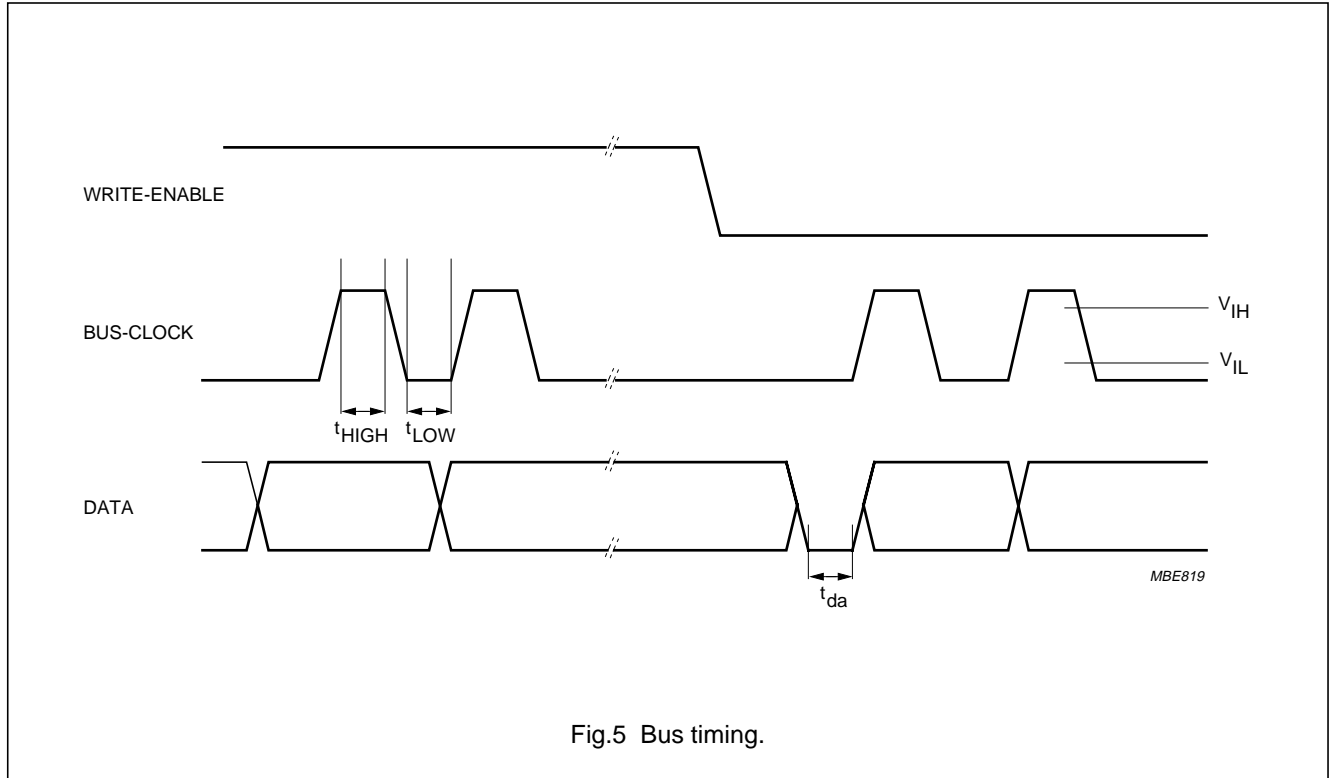

Fig.5 Bus timing.

Table 7 Digital inputs

SYMBOL	PARAMETER	MIN.	MAX.	UNIT
Digital inputs				
V_{IH}	HIGH-level input voltage	1.4	–	V
V_{IL}	LOW-level input voltage	–	0.6	V
Timing				
f_{clk}	clock input frequency	–	300	kHz
t_{HIGH}	clock HIGH time	1.67	–	μ s
t_{LOW}	clock LOW time	1.67	–	μ s
t_{da}	shift register available after 'search ready'	–	14	μ s

Self Tuned Radio (STR)

TEA5757; TEA5759

LIMITING VALUES

In accordance with the Absolute Maximum Rating System (IEC 134).

SYMBOL	PARAMETER	CONDITIONS	MIN.	MAX.	UNIT
V_{CC1}	supply voltage		0	13.2	V
P_{tot}	total power dissipation	$T_{amb} = 70\text{ °C}$	–	250	mW
T_{stg}	storage temperature		–65	+150	°C
T_{amb}	ambient temperature		–15	+60	°C
T_j	junction temperature		–15	+150	°C
V_{es}	electrostatic handling voltage for all pins	note 1	–	±200	V

Note

1. Charge device model; equivalent to discharging a 200 pF capacitor via a 0 Ω series resistor.

THERMAL CHARACTERISTICS

SYMBOL	PARAMETER	CONDITIONS	VALUE	UNIT
$R_{th(j-a)}$	thermal resistance from junction to ambient	in free air	65	K/W

Self Tuned Radio (STR)

TEA5757; TEA5759

CHARACTERISTICS

$V_{CC1} = 3\text{ V}$; $T_{amb} = 25\text{ }^{\circ}\text{C}$; unless otherwise specified.

SYMBOL	PARAMETER	CONDITIONS	MIN.	TYP.	MAX.	UNIT
V_{CC1}	supply voltage		2.5	–	12	V
V_{CC2}	supply voltage for tuning		–	–	12	V
V_{DDD}	supply voltage for digital part		2.5	–	12	V
V_{tune}	tuning voltage		0.7	–	$V_{CC2} - 0.75$	V
I_{CC2}	supply current for tuning in preset mode (band-end to band-end)		–	–	800	μA
$f_{\text{BUS-CLOCK(max)}}$	maximum BUS-CLOCK frequency		–	–	300	kHz
I_{CC1}	current consumption during acquisition of V_{CC1}	AM mode	12	15	18	mA
		FM mode	12.5	15.5	18.5	mA
I_{DD}	current consumption during acquisition of I_{DD}	AM mode	–	4.8	–	mA
		FM mode	–	5.5	–	mA
I_{CC1}	current consumption after acquisition of V_{CC1}	AM mode	12	15	18	mA
		FM mode	13	16	19	mA
I_{DD}	current consumption after acquisition of I_{DD}	AM mode	–	3.3	–	mA
		FM mode	–	2.7	–	mA
t_{search}	synthesizer auto-search time for empty band	FM mode	–	–	10	s
t_{acq}	synthesizer preset acquisition time between two band limits	FM	–	100	–	ms
		MW	–	100	–	ms
		LW	–	200	–	ms
		SW	–	500	–	ms
f_{band}	frequency band range of the synthesizer	AM mode	0.144	–	30	MHz
		FM mode	50	–	150	MHz
Δf_{FM}	AFC inaccuracy of FM		–	–	1	kHz
Δf_{AM}	AFC inaccuracy of AM		–	–	100	Hz
$I_{P0(\text{sink})}$	sink current of software programmable output P0	$V_{30} = 3\text{ V}$	4	6	–	mA
$I_{P1(\text{sink})}$	sink current of software programmable output P1	$V_{31} = 3\text{ V}$	4	6	–	mA
$I_{P0(\text{source})}$	source current of software programmable output P0	$V_{30} = 0\text{ V}$	5	9	–	mA
$I_{P1(\text{source})}$	source current of software programmable output P1	$V_{31} = 0\text{ V}$	5	9	–	mA

Self Tuned Radio (STR)

TEA5757; TEA5759

AM CHARACTERISTICS

Input frequency $f_i = 1$ MHz; $m = 0.3$; $f_m = 1$ kHz; measured in test circuit at pin 10 (see Fig.9); S2 in position B; V_{i1} measured at input of matching network at pin 2; matching network adjusted to maximum output voltage at low input level; V_n refers to pin voltages; $V_{i(n)}$ refers to test circuit (see Fig.9); unless otherwise specified.

SYMBOL	PARAMETER	CONDITIONS	MIN.	TYP.	MAX.	UNIT
V_{10}	AF output voltage	$V_{i1} = 5$ mV	36	45	70	mV
V_{i1}	RF sensitivity input voltage	$(S+N)/N = 26$ dB	40	55	70	μ V
V_{i1}	large signal voltage handling capacity	$m = 0.8$; THD $\leq 8\%$	150	300	–	mV
PSRR	power supply ripple rejection $\left(\frac{V_{10}}{\Delta V_7}\right)$	$\Delta V_7 = 100$ mV (RMS); 100 Hz; $V_7 = 3.0$ V	–	–47	–	dB
I_i	input current (pin 2)	$V_{44} = 0.2$ V	–	0	–	μ A
C_i	input capacitance (pin 2)	$V_{44} = 0.2$ V	–	–	4	pF
G_c	front-end conversion gain	$V_{44} = 0.2$ V	5	10	14	dB
		$V_{44} = 0.9$ V	–26	–14	0	dB
$(S+N)/N$	signal plus noise-to-noise ratio		–	50	–	dB
THD	total harmonic distortion	$V_{i1} = 1$ mV	–	0.8	2.0	%
α_{450}	IF suppression	$V_{10} = 30$ mV	–	56	–	dB

FM CHARACTERISTICS

Input frequency $f_i = 100$ MHz; $\Delta f = 22.5$ kHz; $f_m = 1$ kHz; measured in test circuit (see Fig.9) at pin 10; S2 in position B; V_n refers to pin voltages; $V_{i(n)}$ refers to test circuit (see Fig.9); unless otherwise specified.

SYMBOL	PARAMETER	CONDITIONS	MIN.	TYP.	MAX.	UNIT
V_{10}	AF output voltage	$V_{i5} = 1$ mV	40	48	57	mV
V_{i5}	RF sensitivity input voltage	$(S+N)/N = 26$ dB	1	2	3.8	μ V
V_{i5}	RF limiting sensitivity	V_{10} at -3 dB; V_{10} is 0 dB at $V_{i5} = 1$ mV	0.4	1.2	3.8	μ V
V_{i5}	large signal voltage handling capacity	THD $< 5\%$	–	500	–	mV
PSRR	power supply ripple rejection $\left(\frac{V_{10}}{\Delta V_7}\right)$	$\Delta V_7 = 100$ mV (RMS); 100 Hz; $V_7 = 3.0$ V	–44	–	–	dB
G_c	front-end conversion gain $\left(\frac{V_{37}}{V_{i5}}\right)$		12	18	22	dB
$(S+N)/N$	signal plus noise-to-noise ratio	$V_{i5} = 1$ mV	–	62	–	dB
THD	total harmonic distortion	IF filter SFE10.7MS3A20K-A	–	0.3	0.8	%

Self Tuned Radio (STR)

TEA5757; TEA5759

STEREO DECODER CHARACTERISTICS

$V_{i3(L+R)} = 155 \text{ mV}$; $V_{\text{pilot}} = 15.5 \text{ mV}$; $f = 1 \text{ kHz}$; apply unmodulated RF signal of 100 mV to front-end to set radio to maximum channel separation; soft mute off (S4 in position A); unless otherwise specified.

SYMBOL	PARAMETER	CONDITIONS	MIN.	TYP.	MAX.	UNIT
$V_{14/15}$	AF output voltage		–	160	–	mV
$V_{\text{pilot}(s)}$	switch to stereo		–	8	12	mV
$V_{\text{pilot}(m)}$	switch to mono		2	5	–	mV
$V_{\text{AF-L}}/V_{i3}$	MPX voltage gain		–1.5	–	+1.5	dB
(S+N)/N	signal plus noise-to-noise ratio	$V_{\text{pilot}} = 15.5 \text{ mV}$ (stereo)	–	74	–	dB
THD	total harmonic distortion		–	0.5	1.0	%
α_{cs}	channel separation		26	30	–	dB
α_{19}	carrier and harmonic suppression	19 kHz (200 mV) = 0 dB	27	32	–	dB
α_{38}		38 kHz	16	21	–	dB
α	stereo-blend	$V_{i5} = 200 \mu\text{V}$	22	30	–	dB
		$V_{i5} = 20 \mu\text{V}$	–	1	2	dB
mute(s)	soft mute depth	$V_{i5} = 3 \mu\text{V}$; $V_{14} = V_{15}$	–1	0	–	dB
		$V_{i5} = 1 \mu\text{V}$; $V_{14} = V_{15}$	–	–6	–10	dB

TUNING CHARACTERISTICS

SYMBOL	PARAMETER	CONDITIONS	MIN.	TYP.	MAX.	UNIT
V_{FM}	FM voltage levels	$\alpha_{-3 \text{ dB}}$ -point at $V_{i5} = 2 \mu\text{V}$				
	high (auto-store/search)	$S_0 = 1$; $S_1 = 1$	60	150	500	μV
	medium (auto-store/search)	$S_0 = 0$; $S_1 = 1$	10	30	55	μV
	low (auto-store/search)	$S_0 = 1$; $S_1 = 0$	4	10	20	μV
V_{AM}	AM voltage levels	$\alpha_{-3 \text{ dB}}$ -point at $V_{i5} = 2 \mu\text{V}$				
	high (auto-store/search)	$S_0 = 1$; $S_1 = 1$	400	1000	2500	μV
	medium (auto-store/search)	$S_0 = 0$; $S_1 = 1$	50	63	80	μV
	low (auto-store/search)	$S_0 = 1$; $S_1 = 0$	32	40	50	μV
$V_{\text{AFC(off)}}$	AFC voltage off mode	$\alpha_{-3 \text{ dB}}$ -point at $V_{i5} = 2 \mu\text{V}$				
		FM mode	–	3	–	μV
		AM mode	–	25	–	μV
mute(h)	hard mute depth	WRITE-ENABLE = HIGH	–	60	–	dB

Self Tuned Radio (STR)

TEA5757; TEA5759

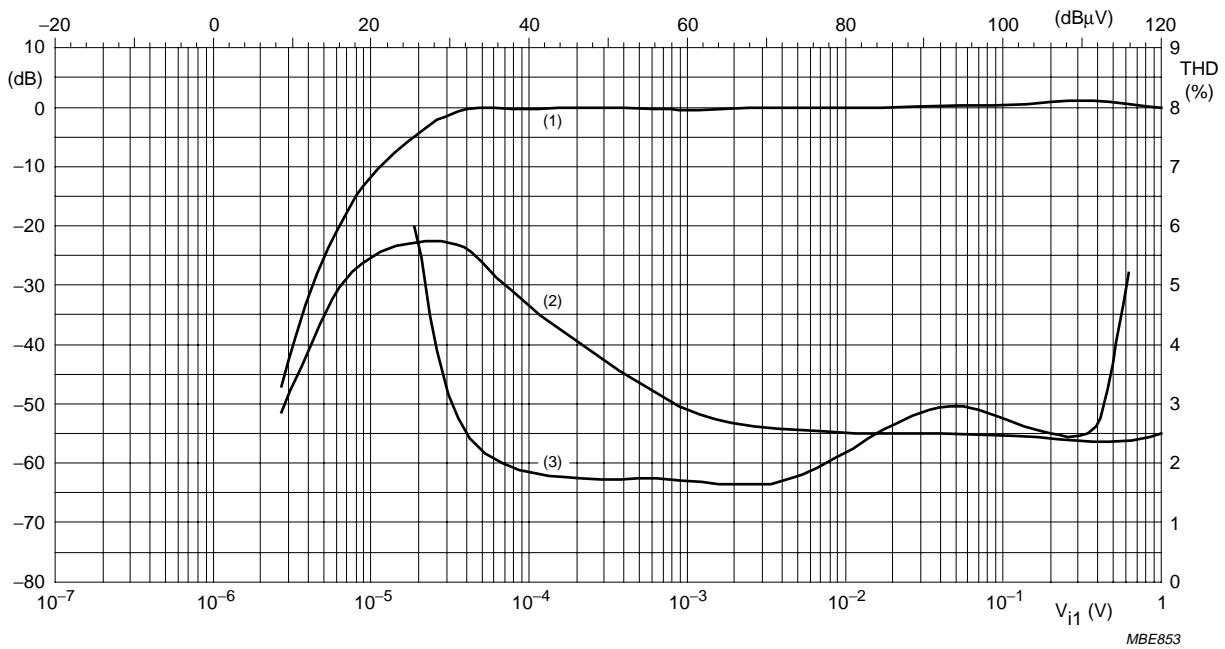

- (1) Audio signal.
- (2) Noise.
- (3) Harmonic distortion.

Fig.6 AM mode.

Self Tuned Radio (STR)

TEA5757; TEA5759

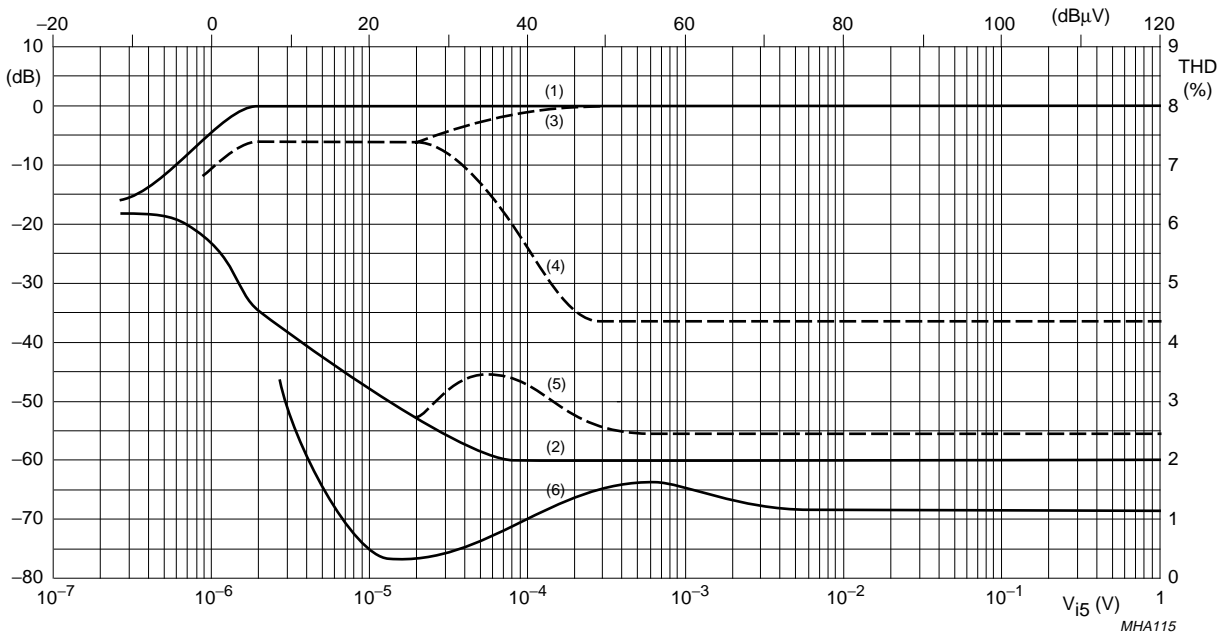

- (1) Mono signal.
- (2) Noise in mono mode.
- (3) Left channel with modulation left.
- (4) Right channel with modulation left.
- (5) Noise in stereo mode.
- (6) Harmonic distortion (measured with $\Delta f = 75$ kHz).

Fig.7 FM mode.

Self Tuned Radio (STR)

TEA5757; TEA5759

INTERNAL CIRCUITRY

Table 8 Equivalent pin circuits and pin voltages

PIN NO.	PIN SYMBOL	DC VOLTAGE (V)		EQUIVALENT CIRCUIT
		AM	FM	
1	RIPPLE	2.1	2.1	<p>MBE821</p>
2	AM-RFI	0	0	<p>MBE822</p>
3	FM-RFO	0	0	<p>MHA105</p>
4	RFGND	0	0	
5	FMOSC	0	0	<p>MBE823</p>

Self Tuned Radio (STR)

TEA5757; TEA5759

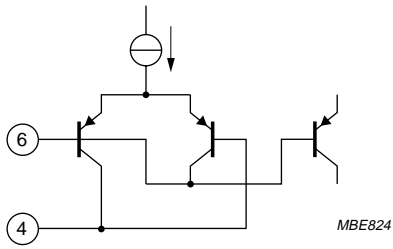
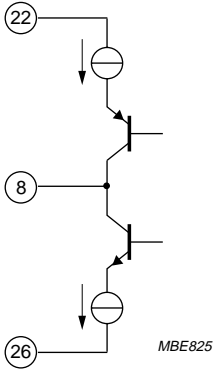
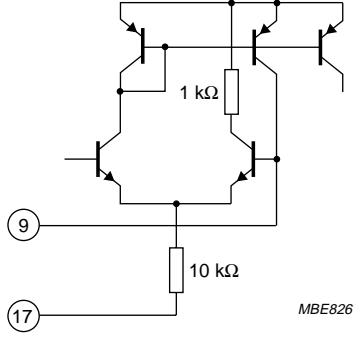
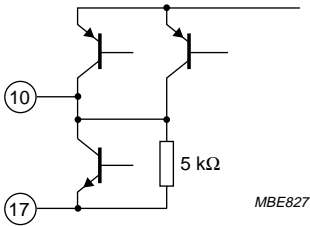
PIN NO.	PIN SYMBOL	DC VOLTAGE (V)		EQUIVALENT CIRCUIT
		AM	FM	
6	AMOSC	0	0	 <p>MBE824</p>
7	V _{CC1}	3.0	3.0	
8	TUNE	-	-	 <p>MBE825</p>
9	VCO	1.3	0.95	 <p>MBE826</p>
10	AFO	0.6	0.7	 <p>MBE827</p>

Self Tuned Radio (STR)

TEA5757; TEA5759

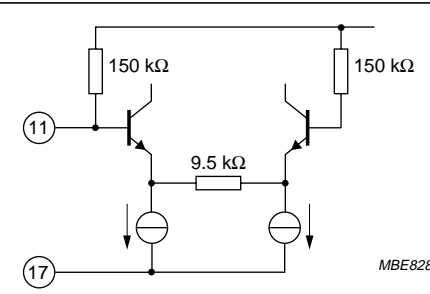
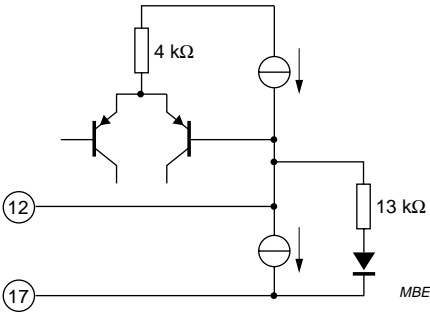
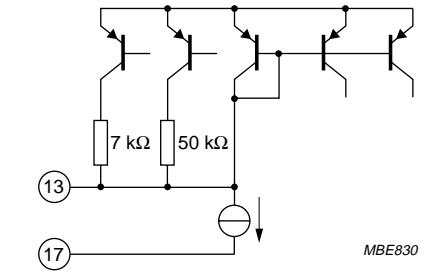
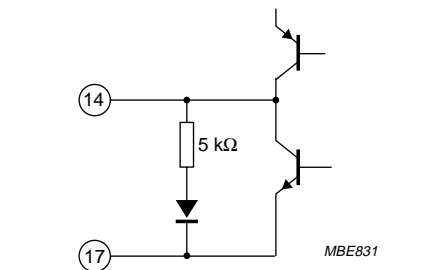
PIN NO.	PIN SYMBOL	DC VOLTAGE (V)		EQUIVALENT CIRCUIT
		AM	FM	
11	MPXI	1.23	1.23	 <p style="text-align: right;"><i>MBE828</i></p>
12	LFI	0.1	0.8	 <p style="text-align: right;"><i>MBE829</i></p>
13	MUTE	0.7	0.7	 <p style="text-align: right;"><i>MBE830</i></p>
14	AFLO	0.65	0.65	 <p style="text-align: right;"><i>MBE831</i></p>

Self Tuned Radio (STR)

TEA5757; TEA5759

PIN NO.	PIN SYMBOL	DC VOLTAGE (V)		EQUIVALENT CIRCUIT
		AM	FM	
15	AFRO	0.65	0.65	<p>The diagram shows a transistor circuit with a 5 kΩ resistor and a diode connected to pin 15. The diode is oriented towards pin 17. The circuit is labeled MBE832.</p>
16	PILFIL	0.95	0.95	<p>The diagram shows a complex transistor circuit with two 10 kΩ resistors and several current sources. Pin 16 is connected to the top of the circuit, and pin 17 is connected to the bottom. The circuit is labeled MBE833.</p>
17	IFGND	0	0	
18	FMDEM	-	1.0	<p>The diagram shows a transistor circuit with a 180 Ω resistor connected to pin 18 and a 910 Ω resistor connected to pin 17. The circuit is labeled MBE834.</p>
19	AFC _(n)	-	-	<p>The diagram shows a transistor circuit with two 10 kΩ resistors and a current source. Pin 19 is connected to the node between the two resistors. The circuit is labeled MHA106.</p>

Self Tuned Radio (STR)

TEA5757; TEA5759

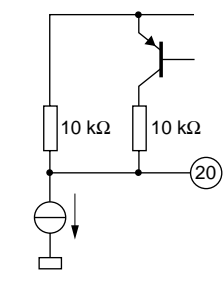
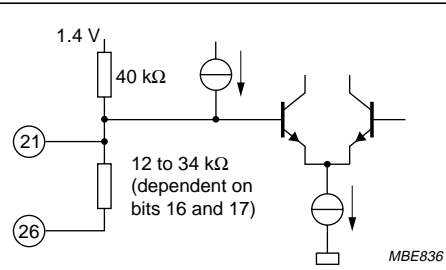
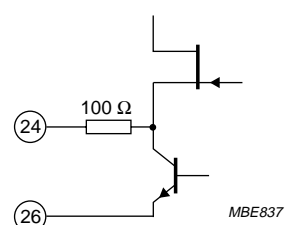
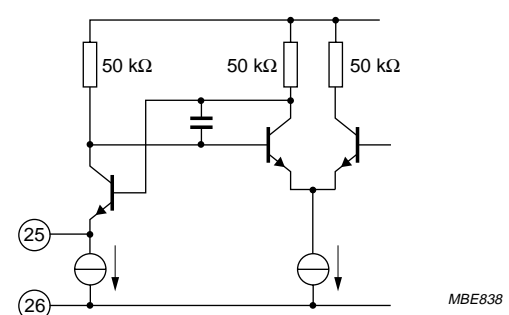
PIN NO.	PIN SYMBOL	DC VOLTAGE (V)		EQUIVALENT CIRCUIT
		AM	FM	
20	AFC _(p)	-	-	 <p>MHA107</p>
21	FSI	-	-	 <p>MBE836</p>
22	V _{CC2}	-	-	
23	V _{DDD}	3.0	3.0	
24	MO/ST	-	-	 <p>MBE837</p>
25	XTAL	-	-	 <p>MBE838</p>
26	DGND	0	0	

Self Tuned Radio (STR)

TEA5757; TEA5759

PIN NO.	PIN SYMBOL	DC VOLTAGE (V)		EQUIVALENT CIRCUIT
		AM	FM	
27	BUS-CLOCK	-	-	
28	DATA	-	-	
29	WRITE-ENABLE	-	-	
30	P0	-	-	
31	P1	-	-	

Self Tuned Radio (STR)

TEA5757; TEA5759

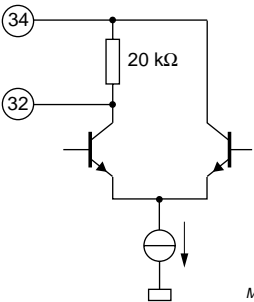
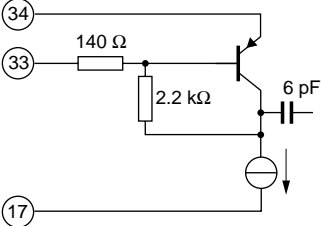
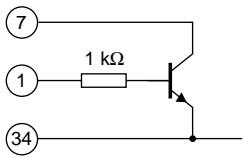
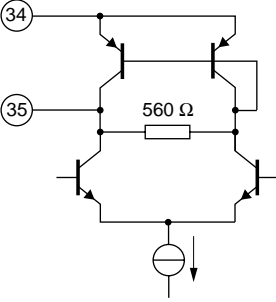
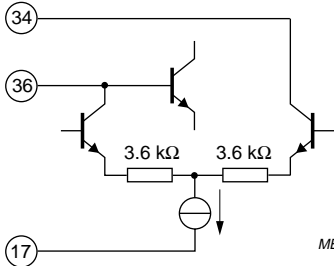
PIN NO.	PIN SYMBOL	DC VOLTAGE (V)		EQUIVALENT CIRCUIT
		AM	FM	
32	AFC	-	-	 <p>MBE842</p>
33	FM-IFI2	-	0.73	 <p>MBE843</p>
34	V _{STAB(B)}	1.4	1.4	 <p>MBE844</p>
35	FM-IFO1	-	0.69	 <p>MBE845</p>
36	AM-IFI/O2	1.4	1.4	 <p>MBE846</p>

Self Tuned Radio (STR)

TEA5757; TEA5759

PIN NO.	PIN SYMBOL	DC VOLTAGE (V)		EQUIVALENT CIRCUIT
		AM	FM	
37	FM-IF11	-	0.73	
38	V _{STAB(A)}	1.4	1.4	
39	FM-MIXER	-	1.0	
40	AM-MIXER	1.4	1.4	
41	AM-IF11	1.4	1.4	

Self Tuned Radio (STR)

TEA5757; TEA5759

PIN NO.	PIN SYMBOL	DC VOLTAGE (V)		EQUIVALENT CIRCUIT
		AM	FM	
42	RFGND	0	0	
43	FM-RFI	-	0.73	
44	AGC	0.1	0.7	

Self Tuned Radio (STR)

TEA5757; TEA5759

TEST AND APPLICATION INFORMATION

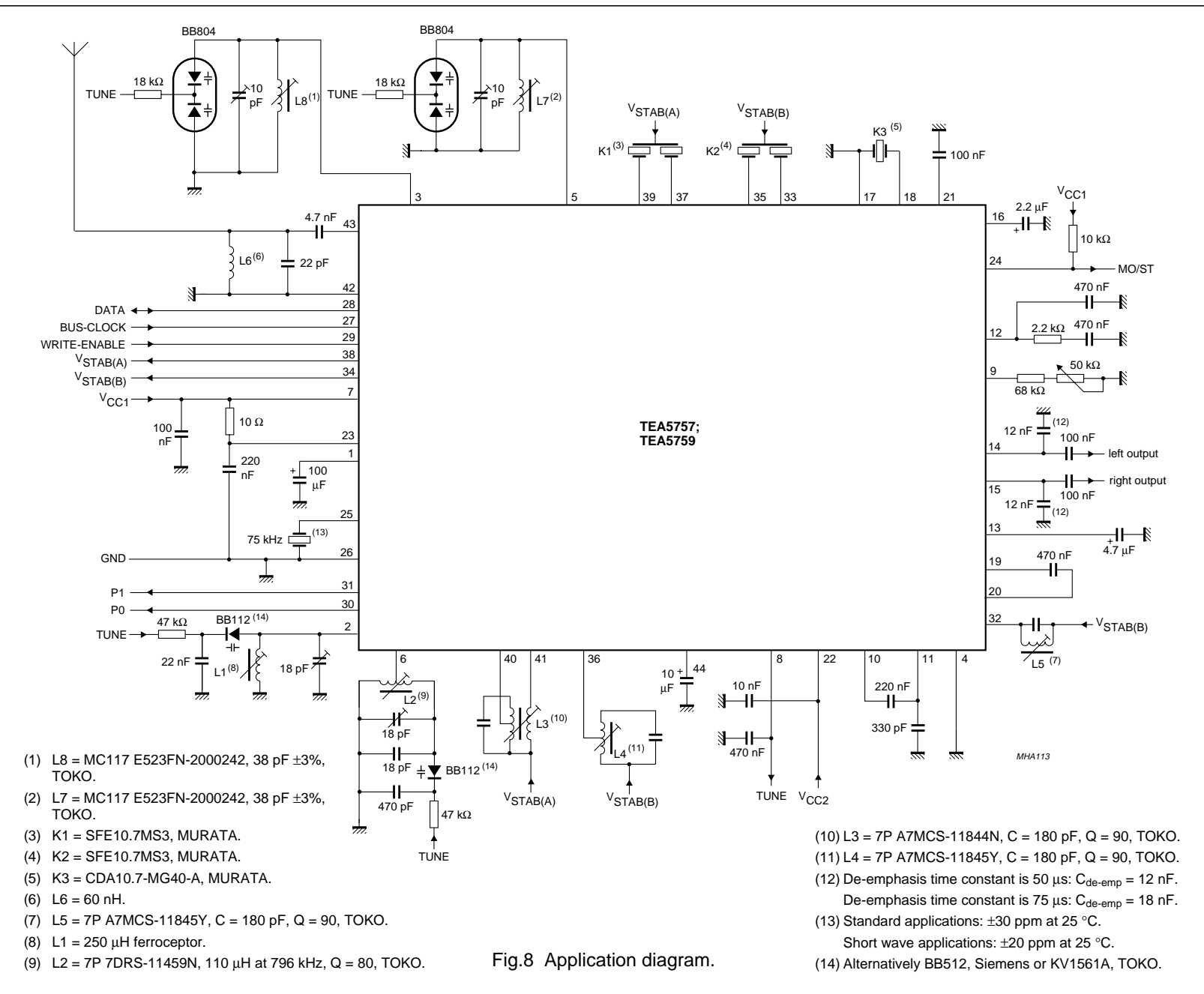

- (1) L8 = MC117 E523FN-2000242, 38 pF ±3%, TOKO.
- (2) L7 = MC117 E523FN-2000242, 38 pF ±3%, TOKO.
- (3) K1 = SFE10.7MS3, MURATA.
- (4) K2 = SFE10.7MS3, MURATA.
- (5) K3 = CDA10.7-MG40-A, MURATA.
- (6) L6 = 60 nH.
- (7) L5 = 7P A7MCS-11845Y, C = 180 pF, Q = 90, TOKO.
- (8) L1 = 250 μH ferroceptor.
- (9) L2 = 7P 7DRS-11459N, 110 μH at 796 kHz, Q = 80, TOKO.

- (10) L3 = 7P A7MCS-11844N, C = 180 pF, Q = 90, TOKO.
- (11) L4 = 7P A7MCS-11845Y, C = 180 pF, Q = 90, TOKO.
- (12) De-emphasis time constant is 50 μs: C_{de-emp} = 12 nF.
De-emphasis time constant is 75 μs: C_{de-emp} = 18 nF.
- (13) Standard applications: ±30 ppm at 25 °C.
Short wave applications: ±20 ppm at 25 °C.
- (14) Alternatively BB512, Siemens or KV1561A, TOKO.

Fig.8 Application diagram.

Self Tuned Radio (STR)

TEA5757; TEA5759

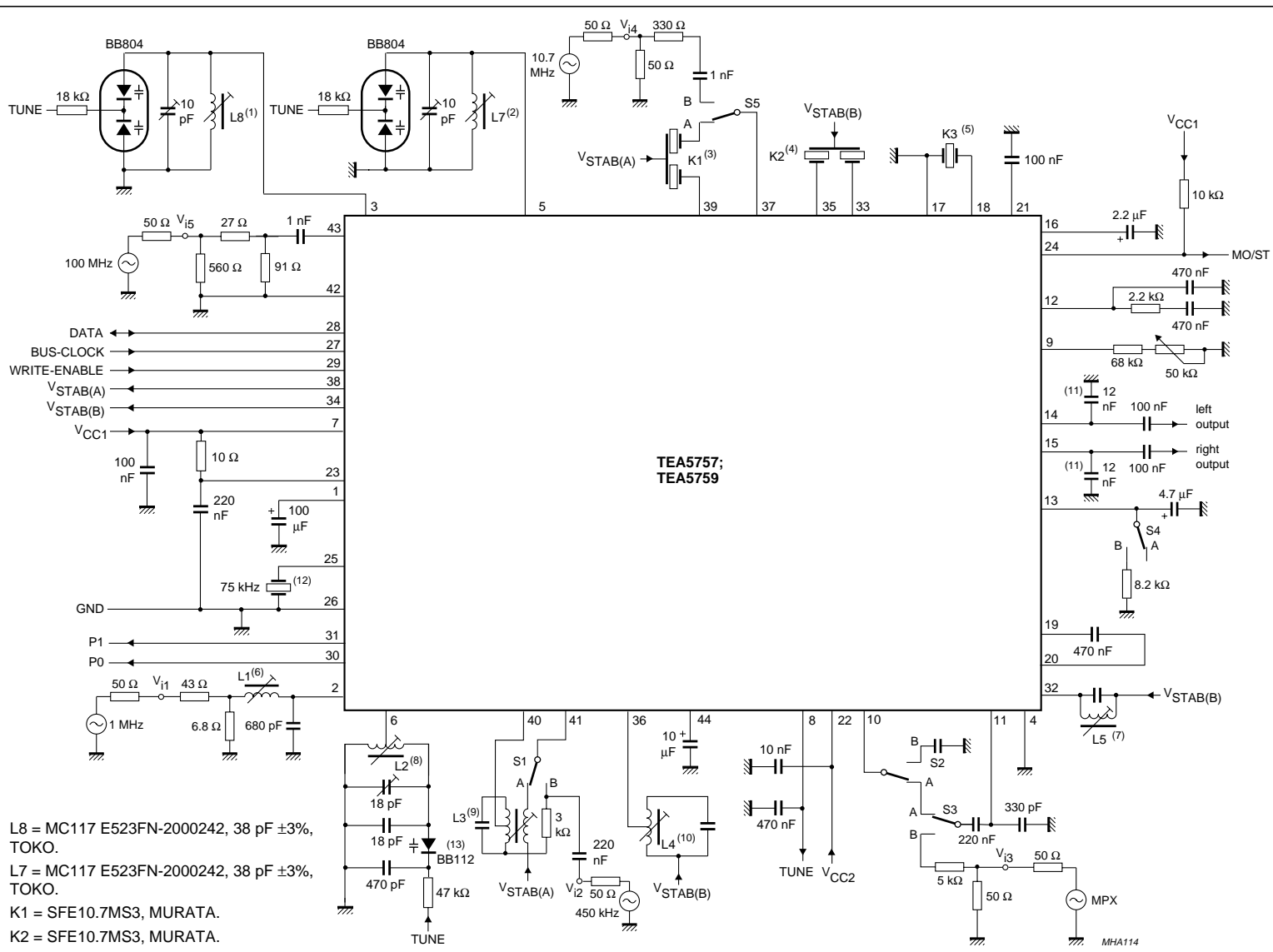

- (1) L8 = MC117 E523FN-2000242, 38 pF ±3%, TOKO.
- (2) L7 = MC117 E523FN-2000242, 38 pF ±3%, TOKO.
- (3) K1 = SFE10.7MS3, MURATA.
- (4) K2 = SFE10.7MS3, MURATA.
- (5) K3 = CDA10.7-MG40-A, MURATA.
- (6) L1 = 22281-30091.
- (7) L5 = 7P A7MCS-11845Y, C = 180 pF, Q = 90, TOKO.
- (8) L2 = 7P 7DRS-11459N, 110 µH at 796 kHz, Q = 80, TOKO.
- (9) L3 = 7P A7MCS-11844N, C = 180 pF, Q = 90, TOKO.
- (10) L4 = 7P A7MCS-11845Y, C = 180 pF, Q = 90, TOKO.

- (11) De-emphasis time constant is 50 µs: C_{de-emp} = 12 nF.
De-emphasis time constant is 75 µs: C_{de-emp} = 18 nF.
- (12) Standard applications: ±30 ppm at 25 °C.
Short wave applications: ±20 ppm at 25 °C.
- (13) Alternatively BB512, Siemens or KV1561A, TOKO.

Fig.9 Test circuit.

Self Tuned Radio (STR)

TEA5757; TEA5759

PACKAGE OUTLINE

QFP44: plastic quad flat package; 44 leads (lead length 1.3 mm); body 10 x 10 x 1.75 mm

SOT307-2

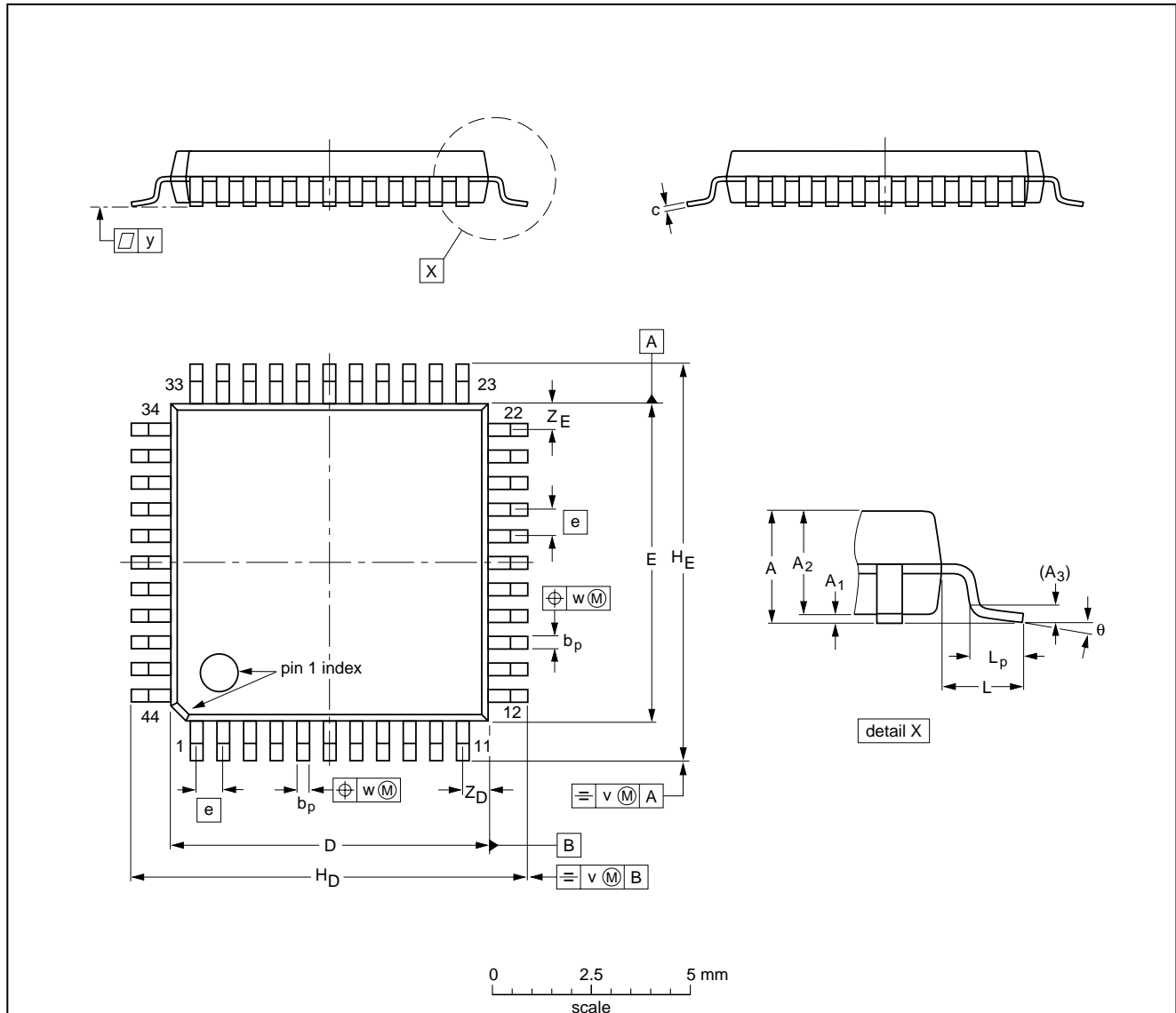

DIMENSIONS (mm are the original dimensions)

UNIT	A max.	A ₁	A ₂	A ₃	b _p	c	D ⁽¹⁾	E ⁽¹⁾	e	H _D	H _E	L	L _p	v	w	y	Z _D ⁽¹⁾	Z _E ⁽¹⁾	θ
mm	2.10	0.25 0.05	1.85 1.65	0.25	0.40 0.20	0.25 0.14	10.1 9.9	10.1 9.9	0.8	12.9 12.3	12.9 12.3	1.3	0.95 0.55	0.15	0.15	0.1	1.2 0.8	1.2 0.8	10° 0°

Note

1. Plastic or metal protrusions of 0.25 mm maximum per side are not included.

OUTLINE VERSION	REFERENCES				EUROPEAN PROJECTION	ISSUE DATE
	IEC	JEDEC	EIAJ			
SOT307-2						95-02-04 97-08-01

Self Tuned Radio (STR)

TEA5757; TEA5759

SOLDERING

Introduction to soldering surface mount packages

This text gives a very brief insight to a complex technology. A more in-depth account of soldering ICs can be found in our *"Data Handbook IC26; Integrated Circuit Packages"* (document order number 9398 652 90011).

There is no soldering method that is ideal for all surface mount IC packages. Wave soldering is not always suitable for surface mount ICs, or for printed-circuit boards with high population densities. In these situations reflow soldering is often used.

Reflow soldering

Reflow soldering requires solder paste (a suspension of fine solder particles, flux and binding agent) to be applied to the printed-circuit board by screen printing, stencilling or pressure-syringe dispensing before package placement.

Several methods exist for reflowing; for example, infrared/convection heating in a conveyor type oven. Throughput times (preheating, soldering and cooling) vary between 100 and 200 seconds depending on heating method.

Typical reflow peak temperatures range from 215 to 250 °C. The top-surface temperature of the packages should preferably be kept below 230 °C.

Wave soldering

Conventional single wave soldering is not recommended for surface mount devices (SMDs) or printed-circuit boards with a high component density, as solder bridging and non-wetting can present major problems.

To overcome these problems the double-wave soldering method was specifically developed.

If wave soldering is used the following conditions must be observed for optimal results:

- Use a double-wave soldering method comprising a turbulent wave with high upward pressure followed by a smooth laminar wave.
- For packages with leads on two sides and a pitch (e):
 - larger than or equal to 1.27 mm, the footprint longitudinal axis is **preferred** to be parallel to the transport direction of the printed-circuit board;
 - smaller than 1.27 mm, the footprint longitudinal axis **must** be parallel to the transport direction of the printed-circuit board.

The footprint must incorporate solder thieves at the downstream end.

- For packages with leads on four sides, the footprint must be placed at a 45° angle to the transport direction of the printed-circuit board. The footprint must incorporate solder thieves downstream and at the side corners.

During placement and before soldering, the package must be fixed with a droplet of adhesive. The adhesive can be applied by screen printing, pin transfer or syringe dispensing. The package can be soldered after the adhesive is cured.

Typical dwell time is 4 seconds at 250 °C.

A mildly-activated flux will eliminate the need for removal of corrosive residues in most applications.

Manual soldering

Fix the component by first soldering two diagonally-opposite end leads. Use a low voltage (24 V or less) soldering iron applied to the flat part of the lead. Contact time must be limited to 10 seconds at up to 300 °C.

When using a dedicated tool, all other leads can be soldered in one operation within 2 to 5 seconds between 270 and 320 °C.

Self Tuned Radio (STR)

TEA5757; TEA5759

Suitability of surface mount IC packages for wave and reflow soldering methods

PACKAGE	SOLDERING METHOD	
	WAVE	REFLOW ⁽¹⁾
BGA, SQFP	not suitable	suitable
HLQFP, HSQFP, HSOP, HTSSOP, SMS	not suitable ⁽²⁾	suitable
PLCC ⁽³⁾ , SO, SOJ	suitable	suitable
LQFP, QFP, TQFP	not recommended ⁽³⁾⁽⁴⁾	suitable
SSOP, TSSOP, VSO	not recommended ⁽⁵⁾	suitable

Notes

- All surface mount (SMD) packages are moisture sensitive. Depending upon the moisture content, the maximum temperature (with respect to time) and body size of the package, there is a risk that internal or external package cracks may occur due to vaporization of the moisture in them (the so called popcorn effect). For details, refer to the Drypack information in the "Data Handbook IC26; Integrated Circuit Packages; Section: Packing Methods".
- These packages are not suitable for wave soldering as a solder joint between the printed-circuit board and heatsink (at bottom version) can not be achieved, and as solder may stick to the heatsink (on top version).
- If wave soldering is considered, then the package must be placed at a 45° angle to the solder wave direction. The package footprint must incorporate solder thieves downstream and at the side corners.
- Wave soldering is only suitable for LQFP, TQFP and QFP packages with a pitch (e) equal to or larger than 0.8 mm; it is definitely not suitable for packages with a pitch (e) equal to or smaller than 0.65 mm.
- Wave soldering is only suitable for SSOP and TSSOP packages with a pitch (e) equal to or larger than 0.65 mm; it is definitely not suitable for packages with a pitch (e) equal to or smaller than 0.5 mm.

DEFINITIONS

Data sheet status	
Objective specification	This data sheet contains target or goal specifications for product development.
Preliminary specification	This data sheet contains preliminary data; supplementary data may be published later.
Product specification	This data sheet contains final product specifications.
Limiting values	
Limiting values given are in accordance with the Absolute Maximum Rating System (IEC 134). Stress above one or more of the limiting values may cause permanent damage to the device. These are stress ratings only and operation of the device at these or at any other conditions above those given in the Characteristics sections of the specification is not implied. Exposure to limiting values for extended periods may affect device reliability.	
Application information	
Where application information is given, it is advisory and does not form part of the specification.	

LIFE SUPPORT APPLICATIONS

These products are not designed for use in life support appliances, devices, or systems where malfunction of these products can reasonably be expected to result in personal injury. Philips customers using or selling these products for use in such applications do so at their own risk and agree to fully indemnify Philips for any damages resulting from such improper use or sale.

Philips Semiconductors – a worldwide company

Argentina: see South America

Australia: 3 Figtree Drive, HOME BUSH, NSW 2140,
Tel. +61 2 9704 8141, Fax. +61 2 9704 8139

Austria: Computerstr. 6, A-1101 WIEN, P.O. Box 213,
Tel. +43 1 60 101 1248, Fax. +43 1 60 101 1210

Belarus: Hotel Minsk Business Center, Bld. 3, r. 1211, Volodarski Str. 6,
220050 MINSK, Tel. +375 172 20 0733, Fax. +375 172 20 0773

Belgium: see The Netherlands

Brazil: see South America

Bulgaria: Philips Bulgaria Ltd., Energoproject, 15th floor,
51 James Bourchier Blvd., 1407 SOFIA,
Tel. +359 2 68 9211, Fax. +359 2 68 9102

Canada: PHILIPS SEMICONDUCTORS/COMPONENTS,
Tel. +1 800 234 7381, Fax. +1 800 943 0087

China/Hong Kong: 501 Hong Kong Industrial Technology Centre,
72 Tat Chee Avenue, Kowloon Tong, HONG KONG,
Tel. +852 2319 7888, Fax. +852 2319 7700

Colombia: see South America

Czech Republic: see Austria

Denmark: Sydhavnsgade 23, 1780 COPENHAGEN V,
Tel. +45 33 29 3333, Fax. +45 33 29 3905

Finland: Sinikalliontie 3, FIN-02630 ESPOO,
Tel. +358 9 615 800, Fax. +358 9 6158 0920

France: 51 Rue Carnot, BP317, 92156 SURESNES Cedex,
Tel. +33 1 4099 6161, Fax. +33 1 4099 6427

Germany: Hammerbrookstraße 69, D-20097 HAMBURG,
Tel. +49 40 2353 60, Fax. +49 40 2353 6300

Hungary: see Austria

India: Philips INDIA Ltd, Band Box Building, 2nd floor,
254-D, Dr. Annie Besant Road, Worli, MUMBAI 400 025,
Tel. +91 22 493 8541, Fax. +91 22 493 0966

Indonesia: PT Philips Development Corporation, Semiconductors Division,
Gedung Philips, Jl. Buncit Raya Kav.99-100, JAKARTA 12510,
Tel. +62 21 794 0040 ext. 2501, Fax. +62 21 794 0080

Ireland: Newstead, Clonskeagh, DUBLIN 14,
Tel. +353 1 7640 000, Fax. +353 1 7640 200

Israel: RAPAC Electronics, 7 Kehilat Saloniki St, PO Box 18053,
TEL AVIV 61180, Tel. +972 3 645 0444, Fax. +972 3 649 1007

Italy: PHILIPS SEMICONDUCTORS, Via Casati, 23 - 20052 MONZA (MI),
Tel. +39 039 203 6838, Fax +39 039 203 6800

Japan: Philips Bldg 13-37, Kohnan 2-chome, Minato-ku,
TOKYO 108-8507, Tel. +81 3 3740 5130, Fax. +81 3 3740 5057

Korea: Philips House, 260-199 Itaewon-dong, Yongsan-ku, SEOUL,
Tel. +82 2 709 1412, Fax. +82 2 709 1415

Malaysia: No. 76 Jalan Universiti, 46200 PETALING JAYA, SELANGOR,
Tel. +60 3 750 5214, Fax. +60 3 757 4880

Mexico: 5900 Gateway East, Suite 200, EL PASO, TEXAS 79905,
Tel. +9-5 800 234 7381, Fax +9-5 800 943 0087

Middle East: see Italy

Netherlands: Postbus 90050, 5600 PB EINDHOVEN, Bldg. VB,
Tel. +31 40 27 82785, Fax. +31 40 27 88399

New Zealand: 2 Wagener Place, C.P.O. Box 1041, AUCKLAND,
Tel. +64 9 849 4160, Fax. +64 9 849 7811

Norway: Box 1, Manglerud 0612, OSLO,
Tel. +47 22 74 8000, Fax. +47 22 74 8341

Pakistan: see Singapore

Philippines: Philips Semiconductors Philippines Inc.,
106 Valero St. Salcedo Village, P.O. Box 2108 MCC, MAKATI,
Metro MANILA, Tel. +63 2 816 6380, Fax. +63 2 817 3474

Poland: Ul. Lukiska 10, PL 04-123 WARSZAWA,
Tel. +48 22 612 2831, Fax. +48 22 612 2327

Portugal: see Spain

Romania: see Italy

Russia: Philips Russia, Ul. Usatcheva 35A, 119048 MOSCOW,
Tel. +7 095 755 6918, Fax. +7 095 755 6919

Singapore: Lorong 1, Toa Payoh, SINGAPORE 319762,
Tel. +65 350 2538, Fax. +65 251 6500

Slovakia: see Austria

Slovenia: see Italy

South Africa: S.A. PHILIPS Pty Ltd., 195-215 Main Road Martindale,
2092 JOHANNESBURG, P.O. Box 58088 Newville 2114,
Tel. +27 11 471 5401, Fax. +27 11 471 5398

South America: Al. Vicente Pinzon, 173, 6th floor,
04547-130 SÃO PAULO, SP, Brazil,
Tel. +55 11 821 2333, Fax. +55 11 821 2382

Spain: Balmes 22, 08007 BARCELONA,
Tel. +34 93 301 6312, Fax. +34 93 301 4107

Sweden: Kottbygatan 7, Akalla, S-16485 STOCKHOLM,
Tel. +46 8 5985 2000, Fax. +46 8 5985 2745

Switzerland: Allmendstrasse 140, CH-8027 ZÜRICH,
Tel. +41 1 488 2741 Fax. +41 1 488 3263

Taiwan: Philips Semiconductors, 6F, No. 96, Chien Kuo N. Rd., Sec. 1,
TAIPEI, Taiwan Tel. +886 2 2134 2886, Fax. +886 2 2134 2874

Thailand: PHILIPS ELECTRONICS (THAILAND) Ltd.,
209/2 Sanpavuth-Bangna Road Prakanong, BANGKOK 10260,
Tel. +66 2 745 4090, Fax. +66 2 398 0793

Turkey: Yukari Dudullu, Org. San. Blg., 2.Cad. Nr. 28 81260 Umraniye,
ISTANBUL, Tel. +90 216 522 1500, Fax. +90 216 522 1813

Ukraine: PHILIPS UKRAINE, 4 Patrice Lumumba str., Building B, Floor 7,
252042 KIEV, Tel. +380 44 264 2776, Fax. +380 44 268 0461

United Kingdom: Philips Semiconductors Ltd., 276 Bath Road, Hayes,
MIDDLESEX UB3 5BX, Tel. +44 208 730 5000, Fax. +44 208 754 8421

United States: 811 East Arques Avenue, SUNNYVALE, CA 94088-3409,
Tel. +1 800 234 7381, Fax. +1 800 943 0087

Uruguay: see South America

Vietnam: see Singapore

Yugoslavia: PHILIPS, Trg N. Pasica 5/v, 11000 BEOGRAD,
Tel. +381 11 62 5344, Fax.+381 11 63 5777

For all other countries apply to: Philips Semiconductors,
International Marketing & Sales Communications, Building BE-p, P.O. Box 218,
5600 MD EINDHOVEN, The Netherlands, Fax. +31 40 27 24825

Internet: <http://www.semiconductors.philips.com>

© Philips Electronics N.V. 1999

SCA 67

All rights are reserved. Reproduction in whole or in part is prohibited without the prior written consent of the copyright owner.

The information presented in this document does not form part of any quotation or contract, is believed to be accurate and reliable and may be changed without notice. No liability will be accepted by the publisher for any consequence of its use. Publication thereof does not convey nor imply any license under patent- or other industrial or intellectual property rights.

Printed in The Netherlands

545002/03/pp32

Date of release: 1999 Aug 26

Document order number: 9397 750 06058

Let's make things better.

Philips
Semiconductors



PHILIPS