

SPB-2840LG / SPB-2840BLG

(RoHS Compliant)

1270 nm TX / 1330 nm RX , 10.3 Gbps 1-Fiber SM LC SFP+ Transceiver

FEATURES

- | 1-Fiber Bi-Directional SFP Optical Transceiver
- | Up to 10.3 Gbps Bi-directional Data Links
- | Compliant with SFP+ MSA
- | Compliant to IEEE 802.3ae 10GBASE-BX
- | Simplex LC Connector
- | 1270 nm DFB LD Transmitter
- | 1330 nm Receiver
- | **Distance Up to 40 km**
- | AC/AC Coupling according to MSA
- | Single +3.3 V Power Supply
- | RoHS Compliant
- | 0 to 70°C Operating: SPB-2840LG
- | -10 to 85°C Operating: SPB-2840BLG
- | Class 1 Laser International Safety Standard IEC 60825 Compliant

DESCRIPTION

The SPB-2840LG series single mode transceiver is small form factor pluggable module for bi-directional serial optical data communications such as IEEE 802.3ae 10GBASE-BX by using 1270 nm transmitter and 1330 nm receiver. It is with the SFP 20-pin connector to allow hot plug capability. The transmitter section uses a multiple quantum well 1270 nm DFB laser and is a class 1 laser compliant according to International Safety Standard IEC 60825. The receiver section uses an integrated 1330 nm detector preamplifier (IDP) mounted in an optical header and a limiting post-amplifier IC.

LASER SAFETY

This single mode transceiver is a Class 1 laser product. It complies with IEC 60825 and FDA 21 CFR 1040.10 and 1040.11. The transceiver must be operated within the specified temperature and voltage limits. The optical ports of the module shall be terminated with an optical connector or with a dust plug.

APPLICATIONS

- | 10G Ethernet Links

ORDER INFORMATION

P/No.	Bit Rate (Gb/s)	10GBASE	Distance (km)	TX (nm)	RX (nm)	Package	Temp (°C)	RoHS Compliant
SPB-2840LG	10.3	BX	40	1270 DFB	1330	LC SFP+	0 to 70	Yes
SPB-2840BLG	10.3	BX	40	1270 DFB	1330	LC SFP+	-10 to 85	Yes

Absolute Maximum Ratings

Parameter	Symbol	Min	Max	Units	Notes
Storage Temperature	Tstg	-40	85	°C	
Operating Case Temperature	Topr	0 -10	70 85	°C	SPB-2840LG SPB-2840BLG
Relative Humidity	RH	0	85	%	Non condensing
Power Supply Voltage	Vcc	0	3.6	V	
Input Voltage	---	GND	Vcc	V	
Output Current	Iout	0	30	mA	

Recommended Operating Conditions

Parameter	Symbol	Min	Typ	Max	Units / Notes
Power Supply Voltage	Vcc	3.13	3.3	3.47	V
Power Supply Current	I _{CC(TX+RX)}		200	300	mA
Operating Case Temperature	Topr	0 -10		70 85	°C / SPB-2840LG °C / SPB-2840BLG
Data Rate			10.3125		Gb/s

Transmitter Optical Specifications (0°C < Topr < 70°C, 3.13V < Vcc < 3.47V)						
Parameter	Symbol	Min	Typ	Max	Units	Notes
Average Launch Power	$P_{O, Avg}$	1		5	dBm	1
Output Center Wavelength	λ_c	1260	1270	1280	nm	
Output Spectrum Width	σ_λ			1	nm	-20 dB width
Side Mode Suppression Ratio	SMSR	30			dB	
Relative Intensity Noise	RIN			-128	dB/Hz	
Average Launch Power of OFF Transmitter				-30	dBm	

1. Output power is power coupled into a 9/125 μ m single-mode fiber.

Receiver Optical Specifications (0°C < Topr < 70°C, 3.13V < Vcc < 3.47V)						
Parameter	Symbol	Min	Typ	Max	Units	Notes
Sensitivity at 10.3 Gb/s				-15	dBm	2, Average Power
Receiver Overload	P_{MAX}	0.5	---		dBm	
LOS -- Deasserted	LOS_D	---	---	-18	dBm	Transition: low to high
LOS -- Asserted	LOS_A	-30	---	---	dBm	Transition: high to low
Wavelength of Operation	λ_c	1320		1340	nm	3

2. Measured with average power; BER < 10⁻¹² and PRBS 2³¹-1.

3. At least 30 dB optical isolation for the wavelength 1260 to 1280 nm.

Electrical Characteristics						
Parameter	Symbol	Min	Typ	Max	Units	Notes
High-Speed Signal (CML) Interface Specification						
Input Data Rate			10.3125		Gb/s	
Differential Input Impedance	R_{in}		100		Ω	
Differential Data Input Amplitude		150		1000	mVpp	Internally AC coupled
Output Data Rate			10.3125		Gb/s	
Differential Output Impedance	R_{out}		100		Ω	
Differential Data Output Amplitude		350	600	700	mVpp	Internally AC coupled
Low-Speed Signal (LVTTTL) Interface Specification						
Input High Voltage		2.0		Vcc+0.3	V	
Input Low Voltage		GND		0.8	V	
Output High Voltage		2.4		Vcc	V	
Output Low Voltage		GND		0.5	V	

CONNECTION DIAGRAM

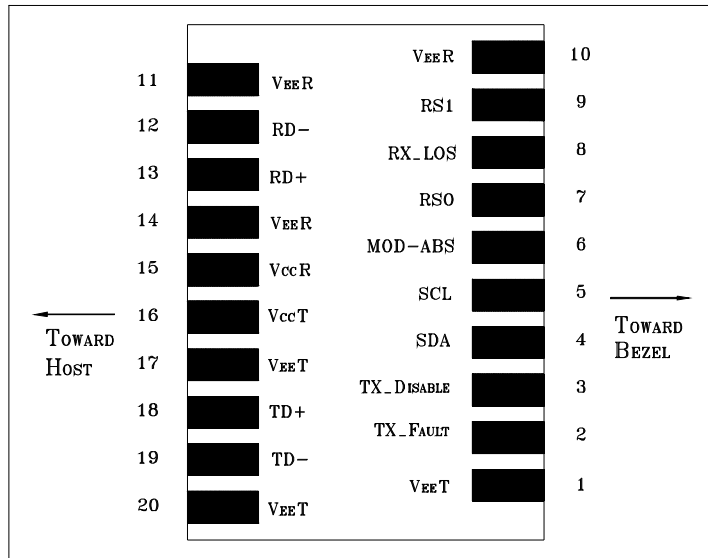

PIN	Signal Name	Description	PIN	Signal Name	Description
1	V _{EE} T	Transmitter Signal Ground	11	V _{EE} R	Receiver Signal Ground
2	TX_Fault	Transmitter Fault Indication. Logic “1” Output = Laser Fault. Logic “0” Output = Normal Operation	12	RD-	Inverse Receiver Data Out
3	TX_Disable	Logic “1” Input (or no connection) = Laser off, Logic “0” = Laser on.	13	RD+	Receiver Data Out
4	SDA	Modulation Definition 2 – Two wires serial ID Interface	14	V _{EE} R	Receiver Signal Ground
5	SDL	Modulation Definition 1 – Two wires serial ID Interface	15	V _{CC} R	Receiver Power – 3.3V±5%
6	MOD-ABS	Modulation Definition 0 – Ground in Module	16	V _{CC} T	Transmitter Power – 3.3V±5%
7	RS0	RX Rate Select (LVTTTL). This pin has an internal 30k pulldown to ground. A signal on this pin will not affect module performance.	17	V _{EE} T	Transmitter Signal Ground
8	RX_LOS	Loss of Signal Out (OC).	18	TD+	Transmitter Data In
9	RS1	TX Rate Select (LVTTTL). This pin has an internal 30k pulldown to ground. A signal on this pin will not affect module performance.	19	TD-	Inverse Transmitter Data In
10	V _{EE} R	Receiver Signal Ground	20	V _{EE} T	Transmitter Signal Ground

MODULE DEFINITION

Module Definition	PIN 4	PIN 5	PIN 6	Interpretation by Host
4	SDA	SCL	MOD-ABS	Serial module definition protocol

Module Definition 4 specifies a serial definition protocol. For this definition, upon power up, SDA and SDL appear as no connector (NC) and MOD-ABS is TTL LOW. When the host system detects this condition, it activates the serial protocol. The protocol uses the 2-wire serial CMOS E²PROM protocol of the ATMEL AT24C01A/02/04 family of components.

RECOMMENDED CIRCUIT SCHEMATIC

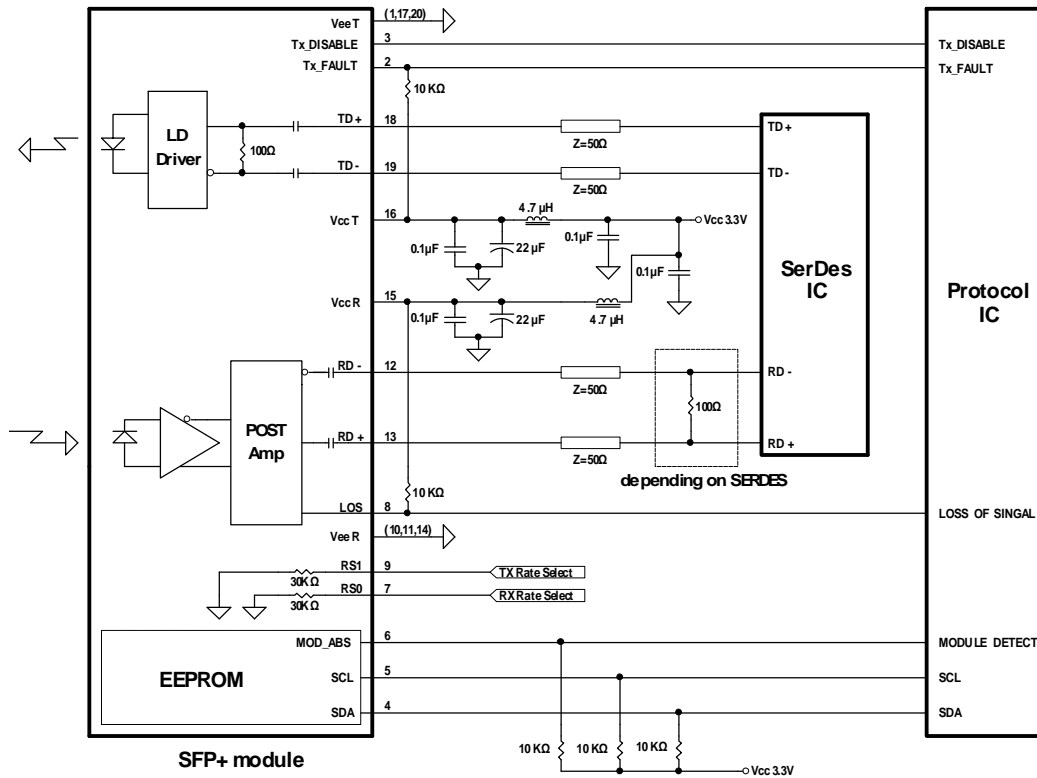

PACKAGE DIAGRAM

Units in mm

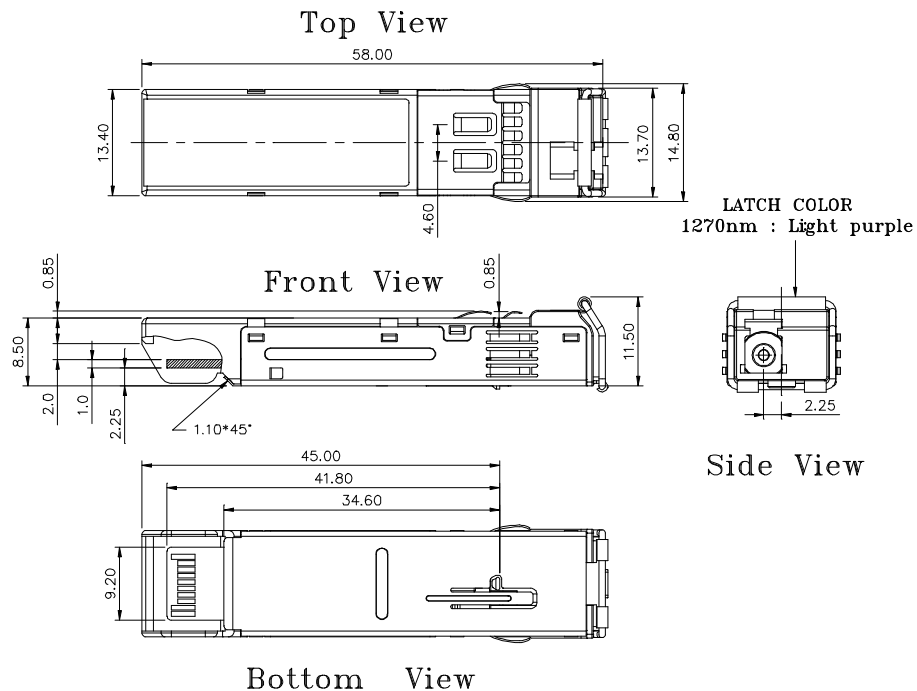

Note: Specifications subject to change without notice.

REVISION HISTORY

Version	Subject	Release Date
1.0	Initial datasheet	2008/10/1