

1. Marking method

Laser Marking.

2. Marking

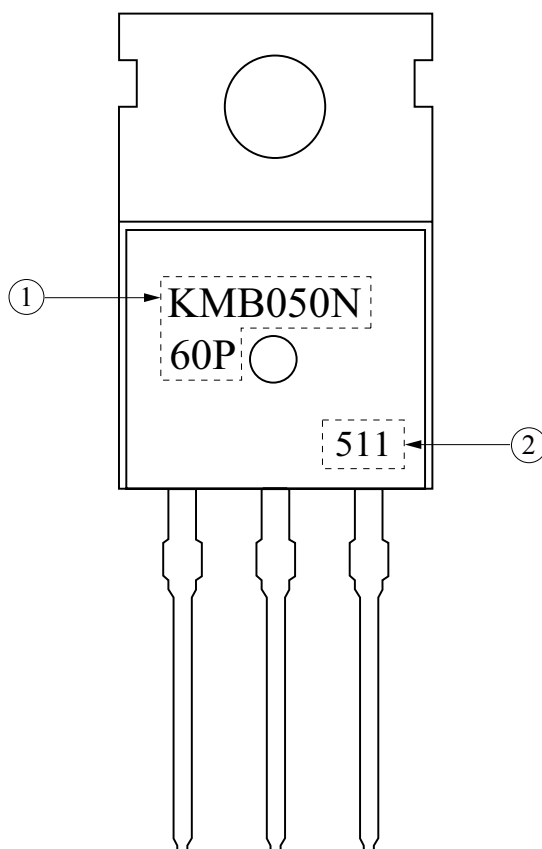

No.	Item	Marking	Description		
①	Device Name	KMB050N60P	KMB050N60P		
②	Lot No.	511	5	Year	0~9 : 2000~2009
			11	Week	11 : 11th Week