

Xinger®

Pico Xinger 10dB Directional Coupler



Description

The 1P510 Pico Xinger is a low profile, miniature 10dB directional coupler in an easy to use surface mount package designed for DCS and PCS applications. The 1P510 is for power and frequency detection as well as power injection. The 1P510 is an ideal solution for the ever-increasing demands of the wireless industry for smaller printed circuit boards and high performance. Parts have been subjected to rigorous qualification testing and units are 100% tested. They are manufactured using materials with x and y thermal expansion coefficients compatible with common substrates. Available in both 5 of 6 tin lead (1P510) and 6 of 6 RoHS compliant tin immersion (1P510S).

Features:

- 1.7 – 2.0 GHz
- DCS and PCS
- Very Low Loss
- High Directivity
- Surface Mountable
- Tape and Reel
- Available in Lead-Free (as illustrated) or Tin-Lead

ELECTRICAL SPECIFICATIONS**

Frequency	Mean Coupling	Insertion Loss	VSWR	Freq. Sensitivity
GHz	dB	dB Max	Max : 1	dB Max
1.7 – 2.0	10 ± 0.75	0.25	1.22	± 0.2
Directivity	Power Handling	⊙JC	Operating Temp.	
dB Min	Ave CW Watts	°C / Watt	°C	
20	20	44	-55 to +85	

**Specification based on performance of unit properly installed on microstrip printed circuit boards with 50 Ω nominal impedance. Specifications subject to change without notice.

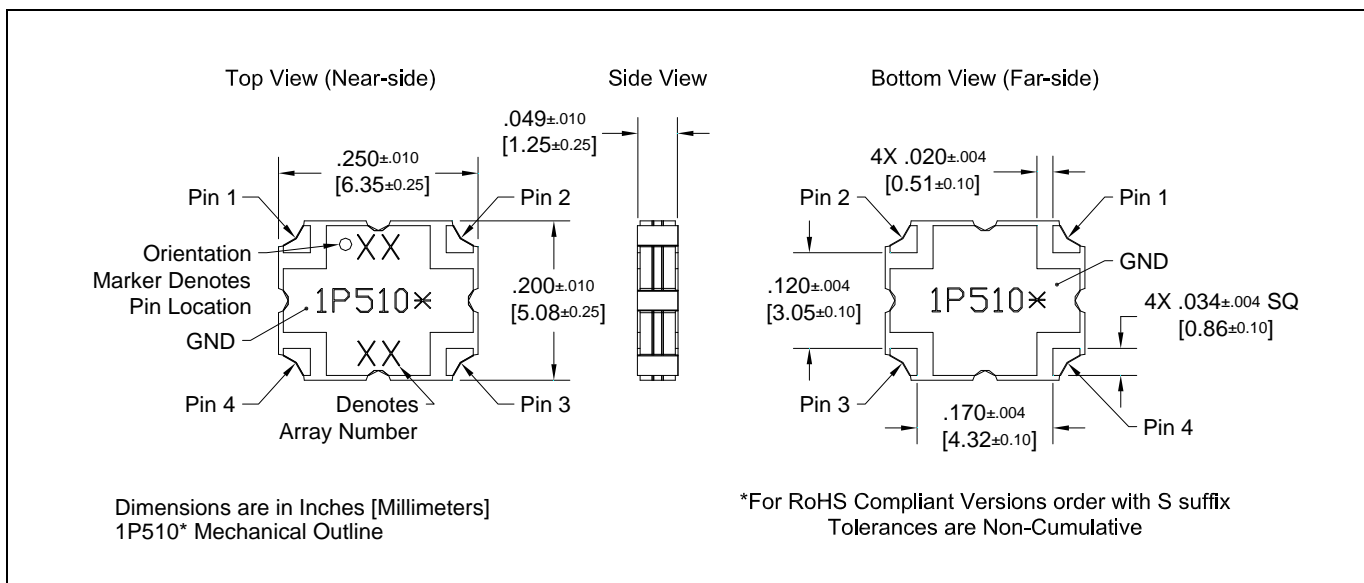

Typical Performance: 1400 MHz – 2300 MHz

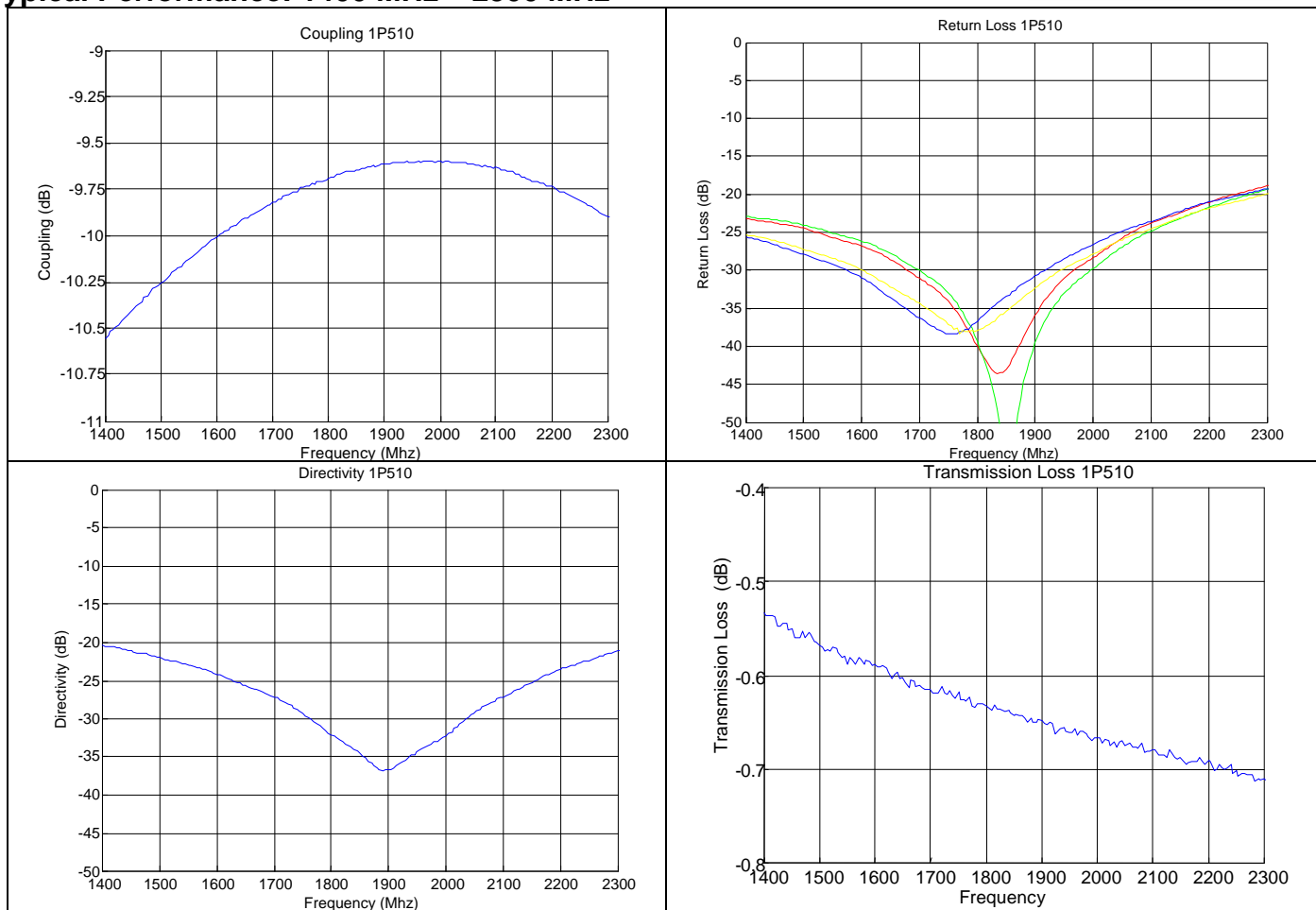

COUPLING

Choice of a coupling value in an application normally depends on the power level of the main (sampled) line. For example, if the coupler is being used to monitor main line power, the coupling value is selected to provide sufficient power to the monitoring device and yet minimize system loss. Note that any coupler reduces power flowing in the main line by the amount coupled off; a 10dB coupler reduces main line power by 1 dB (10%) where a 20dB coupler reduces it by only 0.044dB (1%).

Anaren uses mean coupling and frequency sensitivity with the coupling specification. The mean coupling value is arrived at by periodically sampling the coupling value over the specified band and averaging the readings. Frequency sensitivity is the peak to peak variation in coupling over the specified band.

VSWR & DIRECTIVITY

In directional couplers, directivity is specified in lieu of isolation. Directivity is a measure of how well the coupled power is isolated from reflections at the main line output port. For example, open or short circuiting the output port of a coupler with 20dB directivity would only affect the coupled output power by 1% and only 0.1% for 30dB directivity. High directivity is especially important if the coupler is being used to measure the VSWR of a device at its output port. In this application, accurate measurements of forward and reverse power are required.

In theory, VSWR and directivity characteristics of a coupler are perfect; the input and output ports are perfectly matched and no power is coupled to the isolated port. In practice, factors associated with the design and manufacturing processes limit VSWR and directivity. The





VSWR & DIRECTIVITY (CONTINUED)

internal meandering of the coupled lines and limitations of building perfect 50 Ω transitions at the input and output ports of the device are the most significant factors against perfect VSWR and directivity. Typically, VSWR and directivity of 1.15:1 and 25 dB respectively are achieved in practice.

INSERTION LOSS

Coupler insertion loss is defined as the log of the input power divided by the sum of the power at the two output ports. In practice, typical loss is approximately 0.20 dB. Specification limits are somewhat higher due to imperfect test conditions; surface mount couplers must be tested in test fixtures that negatively affect results.

PIN CONFIGURATION

The 1P510's have an orientation marker to denote either pin 1 or pin 2. When the input port is identified, the output, coupled and isolated ports are known automatically. For example, if the input port for a device was selected to be Pin 1, Pin 4 automatically becomes the output port, Pin 3 becomes the coupled port, and Pin 2 is the isolated port. Similarly, if Pin 2 was to be selected as the input port, the adjacent port on the long side (Pin 1) is the output port, the adjacent port on the short side (Pin 3) is the coupled port, and the opposite port (Pin 4) is the isolated port. Either port on the same side as the orientation marker can be selected as the input port, as shown in the table, which shows both pin configurations. The use of pin 1 or pin 2 as the input port ensures phase consistency as well as maximum power handling.

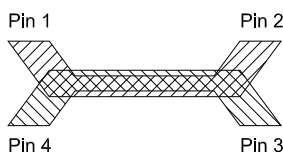

Directional Coupler Pin Configuration				
	Pin 1	Pin 2	Pin 3	Pin 4
Configuration #1	Input	Output	Isolated	Coupled
Configuration #2	Output	Input	Coupled	Isolated

MOUNTING

For Xinger surface mount couplers to operate optimally, there must be 50Ω transmission lines leading to and from all of the RF ports. To ensure proper electrical and thermal performance, there must be a ground plane with 100% solder connection underneath the part. If either of these two conditions is not satisfied, insertion loss, coupling, VSWR and directivity may not meet published specifications.

SUGGESTED FOOTPRINT

To ensure proper electrical and thermal performance there must be a ground plane with 100% solder connection underneath the part

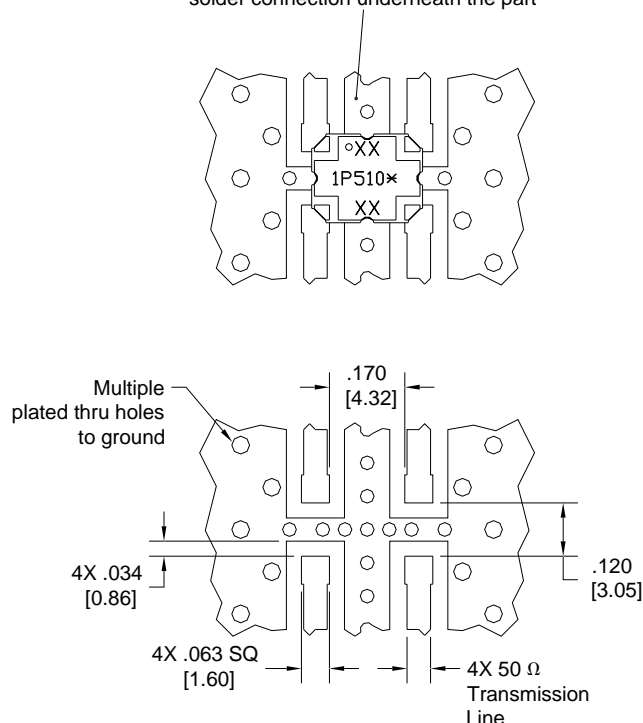

Dimensions are in Inches [Millimeters]
1P510* Mounting Footprint



PACKAGING

Packaging follows EIA 481-2. Parts are oriented in tape as shown below. Minimum order quantities are 2000 per reel and 77 per tube.

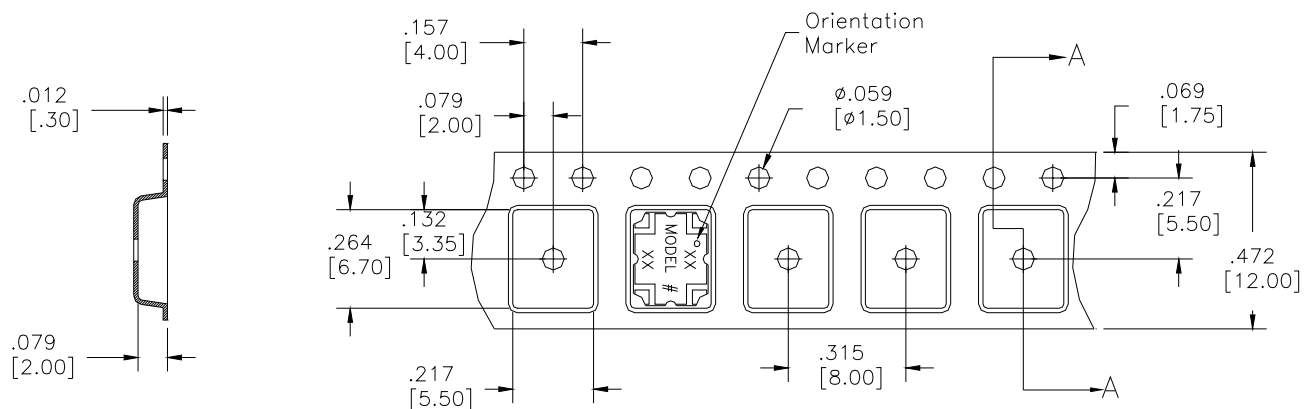

SECTION A-A

Dimensions are in inches [mm]

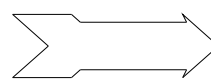

Direction of Part Feed (Unloading)

Xinger® Tape & Reel Diagram

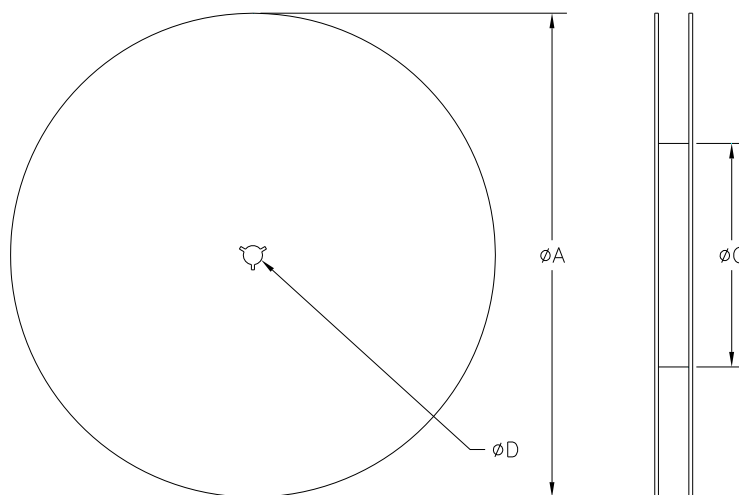

TABLE 1	
REEL DIMENSIONS (inches [mm])	
ϕA	13.3 [333.0]
B	0.472 [12.0]
ϕC	4.017 [102.03]
ϕD	0.512 [13.0]

USA/Canada: (315) 432-8909
Toll Free: (800) 544-2414
Europe: +44 2392-232392

Available on Tape and Reel For Pick and Place Manufacturing.



Anaren

What'll we think of next