

Digital Timer

H5CL

Easy-to-see and Easy-to-operate DIN 48 x 48 mm Digital Timer with IP66/NEMA 4 Protection

- Water- and dust-protected for severe environments.
- Large, high-visibility LED displays with a height of 12 mm.
- Simple setting with Increment and Decrement Keys.
- Conforms to EMC standards.
- Six-language instruction manual provided.



Ordering Information

Outputs	Supply voltage	Model	
		Without Finger Safe Terminal Cover	With Finger Safe Terminal Cover
Contact output	100 to 240 VAC	H5CL-A	---
	12 to 24 VDC	H5CL-AD	H5CL-AD-500
Transistor output (Photocoupler)	100 to 240 VAC	H5CL-AS	---
	12 to 24 VDC	H5CL-ADS	---

Model Number Legend:

H5CL-A
1 2 3

1. Fixed
2. D: DC Supply Voltage
3. S: Transistor output

■ Accessories (Order Separately)

Name	Model
Hard cover	Y92A-48
Soft cover	Y92A-48F1
Track Mounting/Front Connecting Socket (for AC models only)	---
	Finger safe type
Back Connecting Socket (for AC models only)	---
	Finger safe type
Finger Safe Terminal Cover for DC models	Y92A-48T
Flush Mounting Adapter (see note 2)	Y92F-30

- Note:**
1. Y92A-48G is a finger safe terminal cover which is attached to the P3GA-11 Socket.
 2. Supplied with each Unit.

Specifications

Item	H5CL-A□ (AC models)	H5CL-AD□ (DC models)
Classification	Digital timer	
Mounting	DIN track, surface, and flush mounting (common)	Flush mounting
External connections	Socket	Screw terminals
Enclosure ratings	Panel surface: IEC IP66 and NEMA Type 4 (indoors) when Y92S-29 rubber packing is used.	
Digits	4 digits (zero suppress method)	
Max. time settings	9.999 s (0.001-s unit), 99.99 s (0.01-s unit), 999.9 s (0.1-s unit), 9999 s (1-s unit), 99 min 59 s (1-s unit), 999.9 min (0.1-min unit), 99 h 59 min (1-min unit), 999.9 h (0.1-h unit)	
Display modes	Up (increment) and Down (decrement) (selectable)	
Input signals	Start, gate, reset, and key protection	
Input method	No-voltage input: via NPN transistor or switching of contact	
Operating modes	A (signal ON-delay), F (accumulative operation) (selectable)	
Reset system	Power reset (A (signal ON-delay) mode only), external, manual resets	
Sensor waiting time	216 ms typ., 250 ms max. (Control output is turned OFF and no input is accepted during sensor waiting time.)	
External power supply	50 mA at 12 VDC ($\pm 10\%$)	---
Display	7-segment LEDs (12 mm high, red LEDs for the present value, and 8 mm high, green LEDs for the set value)	
Memory backup	EEP-ROM (overwritten 200,000 times min.), which can store data for 20 years min.	
Mounting method	DIN track mounting, surface mounting, and flush mounting	Flush mounting
Approved standards	UL 508, CSA C22.2 No.14 Conforms to EN61010-1	

■ Ratings

Item	H5CL-A□ (AC models)	H5CL-AD□ (DC models)
Rated supply voltage	100 to 240 VAC, 50/60 Hz	12 to 24 VDC (permissible ripple: 20% (p-p) max.)
Operating voltage range	85 to 264 VAC, 50/60 Hz	10.8 to 26.4 VDC
Power consumption	Approx. 10 VA	Approx. 3 W
Start, reset, gate inputs	Min. pulse width: 1 ms/20 ms (selectable, same for all three inputs)	
Key protection input	Response time: 1 s max.	
Power reset	Min. power opening time: 0.5 s (excluding F (accumulative operation) mode)	
Control output	Contact output: SPDT, 3 A at 250 VAC, resistive load ($\cos\phi = 1$) Min. applicable load: 10 mA at 5/24 VDC (P level, for reference value) Transistor output: NPN open collector, 100 mA max. at 30 VDC max., residual voltage 1.5 VDC max.	

■ Characteristics

Item	H5CL-A□ (AC models)	H5CL-AD□ (DC models)
Deviation of operating time and setting error (including temperature and voltage influences)	Power start: $\pm 0.01\% \pm 0.05$ s max. (see note 1) Signal start: $\pm 0.005\% \pm 0.03$ s max. (see note 1) Signal start, at transistor output model: $\pm 0.005\% \pm 3$ ms max. (see note 1 and 2) If the set value is within the sensor waiting time (250 ms max.) in the case of power start, the control output of the H5CL will not be turned ON until the sensor waiting time passes.	
Insulation resistance	100 M Ω min. (at 500 VDC) (between current-carrying terminal and exposed non-current-carrying metal parts, and between non-continuous contacts)	
Dielectric strength	2,000 VAC, 50/60 Hz for 1 min (between current-carrying terminal and exposed non-current-carrying metal parts) 1,000 VAC, 50/60 Hz for 1 min (between non-continuous contacts)	1,000 VAC, 50/60 Hz for 1 min (between current-carrying terminal and exposed non-current-carrying metal parts, and between non-continuous contacts)
Impulse withstand voltage	3.0 kV (between power terminals) 4.5 kV (between current-carrying terminal and exposed non-current-carrying metal parts)	1.0 kV (between power terminals) 1.5 kV (between current-carrying terminal and exposed non-current-carrying metal parts)
Noise immunity	± 1.5 kV (between power terminals) ± 600 V (between input terminals), square-wave noise by noise simulator (pulse width: 100 ns/1 μ s, 1-ns rise)	± 480 kV (between power terminals) ± 600 V (between input terminals), square-wave noise by noise simulator (pulse width: 100 ns/1 μ s, 1-ns rise)
Static immunity	Destruction: 15 kV Malfunction: 8 kV	
Vibration resistance	Destruction: 10 to 55 Hz, 0.75-mm single amplitude each in three directions Malfunction: 10 to 55 Hz, 0.5-mm single amplitude each in three directions	
Shock resistance	Destruction: 294 m/s ² (30G) each in three directions Malfunction: 98 m/s ² (10G) each in three directions	
Ambient temperature	Operating: -10 to 55 °C (-10 to 50 °C if timers are mounted side by side) (with no icing) Storage: -25 to 65 °C (with no icing)	
Ambient humidity	Operating: 35% to 85%	
Life expectancy	Mechanical: 10,000,000 operations min. Electrical: 100,000 operations min. (3 A at 250 VAC, resistive load)	
EMC	(EMI): EN50081-2 Emission Enclosure: EN55011 Group 1 class A Emission AC Mains: EN55011 Group 1 class A (EMS): EN50082-2 Immunity ESD: EN61000-4-2: 4 kV contact discharge (level 2) 8 kV air discharge (level 3) Immunity RF-interference: ENV50140: 10 V/m (80 MHz to 1 GHz) (level 3) Immunity Conducted Disturbance: ENV50141: 10 V (0.15 to 80 MHz) (level 3) Immunity Burst: EN61000-4-4: 2 kV power-line (level 3) 2 kV I/O signal-line (level 4)	
Case color	Light gray (Munsell 5Y7/1)	
Weight	Approx. 130 g	Approx. 110 g

Note: 1. The values are based on the set value.
2. The value is applied for a minimum pulse width of 1 ms.

Nomenclature

Indicator

1. **Present Value**
Red LEDs with a character height of 12 mm
Note: The decimal point will flash on the present value during the timing operation in the following ranges:
0.1 to 999.9 min, 0 h 01 min to 99 h 59 min, and 0.1 to 999.9 h.
2. **Preset Value**
Green LEDs with a character height of 8 mm
3. **Reset Indicator** (orange)
4. **Key Protection Indicator** (orange)
5. **Time Unit Display** (orange)
6. **Control Output Indicator** (orange)

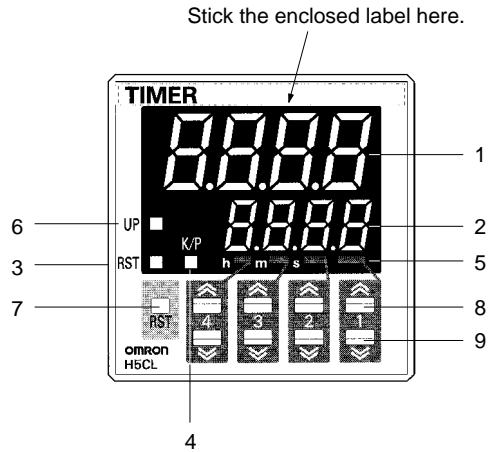

Operation Key

7. **Reset (RST) Key**
The RST Key initializes the present value and control output.
8. **Increment Keys (1 to 4)**
Up Keys 1 to 4 increment the preset value.
9. **Decrement Keys (1 to 4)**
Down Keys 1 to 4 decrement the preset value.

Operation

■ DIP Switch Setting

Pin no.	Item	OFF	ON
1, 2, 3	Time ranges	See table below.	
4	Display modes	Up (Increment)	Down (Decrement)
5	Min. pulse width of inputs	20 ms	1 ms
6	Operating modes	A (signal ON-delay)	F (accumulative operation)

Note: Set the DIP switch before installation and operation of the Unit. DIP switch setting changes are not effective while the power is on.

Time Ranges

1	2	3	Time range
ON	ON	ON	0.001 to 9.999 s
OFF	OFF	OFF	0.01 to 99.99 s
ON	OFF	OFF	0.1 to 999.9 s
OFF	ON	OFF	1 to 9999 s
ON	ON	OFF	0 min 01 s to 99 min 59 s
OFF	OFF	ON	0.1 to 999.9 min
ON	OFF	ON	0 h 01 min to 99 h 59 min
OFF	ON	ON	0.1 to 999.9 h

Note: Switches 1 to 6 are all set to OFF before shipping.

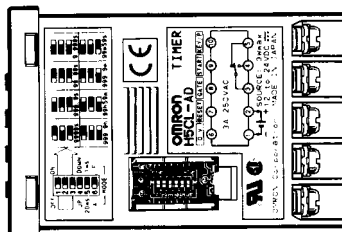

(The same switch settings apply to AC and DC models)

Timer Control with Power Start

When using the H5CL with power start, short-circuit the start input and input 0-V terminals.

■ Operating Modes

A Mode
Signal ON-delay

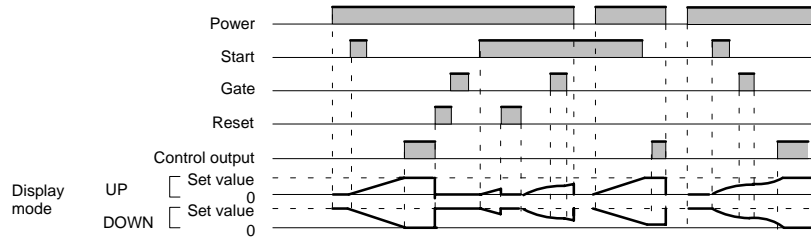

F Mode
Accumulative Operation

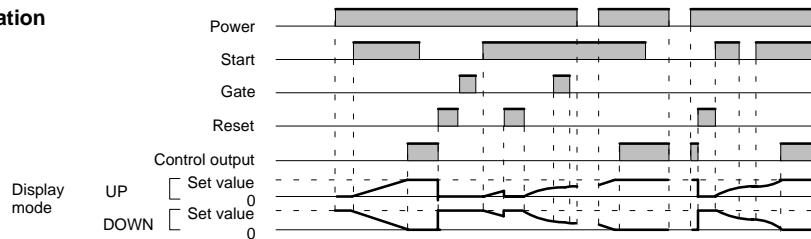

Dimensions

Note: All units are in millimeters unless otherwise indicated.

H5CL-A □

DIN Track/Surface/Flush Mounting

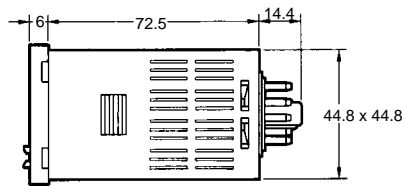
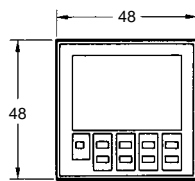
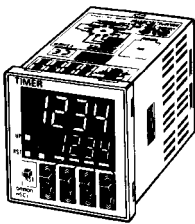

H5CL-AD □

Flush Mounting

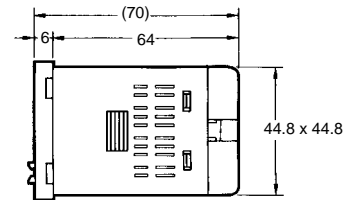
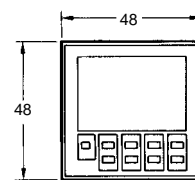
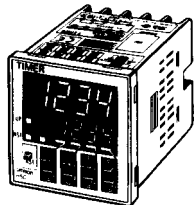

H5CL-A□

With Flush Mounting Adapter

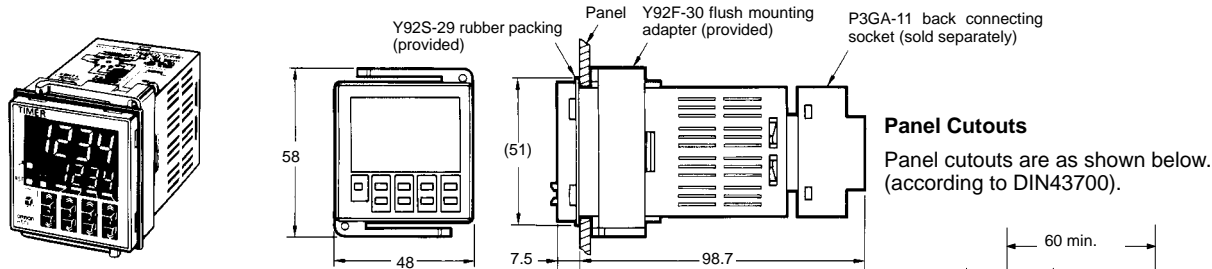

H5CL-AD□

With Flush Mounting Adapter

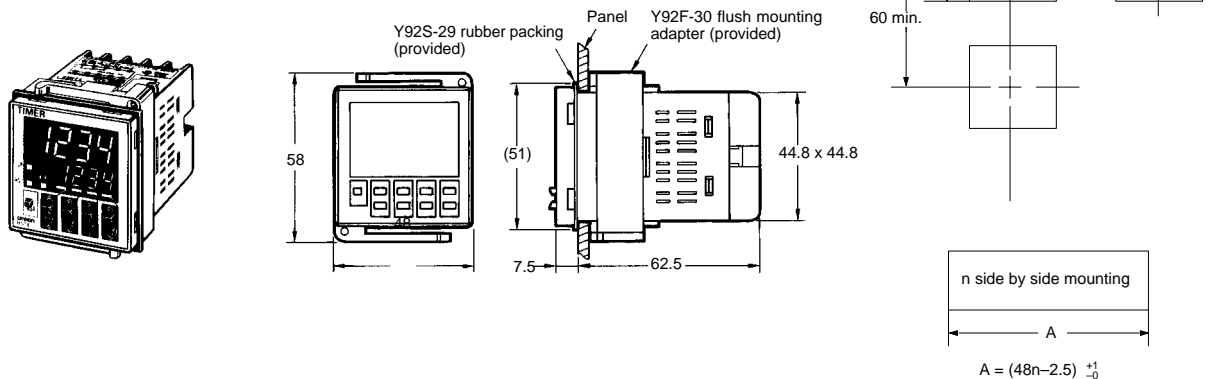

- Note:**
1. The mounting panel thickness should be 1 to 4 mm.
 2. It is possible to mount timers side by side, but only in one direction.
 3. When the Timers are mounted closely side by side, the Timers will not be water-resistive.

DIN Track Mounting

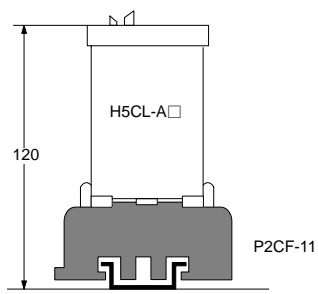

H5CL-AD□-500

The cover conforms to finger protection standard against electric shock. (VDE 0106/P100)

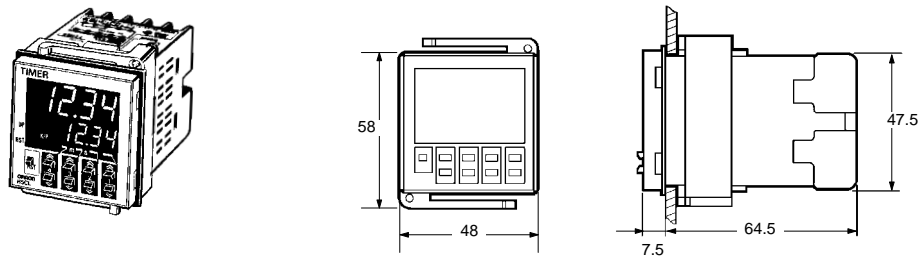

■ Accessories (Order Separately)

**Track Mounting/
Front Connecting Socket
P2CF-11**

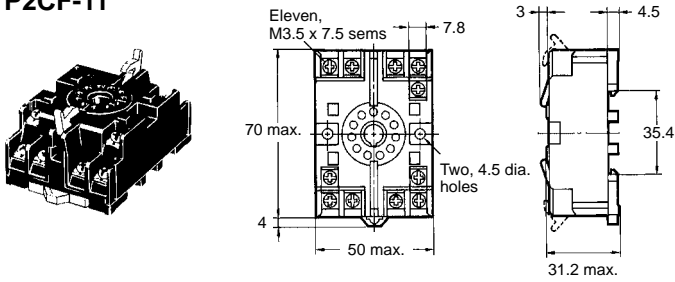

**Terminal Arrangement/
Internal Connections
(Top View)**

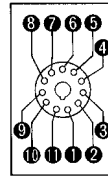

Surface Mounting Holes

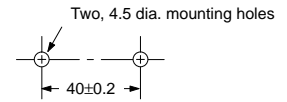

**P2CF-11-E (Finger Safe Terminal Type)
Conforming to VDE0106/P100**

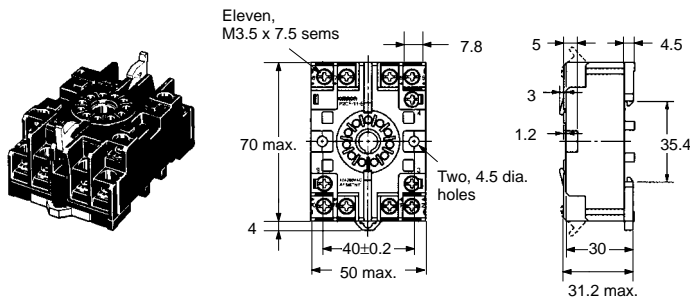

**Back Connecting Socket
P3GA-11**

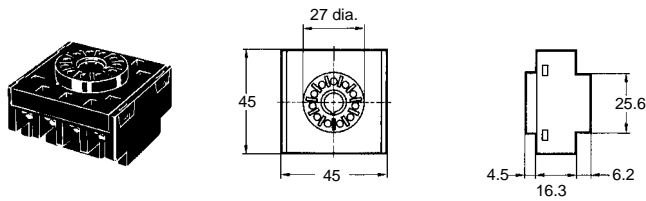

**Terminal Arrangement/
Internal Connections
(Bottom View)**

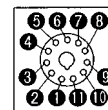

Finger Safe Terminal Cover

Conforming to VDE0106/P100

Y92A-48G

(Attachment for P3GA-11 Socket)

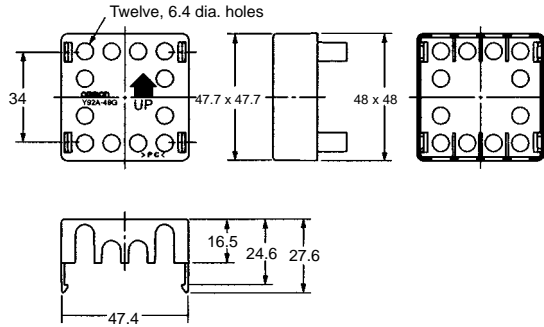
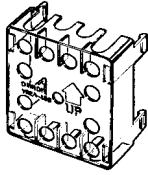

Y92A-48T

(Attachment for H5CL DC models)

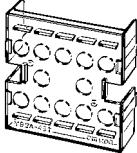

Hard Cover
Y92A-48

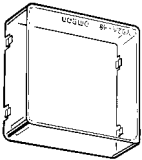

Soft Cover
Y92A-48F1

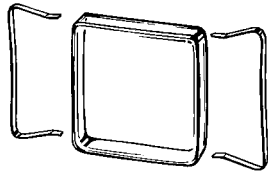

Installation

■ **Terminal Arrangement**

AC Models

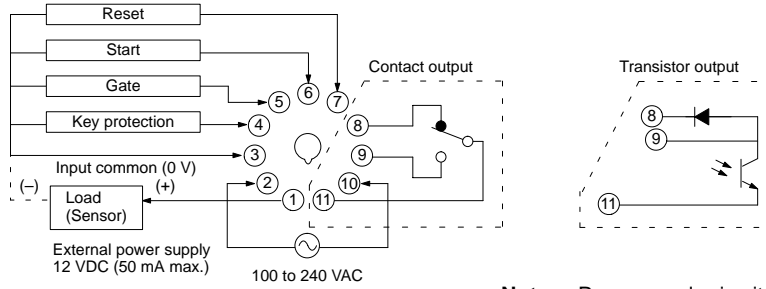

Note: Power supply circuit is insulated from the internal circuit (or I/O).

DC Models

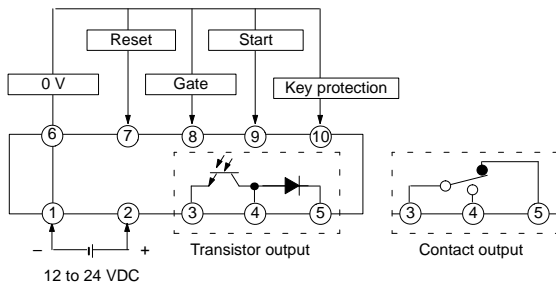

Note: 1 and 6 are connected to each other internally.

Input Circuits

Start, Reset, and Gate Input

H5CL-A□ (AC Models)

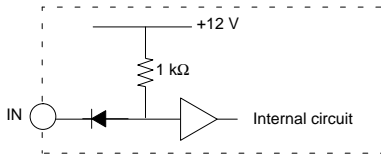

H5CL-AD□ (DC Models)

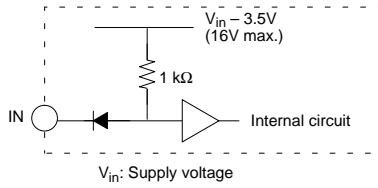

Key Protection Input

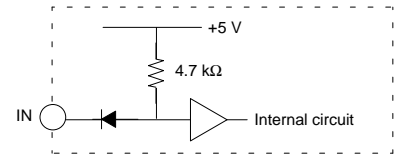

Note: No key input is effective while key protection input is ON.

Input Connections

Open Collector Output

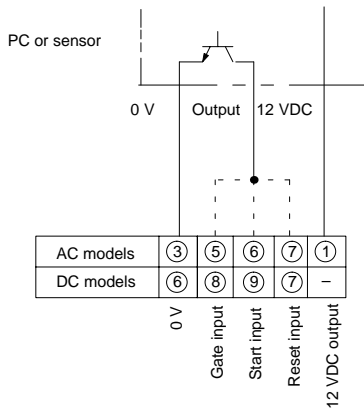

Voltage Output

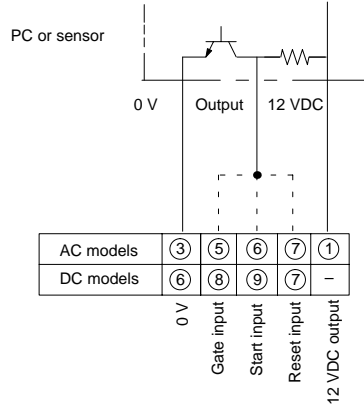

Contact input

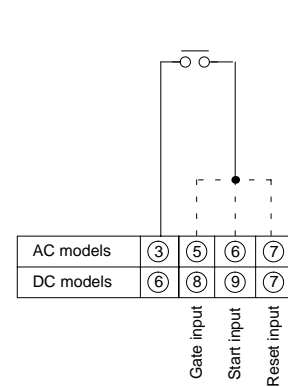

Start, Reset, and Gate Input Specification

ON impedance: 500 Ω max. (the leakage current is 5 to 20 mA when the impedance is 0 Ω.)
 ON residual voltage: 2 V max.
 OFF impedance: 100 kΩ min.
 Maximum applicable voltage: 30 VDC max.

Two-wire Sensor

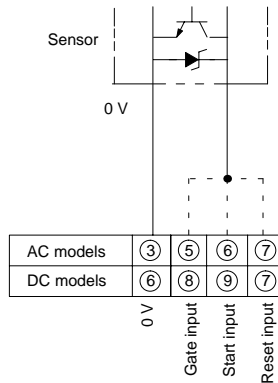

Applicable Two-wire Sensor

Leakage current: 1.5 mA max.
 Switching capacity: 5 mA min.
 Residual voltage: 3 V max.
 Operating voltage: 10 VDC

Note: When connecting a two-wire sensor to a DC models, supply 24 VDC (21.6 to 26.4 VDC) to the timer.

Key Protection Input

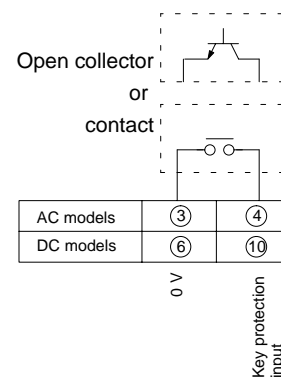

Key Protection Input

ON impedance: 1 kΩ max.
 (the leakage current is approx. 1 mA when the impedance is 0 Ω.)
 ON residual voltage: 0.5 V max.
 OFF impedance: 100 kΩ min.
 Maximum applicable voltage: 30 VDC max.

Note: The used contact should switch 1 mA at 5 V.

Precautions

Power Supplies

When turning the power ON and OFF, input signal reception is possible, unstable, or impossible as shown in the diagram below.

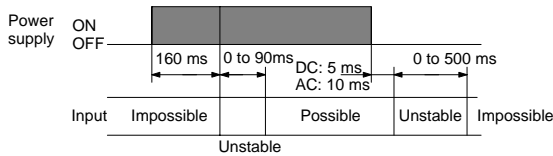

Apply the power supply voltage through a relay or switch in such a way that the voltage reaches a fixed value immediately.

Turn the power ON and OFF with relay with a rated capacity of 10 A minimum to prevent contact deterioration due to inrush current caused by turning the power ON and OFF.

Timer Control with Power Start

The timer cannot take measurements until 160 to 250 ms have elapsed after the power is turned ON (refer to the above chart). The control output will be delayed for any set value less than 250 ms.

When the H5CL is used with power start in F mode (i.e., accumulative operation with output on hold), there will be a timer error (approximately 100 ms each time the H5CL is turned on) due to the characteristics of the internal circuitry.

Use the H5CL with signal start if timer accuracy is required.

Transistor Output

The transistor output of the H5CL is insulated from the internal circuitry by a photocoupler, so the transistor output can be used as both NPN and PNP output.

The diode connected to the collector of the output transistor is used to absorb inverted voltage that is generated when an inductive load is connected to the H5CL.

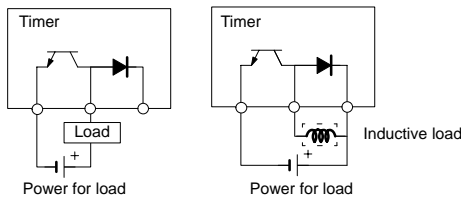

Self-diagnostic Function

The following displays will appear if an error occurs.

Display	Error	Output status	Correction	Set value after correction
E1	CPU	OFF	Press RST Key or turn power off and then ON	No change
E2	Memory (see note)			0

Note: This includes times when the life of the EEPROM has expired.

Operating Environment

When using the Timer in an area with excess electronic noise, separate the Timer, wiring, and the equipment which generates the input signals as far as possible from the noise sources. It is also recommended to shield the input signal wiring to prevent electronic interference.

Organic solvents (such as paint thinner), as well as very acidic or basic solutions can damage the outer casing of the Timer.

Preset Value Change

When changing the preset value during a timing operation, output will turn ON if the preset value is changed as follows, since the constant read-in system is in use:

Display mode UP: Present value \geq preset value
 Display mode DOWN: Elapse time \geq preset value (Present value = 0)

Note: When in down mode, the changed amount of preset value is added to or subtracted from the present value.

Reset with a Preset Value of 0

The output will go ON when the start signal is input. The output will be OFF while the reset key is pressed or the reset input is ON.

Power Failure Backup

All data is stored in the EEPROM when there is power failure. The EEPROM can be overwritten more than 200,000 times.

Operating mode	Overwriting timing
A mode	When the H5CL is turned off after changing the set value.
F mode	When the H5CL is turned off after changing the set value, turning the start input, or the reset input ON.

Flush Mounting

The H5CL's panel surface is water-resistive (conforming to NEMA 4 (indoors) and IP66). In order to prevent the internal circuit from water penetration through the space between the timer and operating panel, attach a rubber packing (provided with the H5CL) between the timer and operating panel and secure the rubber packing with the Y92F-30 flush-mounting adapter.

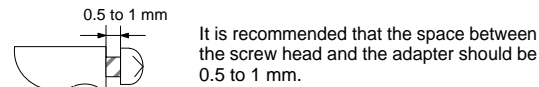

It is recommended that the space between the screw head and the adapter should be 0.5 to 1 mm.

Other

In case of performing a dielectric strength test, etc., on the H5CL mounted to a control panel, disconnect the H5CL from the connecting circuit, or short-circuit all the terminals of the H5CL. Otherwise the H5CL may be damaged.

Terminal 1 (power supply terminal) and terminal 6 (input common: 0 V for input) of DC model H5CL are internally connected to each other.

DIP Switch Selection

DIP switch setting while the H5CL is turned on will not be valid until the H5CL is turned off and on.

ALL DIMENSIONS SHOWN ARE IN MILLIMETERS.

To convert millimeters into inches, multiply by 0.03937. To convert grams into ounces, multiply by 0.03527.

Cat. No. L085-E1-3 **In the interest of product improvement, specifications are subject to change without notice.**

OMRON Corporation

Industrial Automation Company

Measuring and Supervisory Controls Division
28th Fl., Crystal Tower Bldg.,
1-2-27, Shiromi, Chuo-ku,
Osaka 540-6028 Japan
Tel: (81)6-6949-6035 Fax: (81)6-6949-6069

Printed in Japan
1099-0.1M (0696)