

Features

- Improved performance over the TDA2002 (pin-to-pin compatible)
- Very low number of external components
- Ease of assembly
- Cost and space savings

Description

The TDA2003A is capable of providing a high output current (up to 3.5 A) with very low harmonic and crossover distortion.

Completely safe operation is guaranteed due to DC and AC short-circuit protection between all pins and ground, a thermal limiting circuit, load dump voltage surge protection up to 40 V and protection diodes in case of accidental open ground.

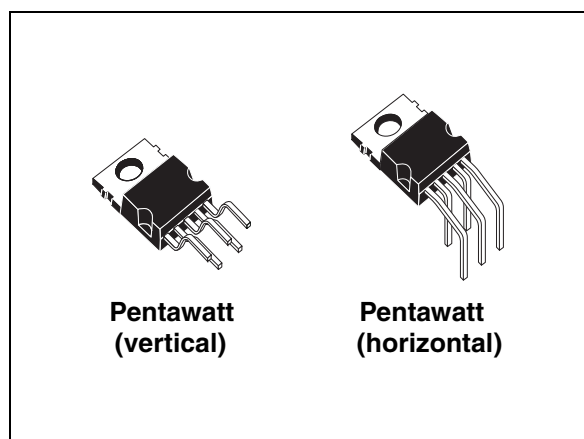

Table 1. Device summary

Order code	Package	Packing
TDA2003AV	Pentawatt (vertical)	Tube
TDA2003AH	Pentawatt (horizontal)	Tube

Contents

- 1 Schematic, test circuits and pin connections 5**
- 2 Electrical specifications 7**
 - 2.1 Absolute maximum ratings 7
 - 2.2 Thermal data 7
 - 2.3 Electrical characteristics 8
 - 2.4 Electrical characteristics curves 9
- 3 Application information 12**
 - 3.1 Built-in protection systems 12
 - 3.1.1 Load dump voltage surge 12
 - 3.1.2 Short-circuit (AC and DC conditions) 13
 - 3.1.3 Polarity inversion 13
 - 3.1.4 Open ground 13
 - 3.1.5 Inductive load 13
 - 3.1.6 DC voltage 13
 - 3.1.7 Thermal shutdown 14
 - 3.2 Practical considerations 14
 - 3.2.1 Printed circuit board 14
 - 3.2.2 Assembly recommendations 14
 - 3.2.3 Application recommendations 15
- 4 Package information 16**
- 5 Revision history 18**

List of tables

Table 1.	Device summary	1
Table 2.	Absolute maximum ratings	7
Table 3.	Thermal data	7
Table 4.	Electrical characteristics	8
Table 5.	Recommended values of the components of a bridge application circuit	15
Table 6.	Document revision history	18

List of figures

Figure 1.	Schematic diagram	5
Figure 2.	DC test circuit	5
Figure 3.	AC test circuit	5
Figure 4.	Pin connections (top view)	6
Figure 5.	Quiescent output voltage vs. supply voltage	9
Figure 6.	Quiescent drain current vs. supply voltage	9
Figure 7.	Output power vs. supply voltage	9
Figure 8.	Output power vs. load resistance R_L	9
Figure 9.	Gain vs. input sensitivity ($R_L = 4 \Omega$)	9
Figure 10.	Gain vs. input sensitivity ($R_L = 2 \Omega$)	9
Figure 11.	Distortion vs. output power	10
Figure 12.	Distortion vs. frequency	10
Figure 13.	Supply voltage rejection vs. voltage gain	10
Figure 14.	Supply voltage rejection vs. frequency	10
Figure 15.	Power dissipation and efficiency vs. output power ($R_L = 4 \Omega$)	10
Figure 16.	Power dissipation and efficiency vs. output power ($R_L = 2 \Omega$)	10
Figure 17.	Maximum power dissipation vs. supply voltage (sine wave operation).	11
Figure 18.	Maximum allowable power dissipation vs. ambient temperature	11
Figure 19.	Typical values of capacitor (C_X) for different values of frequency response (B).	11
Figure 20.	Typical application circuit	12
Figure 21.	Printed circuit board and component layout for typical application circuit.	12
Figure 22.	Voltage gain bridge configuration	13
Figure 23.	Suggested LC network circuit	13
Figure 24.	Output power and drain current vs. case temperature ($R_L = 4 \Omega$)	14
Figure 25.	Output power and drain current vs. case temperature ($R_L = 2 \Omega$)	14
Figure 26.	Pentawatt (vertical) mechanical data and package dimensions	16
Figure 27.	Pentawatt (horizontal) mechanical data and package dimensions.	17

1 Schematic, test circuits and pin connections

Figure 1. Schematic diagram

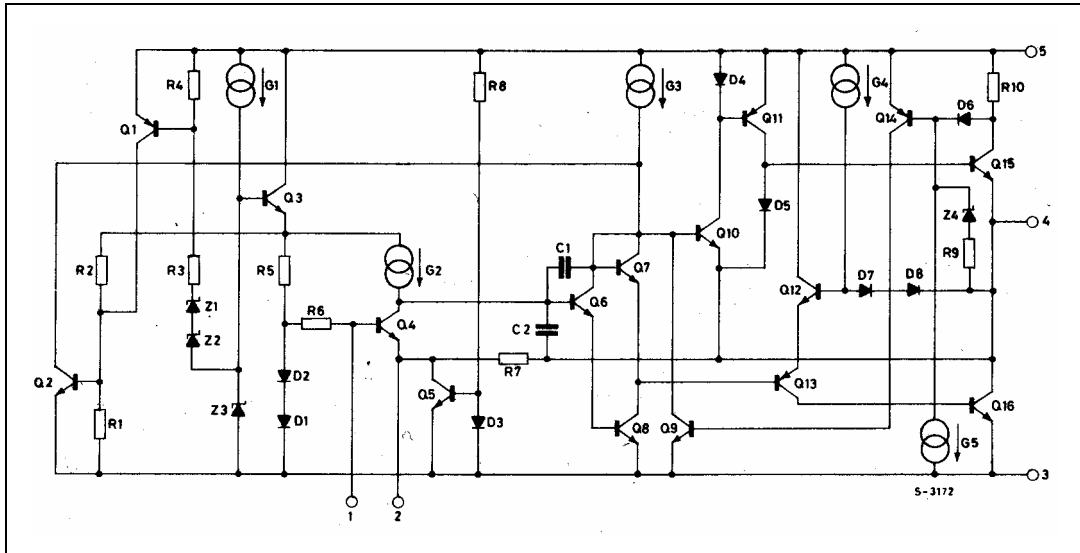

Figure 2. DC test circuit

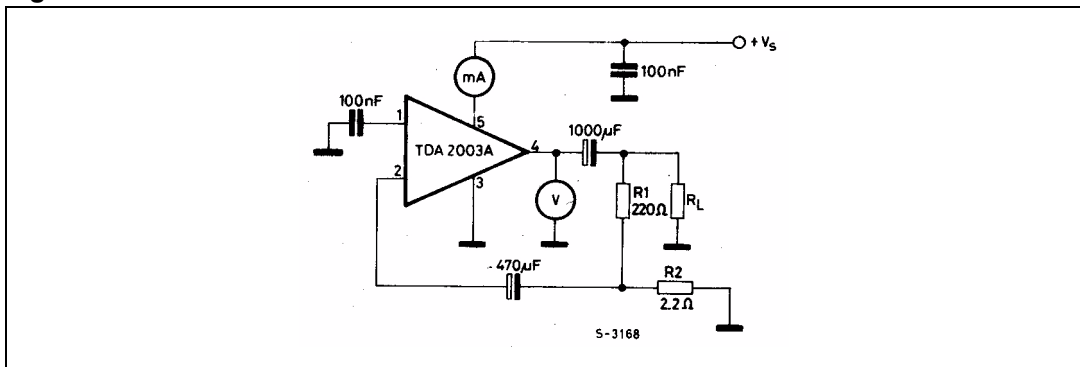

Figure 3. AC test circuit

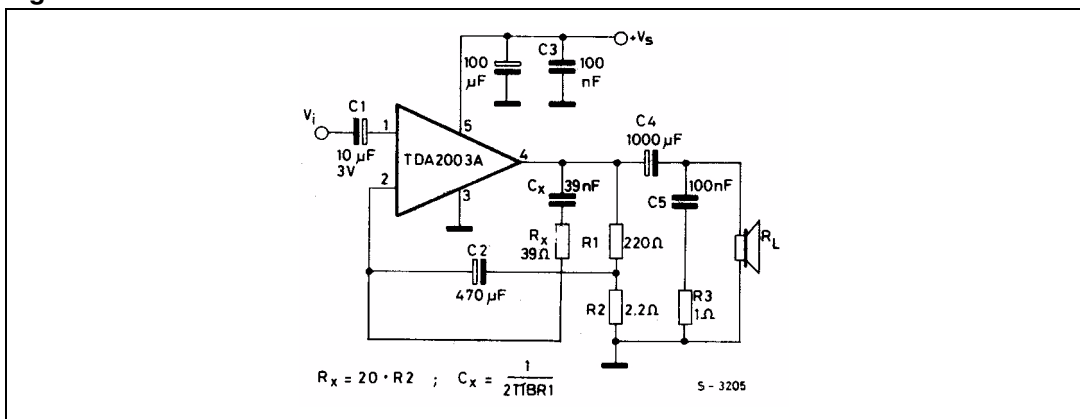
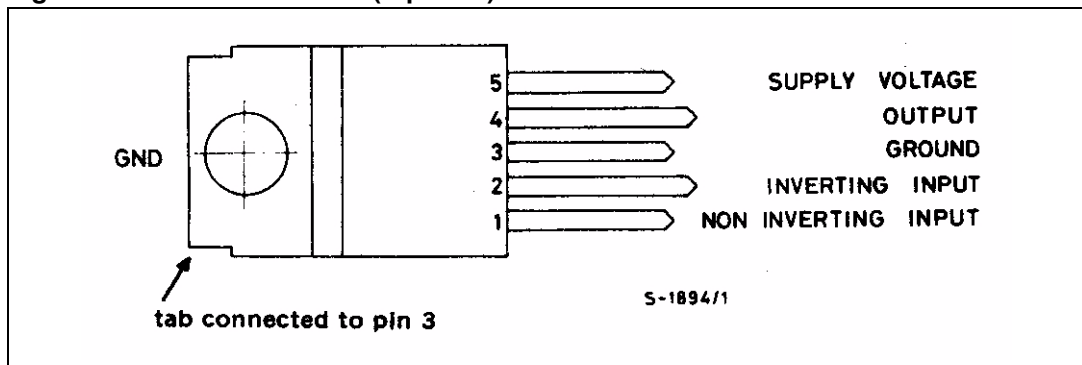

Figure 4. Pin connections (top view)



2 Electrical specifications

2.1 Absolute maximum ratings

Table 2. Absolute maximum ratings

Symbol	Parameter	Value	Unit
Vs	Peak supply voltage (50 ms)	40	V
Vs	DC supply voltage	28	V
Vs	Operating supply voltage	18	V
Io	Output peak current (non-repetitive)	4.5	A
Io	Output peak current (repetitive)	3.5	A
P _{tot}	Power dissipation at T _{case} = 90 °C	20	W
T _{stg} , T _j	Storage and junction temperature	-40 to 150	°C

2.2 Thermal data

Table 3. Thermal data

Symbol	Parameter	Value	Unit
R _{th-j-case}	Thermal resistance junction-to-case	max 3	°C/W

2.3 Electrical characteristics

$V_S = 14.4\text{ V}$, $T_{\text{amb}} = 25\text{ °C}$ unless otherwise specified.

Table 4. Electrical characteristics

Symbol	Parameter	Test condition	Min.	Typ.	Max.	Unit
DC characteristics (refer to DC test circuit)						
V_S	Supply voltage	-	8	-	18	V
V_O	Quiescent output voltage (pin 4)	-	6.1	6.9	7.7	V
I_d	Quiescent drain current (pin 5)	-	-	44	50	mA
AC characteristics (refer to DC test circuit)						
P_o	Output power	d = 10%; f = 1 kHz $R_L = 4\ \Omega$ $R_L = 2\ \Omega$ $R_L = 3.2\ \Omega$ $R_L = 1.6\ \Omega$	5.5 9	6 10 7.5 12	-	W
$V_{i(\text{rms})}$	Input saturation voltage	-	300			mV
V_i	Input sensitivity	f = 1 kHz $R_L = 4\ \Omega$; $P_o = 0.5\text{ W}$; $R_L = 4\ \Omega$; $P_o = 6\text{ W}$; $R_L = 2\ \Omega$; $P_o = 0.5\text{ W}$; $R_L = 2\ \Omega$; $P_o = 10\text{ W}$;	-	14 55 10 50	-	mW
B	Frequency response (-3 dB)	$R_L = 4\ \Omega$; $P_o = 1\text{ W}$;	40 to 15,000			Hz
d	Distortion	f = 1 kHz $R_L = 4\ \Omega$; $P_o = 0.05\text{ to }4.5\text{ W}$; $R_L = 2\ \Omega$; $P_o = 0.05\text{ to }7.5\text{ W}$;	-	0.15 0.15	-	%
R_i	Input resistance	f = 1 kHz	70	150	-	k Ω
G_v	Voltage gain (open loop)	f = 1 kHz; f = 10 kHz	-	80 60	-	dB dB
G_v	Voltage gain (closed loop)	f = 1 kHz; $R_L = 4\ \Omega$	39.3	40	40.3	dB
e_N	Input noise voltage ⁽¹⁾	-	-	1	5	μV
i_N	Input noise current ⁽¹⁾	-	-	60	200	pA
h	Efficiency	f = 1 kHz $R_L = 4\ \Omega$; $P_o = 6\text{ W}$; $R_L = 2\ \Omega$; $P_o = 10\text{ W}$;	-	69 65	-	% %
SVR	Supply voltage rejection	f = 100 Hz; $V_{\text{ripple}} = 0.5\text{ V}$; $R_g = 10\text{ k}\Omega$; $R_L = 4\ \Omega$;	30	36	-	dB

1. Filter with noise bandwidth: 22 Hz to 22 kHz.

2.4 Electrical characteristics curves

Figure 5. Quiescent output voltage vs. supply voltage

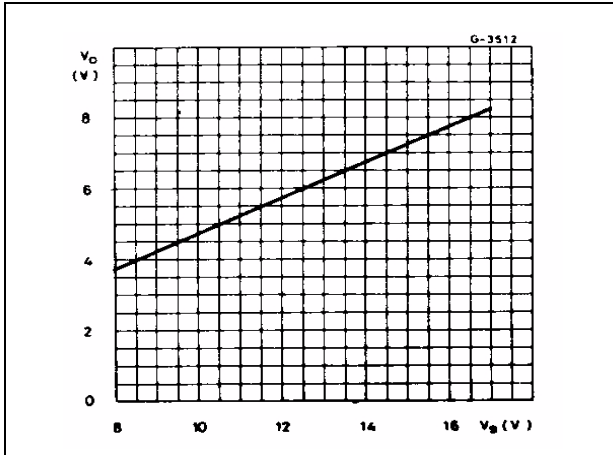

Figure 6. Quiescent drain current vs. supply voltage

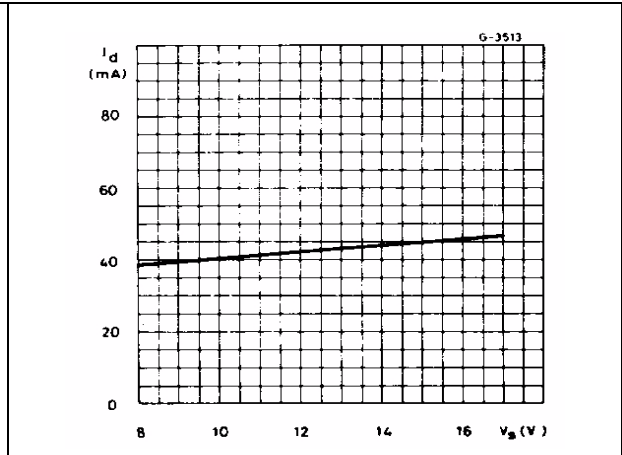

Figure 7. Output power vs. supply voltage

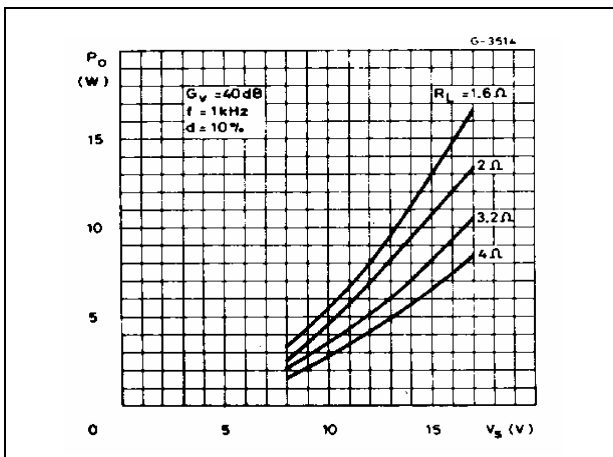

Figure 8. Output power vs. load resistance R_L

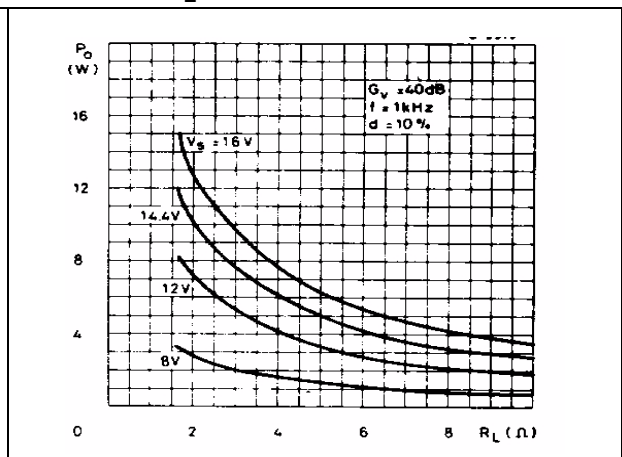

Figure 9. Gain vs. input sensitivity ($R_L = 4\Omega$)

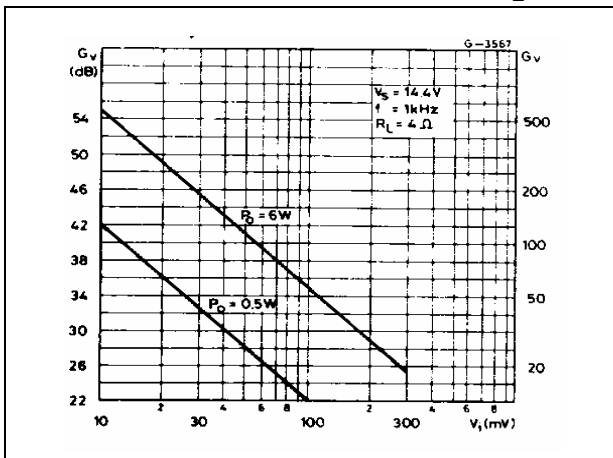

Figure 10. Gain vs. input sensitivity ($R_L = 2\Omega$)

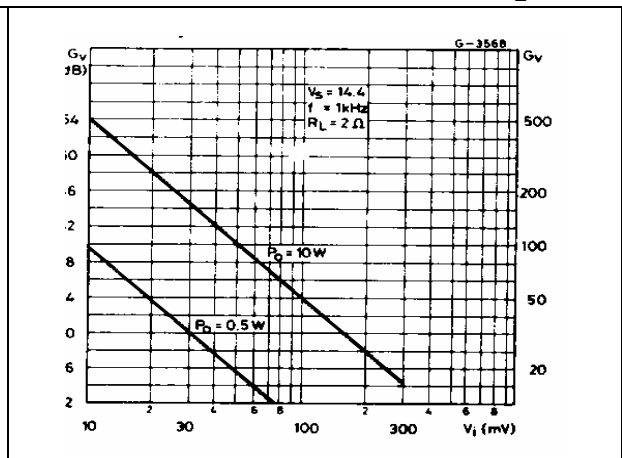

Figure 11. Distortion vs. output power

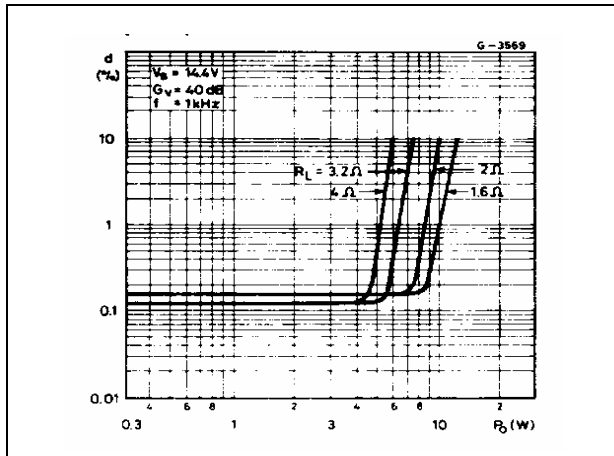

Figure 12. Distortion vs. frequency

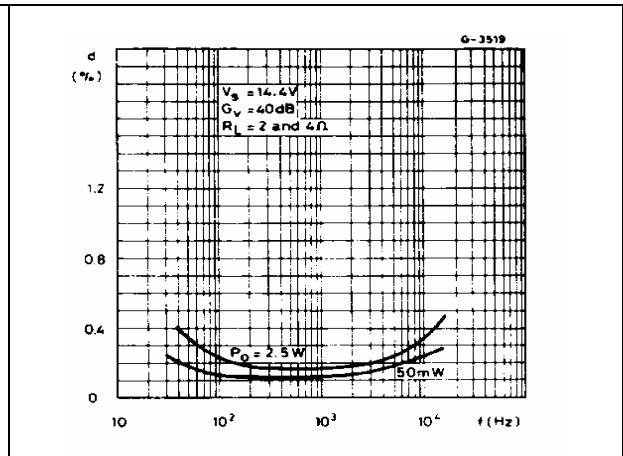

Figure 13. Supply voltage rejection vs. voltage gain

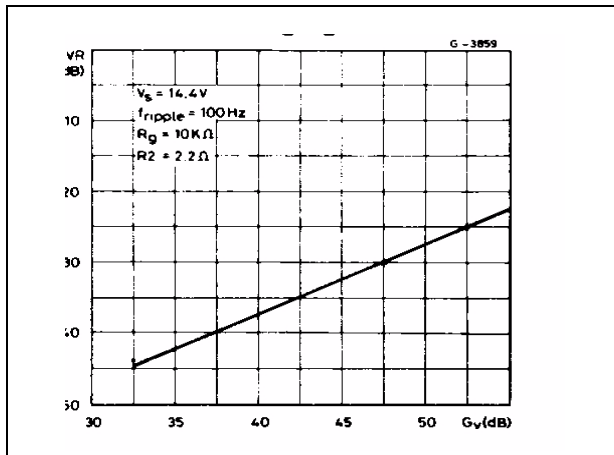

Figure 14. Supply voltage rejection vs. frequency

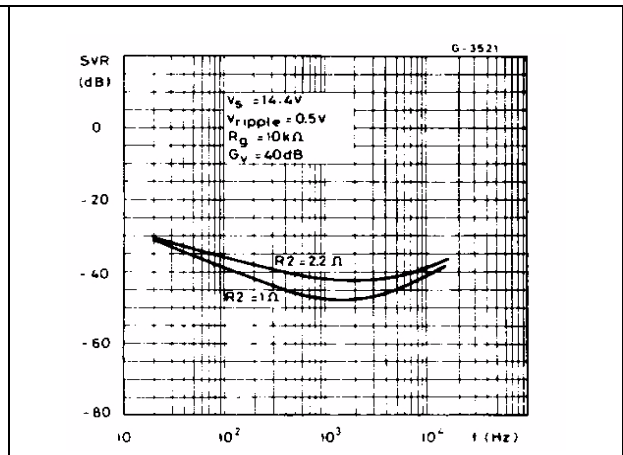

Figure 15. Power dissipation and efficiency vs. output power ($R_L = 4 \Omega$)

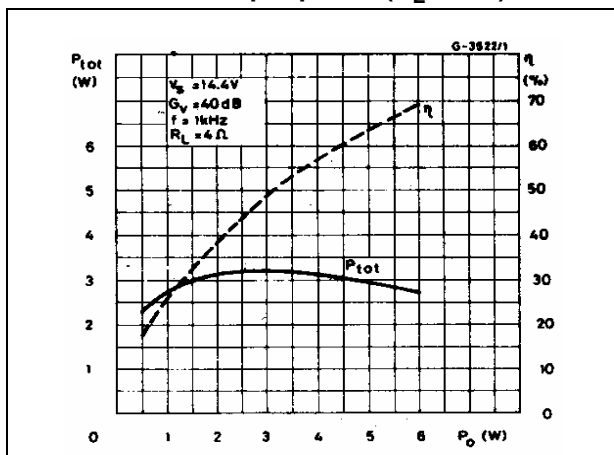

Figure 16. Power dissipation and efficiency vs. output power ($R_L = 2 \Omega$)

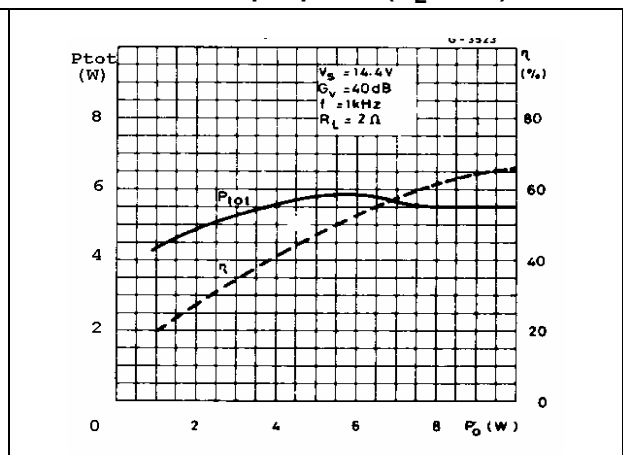

Figure 17. Maximum power dissipation vs. supply voltage (sine wave operation)

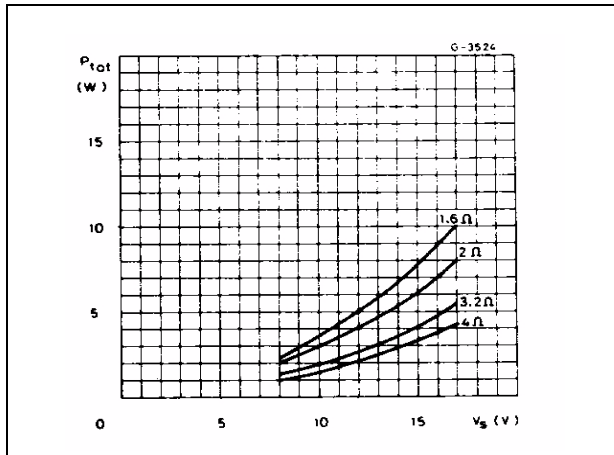

Figure 18. Maximum allowable power dissipation vs. ambient temperature

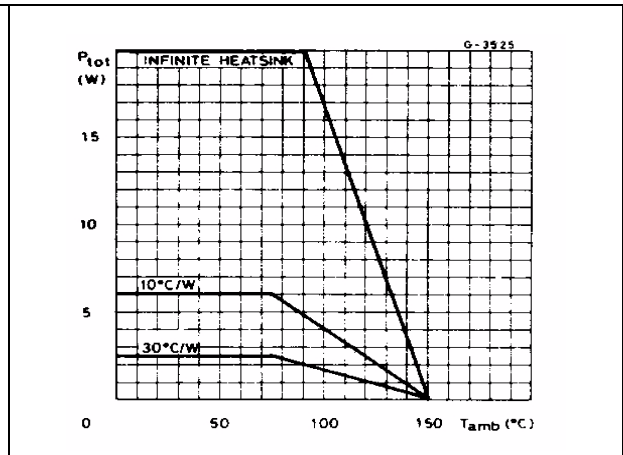
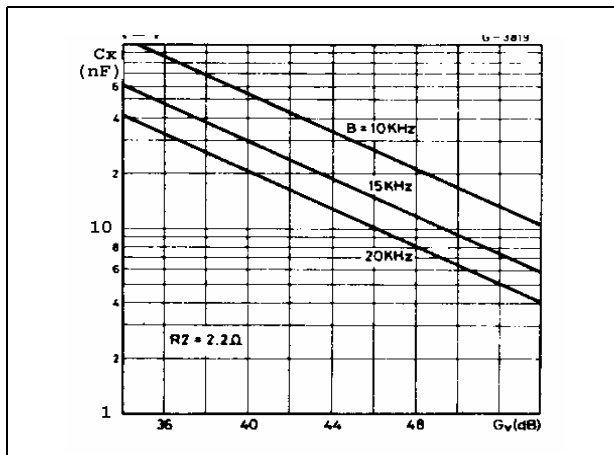

Figure 19. Typical values of capacitor (C_x) for different values of frequency response (B)



3 Application information

Figure 20. Typical application circuit

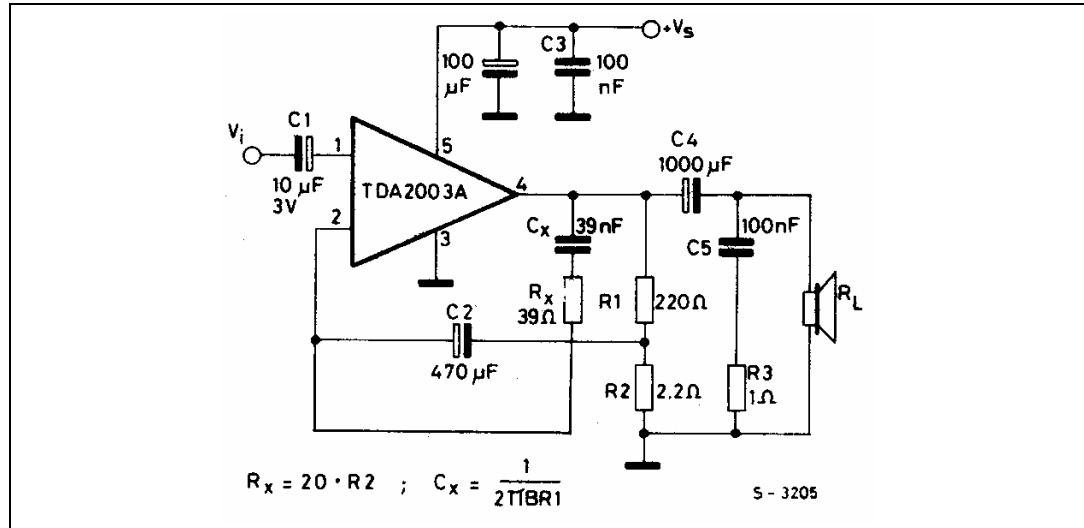
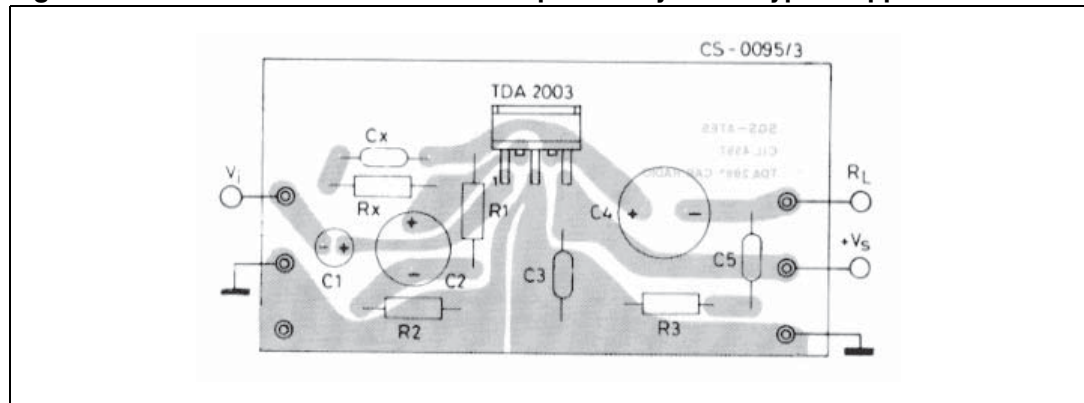

Figure 21. Printed circuit board and component layout for typical application circuit



3.1 Built-in protection systems

3.1.1 Load dump voltage surge

The TDA2003A has a circuit which enables it to withstand a voltage pulse train, on pin 5, of the type shown in [Figure 23](#).

If the supply voltage peaks to more than 40 V, then an LC filter must be inserted between the supply and pin 5, in order to ensure that the pulses at pin 5 will be held within the limits shown in [Figure 22](#).

A recommended LC network is shown in [Figure 23](#). With this network, a train of pulses with amplitude up to 120 V and width of 2 ms can be applied at point A.

This type of protection is ON when the supply voltage (pulsed or DC) exceeds 18 V. For this reason the maximum operating supply voltage is 18 V.

Figure 22. Voltage gain bridge configuration

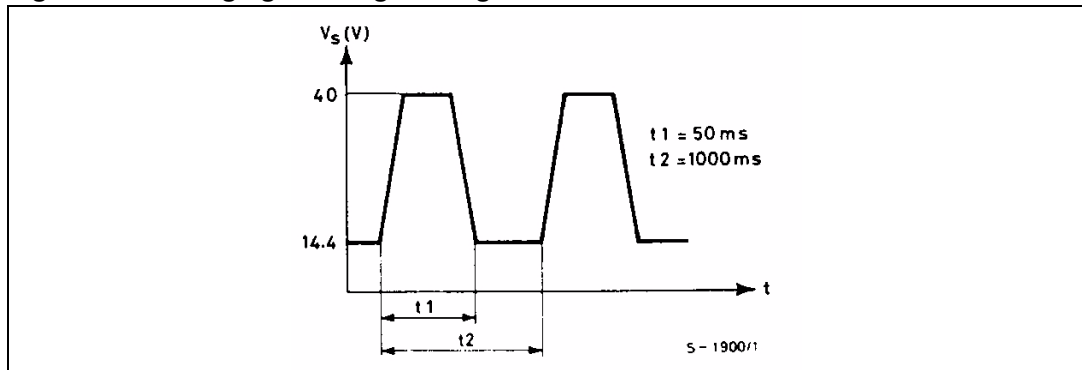
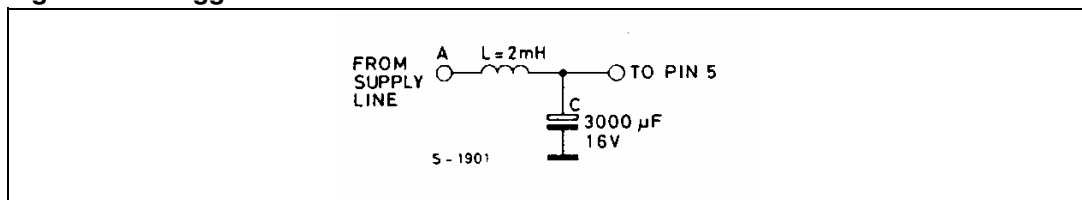

Figure 23. Suggested LC network circuit



3.1.2 Short-circuit (AC and DC conditions)

The TDA2003A can withstand a permanent short-circuit on the output for a supply voltage up to 16 V.

3.1.3 Polarity inversion

High current (up to 5 A) can be handled by the device with no damage for a longer period than the blow-out time of a quick 1 A fuse (normally connected in series with the supply).

This feature is added to avoid destruction if, during fitting to the car, a mistake on the connection of the supply is made.

3.1.4 Open ground

When the radio is in the ON condition and the ground is accidentally opened, a standard audio amplifier will be damaged. On the TDA2003A, protection diodes are included to avoid any damage.

3.1.5 Inductive load

A protection diode is provided between pin 4 and 5 (see the internal schematic diagram) to allow use of the TDA2003A with inductive loads. In particular, the TDA2003A can drive a coupling transformer for audio modulation.

3.1.6 DC voltage

The maximum operating DC voltage on the TDA2003A is 18 V, however the device can withstand a DC voltage up to 28 V with no damage. This could occur during winter if two batteries were connected in series to crank the engine.

3.1.7 Thermal shutdown

The presence of a thermal limiting circuit offers the following advantages:

1. An overload on the output (even if it is permanent), or an excessive ambient temperature can be easily withstood.
2. The heatsink can have a smaller factor compared with that of a conventional circuit. There is no damage to the device in the case of excessive junction temperature: only P_o (and therefore P_{tot}) and I_d are reduced.

Figure 24. Output power and drain current vs. case temperature ($R_L = 4 \Omega$) **Figure 25. Output power and drain current vs. case temperature ($R_L = 2 \Omega$)**

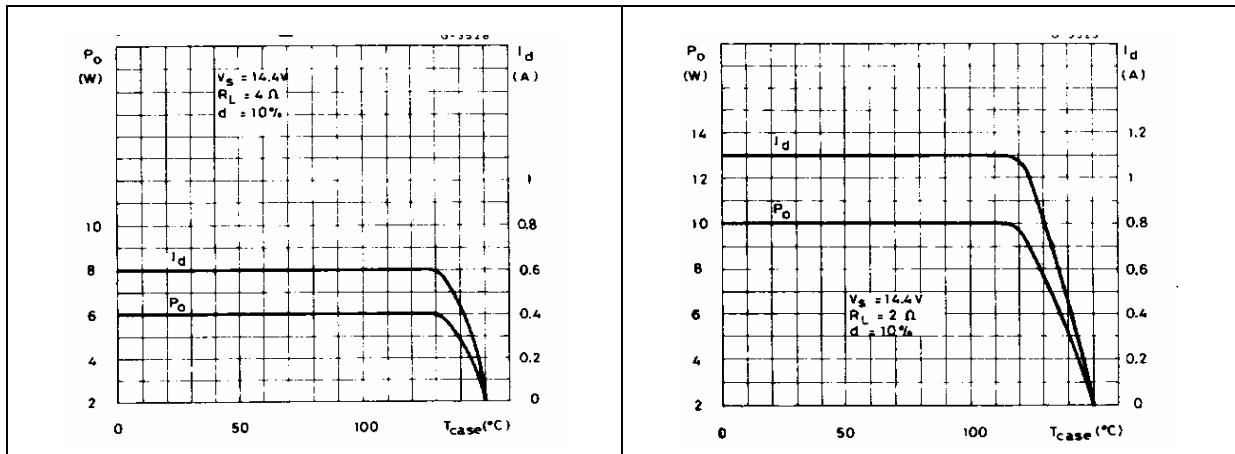

3.2 Practical considerations

3.2.1 Printed circuit board

The layout shown in [Figure 21](#) is recommended. If different layouts are used, the ground points of input 1 and input 2 must be well decoupled from the ground of the output through which a rather high current flows.

3.2.2 Assembly recommendations

No electrical insulation is required between the package and the heatsink. Pin length should be as short as possible. The soldering temperature must not exceed $260^{\circ}C$ for 12 seconds.

3.2.3 Application recommendations

The recommended component values are those shown in the application circuit in [Figure 20](#). Different values can be used. The following table is intended to aid the car-radio designer.

Table 5. Recommended values of the components of a bridge application circuit

Component	Recommended value	Purpose	Larger than recommended value	Smaller than recommended value C1
C1	2.2 μ F	Input DC decoupling	-	Noise at switch-on, switch-off
C2	470 μ F	Ripple rejection	-	Degradation of SVR
C3	0.1 μ F	Supply bypassing	-	Danger of oscillation
C4	1000 μ F	Output coupling to load	-	Higher low frequency cutoff
C5	0.1 μ F	Frequency stability	-	Danger of oscillation at high frequencies with inductive loads
C _x	$\cong \frac{1}{2\pi BR1}$	Upper frequency cutoff	Lower bandwidth	Larger bandwidth
R1	(Gv-1). R2	Setting of gain	-	Increase of drain current
R2	2.2 Ω	Setting of gain and SVR	Degradation of SVR	-
R3	1 Ω	Frequency stability	Danger of oscillation at high frequencies with inductive loads	-
R _x	$\cong 20 R2$	Upper frequency cutoff	Poor high frequency attenuation	Danger of oscillation

4 Package information

In order to meet environmental requirements, ST offers these devices in different grades of ECOPACK® packages, depending on their level of environmental compliance. ECOPACK® specifications, grade definitions and product status are available at: www.st.com.

ECOPACK® is an ST trademark.

Figure 26. Pentawatt (vertical) mechanical data and package dimensions

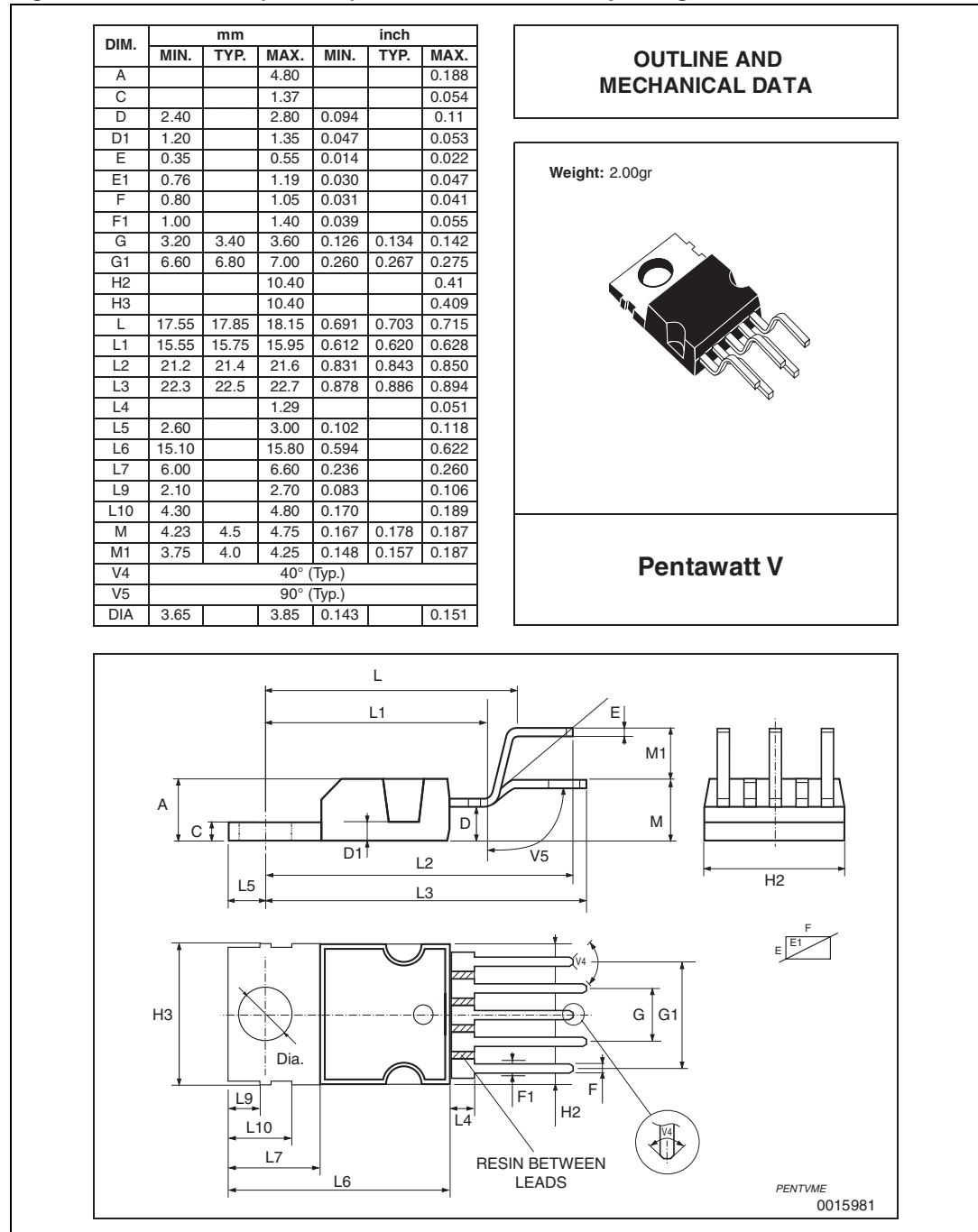
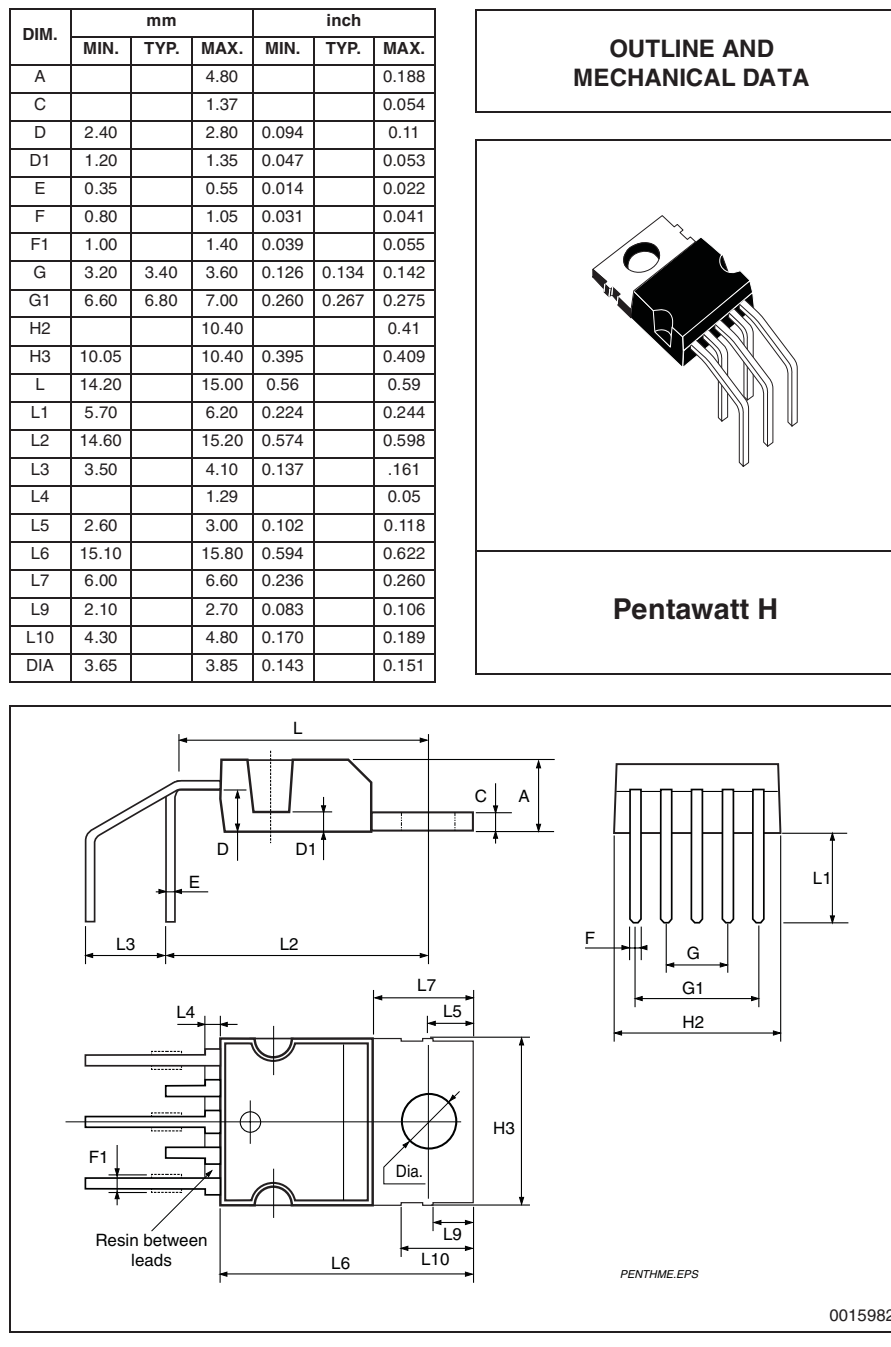

Figure 27. Pentawatt (horizontal) mechanical data and package dimensions



5 Revision history

Table 6. Document revision history

Date	Revision	Changes
02-May-2011	1	Initial release.
14-Jun-2011	2	Removed minimum value from Pentawatt (vertical) package dimension H3 (Figure 26).
05-Jul-2012	3	Updated frequency response in Table 4: Electrical characteristics
23-Jul-2012	4	Updated e_N (max) in Table 4: Electrical characteristics

Please Read Carefully:

Information in this document is provided solely in connection with ST products. STMicroelectronics NV and its subsidiaries ("ST") reserve the right to make changes, corrections, modifications or improvements, to this document, and the products and services described herein at any time, without notice.

All ST products are sold pursuant to ST's terms and conditions of sale.

Purchasers are solely responsible for the choice, selection and use of the ST products and services described herein, and ST assumes no liability whatsoever relating to the choice, selection or use of the ST products and services described herein.

No license, express or implied, by estoppel or otherwise, to any intellectual property rights is granted under this document. If any part of this document refers to any third party products or services it shall not be deemed a license grant by ST for the use of such third party products or services, or any intellectual property contained therein or considered as a warranty covering the use in any manner whatsoever of such third party products or services or any intellectual property contained therein.

UNLESS OTHERWISE SET FORTH IN ST'S TERMS AND CONDITIONS OF SALE ST DISCLAIMS ANY EXPRESS OR IMPLIED WARRANTY WITH RESPECT TO THE USE AND/OR SALE OF ST PRODUCTS INCLUDING WITHOUT LIMITATION IMPLIED WARRANTIES OF MERCHANTABILITY, FITNESS FOR A PARTICULAR PURPOSE (AND THEIR EQUIVALENTS UNDER THE LAWS OF ANY JURISDICTION), OR INFRINGEMENT OF ANY PATENT, COPYRIGHT OR OTHER INTELLECTUAL PROPERTY RIGHT.

UNLESS EXPRESSLY APPROVED IN WRITING BY TWO AUTHORIZED ST REPRESENTATIVES, ST PRODUCTS ARE NOT RECOMMENDED, AUTHORIZED OR WARRANTED FOR USE IN MILITARY, AIR CRAFT, SPACE, LIFE SAVING, OR LIFE SUSTAINING APPLICATIONS, NOR IN PRODUCTS OR SYSTEMS WHERE FAILURE OR MALFUNCTION MAY RESULT IN PERSONAL INJURY, DEATH, OR SEVERE PROPERTY OR ENVIRONMENTAL DAMAGE. ST PRODUCTS WHICH ARE NOT SPECIFIED AS "AUTOMOTIVE GRADE" MAY ONLY BE USED IN AUTOMOTIVE APPLICATIONS AT USER'S OWN RISK.

Resale of ST products with provisions different from the statements and/or technical features set forth in this document shall immediately void any warranty granted by ST for the ST product or service described herein and shall not create or extend in any manner whatsoever, any liability of ST.

ST and the ST logo are trademarks or registered trademarks of ST in various countries.

Information in this document supersedes and replaces all information previously supplied.

The ST logo is a registered trademark of STMicroelectronics. All other names are the property of their respective owners.

© 2012 STMicroelectronics - All rights reserved

STMicroelectronics group of companies

Australia - Belgium - Brazil - Canada - China - Czech Republic - Finland - France - Germany - Hong Kong - India - Israel - Italy - Japan - Malaysia - Malta - Morocco - Philippines - Singapore - Spain - Sweden - Switzerland - United Kingdom - United States of America

www.st.com

