

FFD20UP20S

Features

- Ultrafast with soft recovery, $t_{rr} < 45\text{ns}$
- Reverse Voltage, $V_{RRM}=200\text{V}$
- Forward Voltage $< 1.05\text{V}$ @ $T_C = 100^\circ\text{C}$
- RoHS compliant

Applications

- Power switching circuits
- Output rectifiers
- Freewheeling diodes
- Switching mode power supply

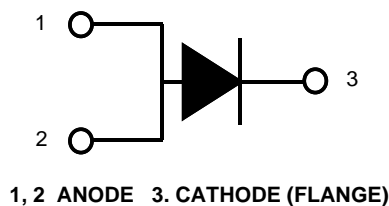
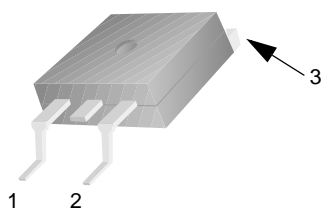

Absolute Maximum Ratings $T_C = 25^\circ\text{C}$ unless otherwise noted

Symbol	Parameter	Ratings	Units
V_{RRM}	Peak Repetitive Reverse Voltage	200	V
$I_{F(AV)}$	Average Rectified Forward Current @ $T_C = 123^\circ\text{C}$	20	A
I_{FSM}	Non-repetitive Peak Surge Current 60Hz Single Half-Sine Wave	200	A
T_J, T_{STG}	Operating and Storage Temperature Range	-65 to +150	$^\circ\text{C}$

Thermal Characteristics

Symbol	Parameter	Ratings	Units
$R_{\theta JC}$	Maximum Thermal Resistance, Junction to Case	1.9	$^\circ\text{C/W}$

Package Marking and Ordering Information

Device Marking	Device	Package	Reel Size	Tape Width	Quantity
F20UP20S	FFD20UP20S	D-PAK	13" Dia	-	2500

Electrical Characteristics $T_C = 25^\circ\text{C}$ unless otherwise noted

Symbol	Parameter	Min.	Typ.	Max.	Units
V_{FM}^*	Maximum Instantaneous Forward Voltage				
	$I_F = 20\text{A}$ $T_C = 25^\circ\text{C}$	-	0.94	1.15	V
	$I_F = 20\text{A}$ $T_C = 100^\circ\text{C}$	-	0.84	1.05	
I_{RM}^*	Maximum Instantaneous Reverse Current @ rated V_R	$T_C = 25^\circ\text{C}$	-	100	μA
		$T_C = 100^\circ\text{C}$	-	500	
t_{rr}	Reverse Recovery Time ($I_F = 20\text{A}$, $di/dt = 200\text{A}/\mu\text{s}$)	-	22	45	ns
W_{AVL}	Avalanche Energy ($L = 40\text{mH}$)	20	-	-	mJ

* Pulse Test: Pulse Width = 300 μs , Duty Cycle = 2%

*

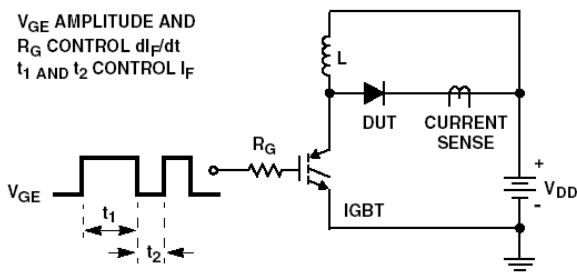

t_{rr} TEST CIRCUIT

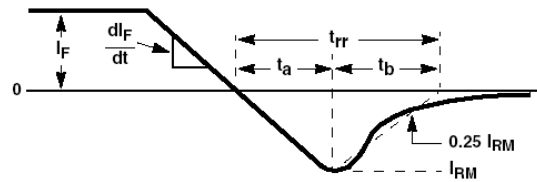

t_{rr} WAVEFORMS AND DEFINITIONS

$I_{MAX} = 1\text{A}$
 $L = 40\text{mH}$
 $R < 0.1\Omega$
 $E_{AVL} = 1/2LI^2 [V_{R(AVL)}/(V_{R(AVL)} - V_{DD})]$
 $Q_1 = \text{IGBT (}BV_{CES} > \text{DUT } V_{R(AVL)})$

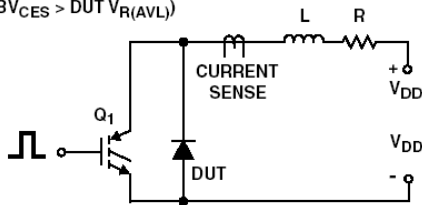

AVALANCHE ENERGY TEST CIRCUIT

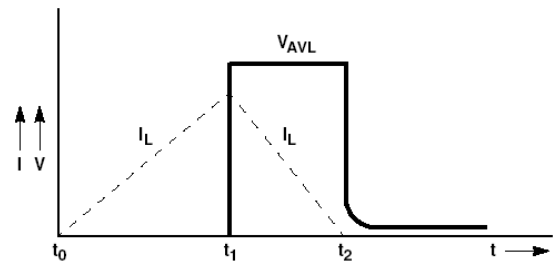

AVALANCHE CURRENT AND VOLTAGE WAVEFORMS

Test Circuit and Waveforms

Typical Performance Characteristics

Figure 1. Typical Forward Voltage Drop vs. Forward Current

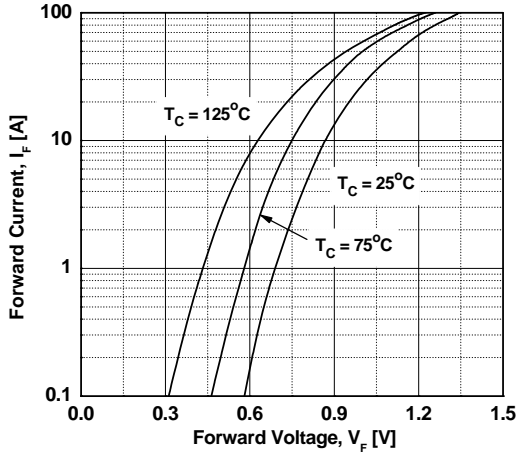

Figure 3. Typical Junction Capacitance

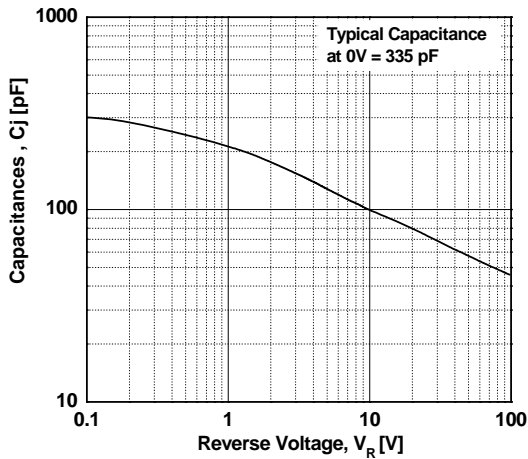

Figure 5. Typical Reverse Recovery Current vs. di/dt

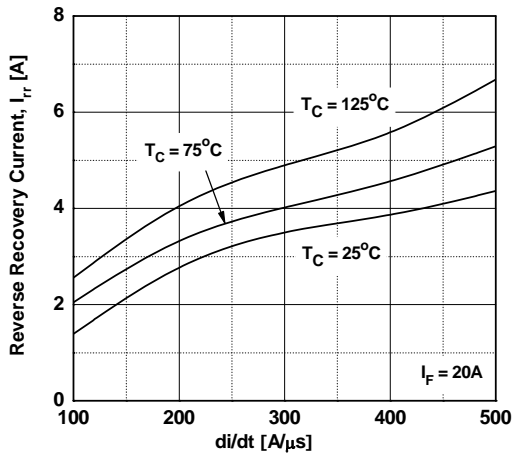

Figure 2. Typical Reverse Current vs. Reverse Voltage

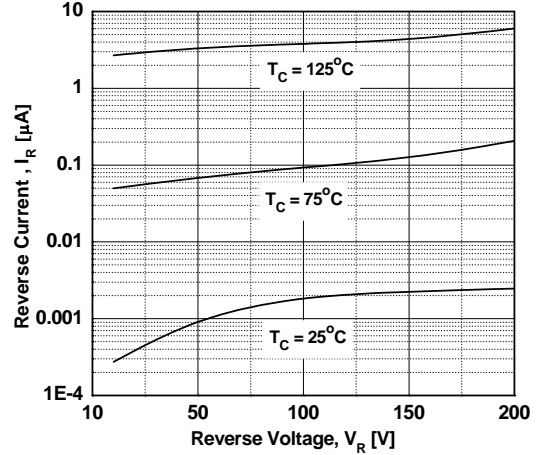

Figure 4. Typical Reverse Recovery Time vs. di/dt

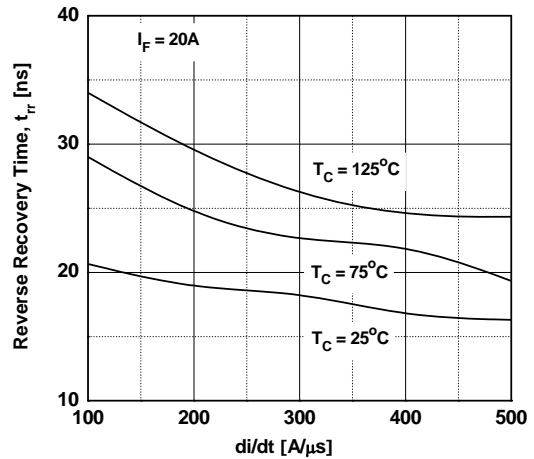
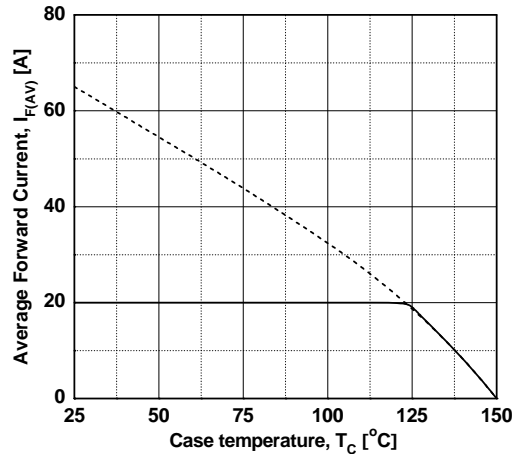
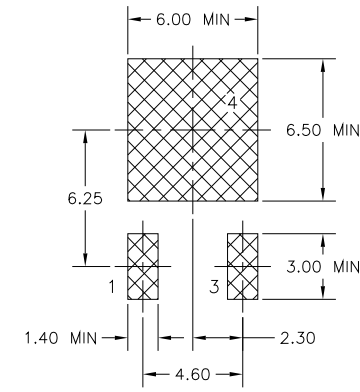
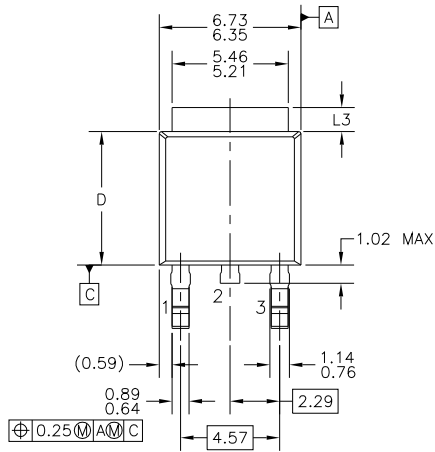

Figure 6. Forward Current Derating Curve



Mechanical Dimensions

D-PAK



LAND PATTERN RECOMMENDATION

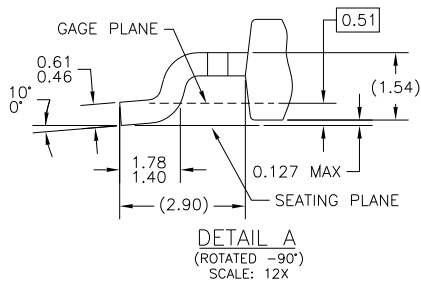
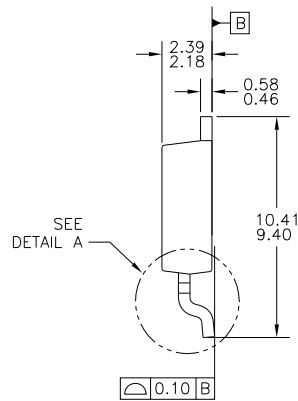
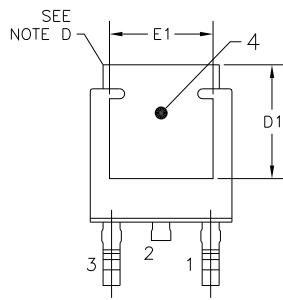



- NOTES: UNLESS OTHERWISE SPECIFIED
- A) ALL DIMENSIONS ARE IN MILLIMETERS.
 - B) THIS PACKAGE CONFORMS TO JEDEC, TO-252, ISSUE C, VARIATION AA & AB, DATED NOV. 1999.
 - C) DIMENSIONING AND TOLERANCING PER ASME Y14.5M-1994.
 - D) HEAT SINK TOP EDGE COULD BE IN CHAMFERED CORNERS OR EDGE PROTRUSION.
 - E) DIMENSIONS L3,D,E1&D1 TABLE:
- | | OPTION AA | OPTION AB |
|----|-----------|-----------|
| L3 | 0.89-1.27 | 1.52-2.03 |
| D | 5.97-6.22 | 5.33-5.59 |
| E1 | 4.32 MIN | 3.81 MIN |
| D1 | 5.21 MIN | 4.57 MIN |
- F) PRESENCE OF TRIMMED CENTER LEAD IS OPTIONAL.

Dimensions in Millimeters



TRADEMARKS

The following includes registered and unregistered trademarks and service marks, owned by Fairchild Semiconductor and/or its global subsidiaries, and is not intended to be an exhaustive list of all such trademarks.

- | | | | |
|---|---|---|---|
| Auto-SPM™ | F-PFST™ | PowerTrench® | The Power Franchise® |
| Build it Now™ | FRFET® | PowerXS™ | the power franchise® |
| CorePLUS™ | Global Power ResourceSM | Programmable Active Droop™ | TinyBoost™ |
| CorePOWER™ | Green FPS™ | QFET® | TinyBuck™ |
| CROSSVOLT™ | Green FPS™ e-Series™ | QS™ | TinyLogic® |
| CTL™ | Gmax™ | Quiet Series™ | TINYOPTO™ |
| Current Transfer Logic™ | GTO™ | RapidConfigure™ | TinyPower™ |
| EcoSPARK® | IntelliMAX™ |  ™ | TinyPWM™ |
| EfficientMax™ | ISOPLANAR™ | Saving our world, 1mW /W /kW at a time™ | TinyWire™ |
| EZSWITCH™ * | MegaBuck™ | SmartMax™ | TriFault Detect™ |
|  ™ | MICROCOUPLER™ | SMART START™ | TRUECURRENT™* |
|  ™ | MicroFET™ | SPM® | µSerDes™ |
| Fairchild® | MicroPak™ | STEALTH™ |  ™ |
| Fairchild Semiconductor® | MillerDrive™ | SuperFET™ | UHC® |
| FACT Quiet Series™ | MotionMax™ | SuperSOT™-3 | Ultra FRFET™ |
| FACT® | Motion-SPM™ | SuperSOT™-6 | UniFET™ |
| FAST® | OPTOLOGIC® | SuperSOT™-8 | VCX™ |
| FastvCore™ | OPTOPLANAR® | SupreMOS™ | VisualMax™ |
| FETBench™ |  ™ | SyncFET™ | XS™ |
| FlashWriter® * | PDP SPM™ | Sync-Lock™ | |
| FPS™ | Power-SPM™ |  ™ | |

*Trademarks of System General Corporation, used under license by Fairchild Semiconductor.

DISCLAIMER

FAIRCHILD SEMICONDUCTOR RESERVES THE RIGHT TO MAKE CHANGES WITHOUT FURTHER NOTICE TO ANY PRODUCTS HEREIN TO IMPROVE RELIABILITY, FUNCTION, OR DESIGN. FAIRCHILD DOES NOT ASSUME ANY LIABILITY ARISING OUT OF THE APPLICATION OR USE OF ANY PRODUCT OR CIRCUIT DESCRIBED HEREIN; NEITHER DOES IT CONVEY ANY LICENSE UNDER ITS PATENT RIGHTS, NOR THE RIGHTS OF OTHERS. THESE SPECIFICATIONS DO NOT EXPAND THE TERMS OF FAIRCHILD'S WORLDWIDE TERMS AND CONDITIONS, SPECIFICALLY THE WARRANTY THEREIN, WHICH COVERS THESE PRODUCTS.

LIFE SUPPORT POLICY

FAIRCHILD'S PRODUCTS ARE NOT AUTHORIZED FOR USE AS CRITICAL COMPONENTS IN LIFE SUPPORT DEVICES OR SYSTEMS WITHOUT THE EXPRESS WRITTEN APPROVAL OF FAIRCHILD SEMICONDUCTOR CORPORATION.

As used herein:

- Life support devices or systems are devices or systems which, (a) are intended for surgical implant into the body or (b) support or sustain life, and (c) whose failure to perform when properly used in accordance with instructions for use provided in the labeling, can be reasonably expected to result in a significant injury of the user.
- A critical component in any component of a life support, device, or system whose failure to perform can be reasonably expected to cause the failure of the life support device or system, or to affect its safety or effectiveness.

ANTI-COUNTERFEITING POLICY

Fairchild Semiconductor Corporation's Anti-Counterfeiting Policy. Fairchild's Anti-Counterfeiting Policy is also stated on our external website, www.Fairchildsemi.com, under Sales Support.

Counterfeiting of semiconductor parts is a growing problem in the industry. All manufactures of semiconductor products are experiencing counterfeiting of their parts. Customers who inadvertently purchase counterfeit parts experience many problems such as loss of brand reputation, substandard performance, failed application, and increased cost of production and manufacturing delays. Fairchild is taking strong measures to protect ourselves and our customers from the proliferation of counterfeit parts. Fairchild strongly encourages customers to purchase Fairchild parts either directly from Fairchild or from Authorized Fairchild Distributors who are listed by country on our web page cited above. Products customers buy either from Fairchild directly or from Authorized Fairchild Distributors are genuine parts, have full traceability, meet Fairchild's quality standards for handling and storage and provide access to Fairchild's full range of up-to-date technical and product information. Fairchild and our Authorized Distributors will stand behind all warranties and will appropriately address and warranty issues that may arise. Fairchild will not provide any warranty coverage or other assistance for parts bought from Unauthorized Sources. Fairchild is committed to combat this global problem and encourage our customers to do their part in stopping this practice by buying direct or from authorized distributors.

PRODUCT STATUS DEFINITIONS

Definition of Terms

Datasheet Identification	Product Status	Definition
Advance Information	Formative / In Design	Datasheet contains the design specifications for product development. Specifications may change in any manner without notice.
Preliminary	First Production	Datasheet contains preliminary data; supplementary data will be published at a later date. Fairchild Semiconductor reserves the right to make changes at any time without notice to improve design.
No Identification Needed	Full Production	Datasheet contains final specifications. Fairchild Semiconductor reserves the right to make changes at any time without notice to improve the design.
Obsolete	Not In Production	Datasheet contains specifications on a product that is discontinued by Fairchild Semiconductor. The datasheet is for reference information only.

Rev. I40