

isc Silicon PNP Power Transistor

BD636

DESCRIPTION

- DC Current Gain -  
:  $h_{FE} = 40(\text{Min.}) @ I_C = -25\text{mA}$
- Collector-Emitter Breakdown Voltage-  
:  $V_{(BR)CEO} = -60\text{V}(\text{Min.})$
- Complement to Type BD635

APPLICATIONS

- Designed for amplifier and switching applications.

ABSOLUTE MAXIMUM RATINGS( $T_a=25^\circ\text{C}$ )

SYMBOL	PARAMETER	VALUE	UNIT
$V_{CBO}$	Collector-Base Voltage	-60	V
$V_{CEO}$	Collector-Emitter Voltage	-60	V
$V_{EBO}$	Emitter-Base Voltage	-5	V
$I_C$	Collector Current-Continuous	-2	A
$I_{CM}$	Collector Current-Peak	-5	A
$I_B$	Base Current-Continuous	-0.3	A
$P_C$	Collector Power Dissipation @ $T_a=25^\circ\text{C}$	2	W
	Collector Power Dissipation @ $T_C=25^\circ\text{C}$	30	
$T_J$	Junction Temperature	150	$^\circ\text{C}$
$T_{stg}$	Storage Temperature Range	-55~150	$^\circ\text{C}$

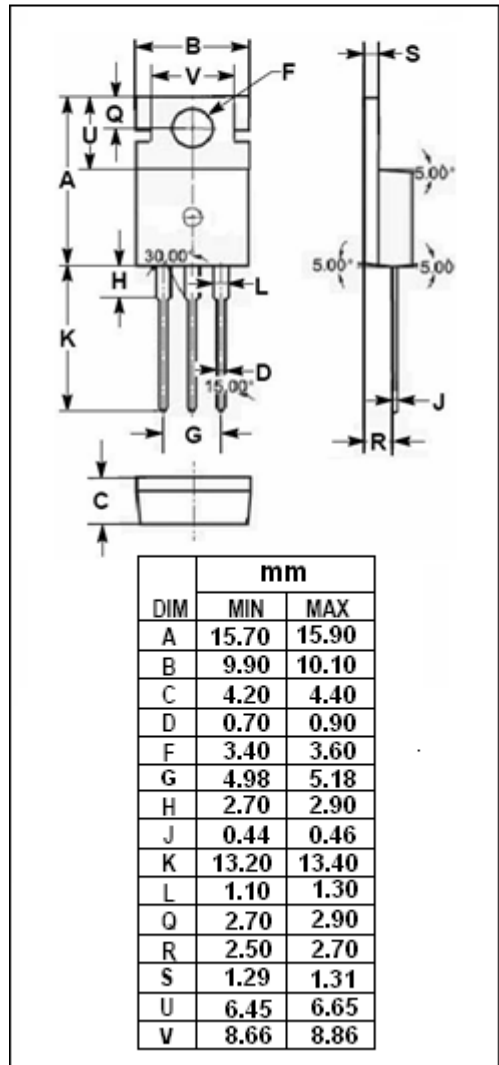
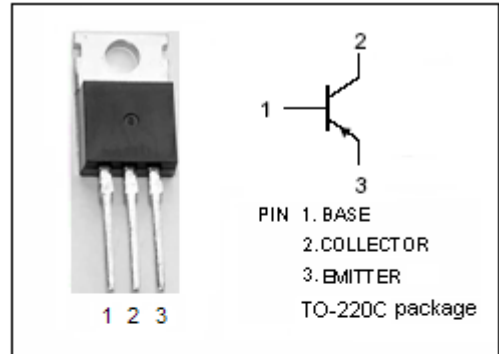

**isc Silicon PNP Power Transistor****BD636****ELECTRICAL CHARACTERISTICS** $T_C=25^{\circ}\text{C}$  unless otherwise specified

SYMBOL	PARAMETER	CONDITIONS	MIN	MAX	UNIT
$V_{(BR)CEO}$	Collector-Emitter Breakdown Voltage	$I_C = -30\text{mA}; I_B = 0$	-60		V
$V_{(BR)CBO}$	Collector-Base Breakdown Voltage	$I_C = -0.1\text{mA}; I_E = 0$	-60		V
$V_{(BR)EBO}$	Emitter-Base Breakdown Voltage	$I_E = -1\text{mA}; I_C = 0$	-5		V
$V_{CE(sat)}$	Collector-Emitter Saturation Voltage	$I_C = -1\text{A}; I_B = -0.1\text{A}$		-0.6	V
$V_{BE(on)}$	Base-Emitter On Voltage	$I_C = -1\text{A}; V_{CE} = -2\text{V}$		-1.3	V
$I_{CES}$	Collector Cutoff Current	$V_{CE} = -60\text{V}; V_{BE} = 0$		-0.2	mA
$h_{FE-1}$	DC Current Gain	$I_C = -25\text{mA}; V_{CE} = -2\text{V}$	40		
$h_{FE-2}$	DC Current Gain	$I_C = -1\text{A}; V_{CE} = -2\text{V}$	25		