

Bandpass Filter 252057B



1. Features

- IF bandpass filter
- Low-Loss Filter
- Single-ended operation
- Ceramic Surface Mount Device(SMD) Package
- Maximum Storage Temperature Range : -40℃ ~ 85℃
- Electrostatics Sensitive Device (ESD)

2. Package Dimension

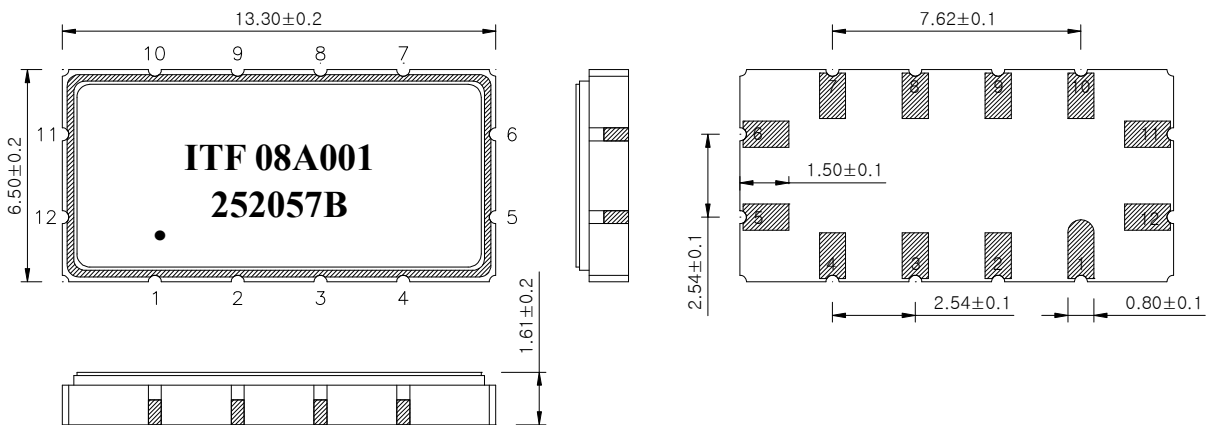

Package : S1365

Dimensions shown are nominal in millimeters

Body : Al₂O₃

Lid : Kovar, Ni Plated

Termination : Au plating 0.3 ~ 1.0um, over a 1.27 ~ 8.89um Ni Plating

Pin Configuration	
11	Input
5	Output
6, 12	Ground
Other	Case ground

	ITF Co., Ltd. 102-901, Bucheon Technopark 364, Samjeong-Dong, Ojeong-Gu, Bucheon-City, Gyeonggi-Do, Korea 421-809	Part No.	252057B	
		Rev. Date	2008-10-05	
		Rev.	NJ8016-CS02	1/5

Bandpass Filter 252057B



3. Specifications

F_o = 109.5 MHz

Terminating source impedance : 50Ω and matching network

Terminating load impedance : 50Ω and matching network

Operating temperature range : 0°C ~ +70°C		Minimum	Typical	Maximum
Center Frequency (F _c)	MHz	-	109.5	-
Insertion Loss	dB	-	12.0	15.0
1dB Bandwidth	MHz	19.0	19.7	-
3dB Bandwidth	MHz	-	20.64	-
10dB Bandwidth	MHz	-	22.1	22.3
20dB Bandwidth	MHz	-	23.1	-
30dB Bandwidth	MHz	-	23.7	-
40dB Bandwidth	MHz	-	24.1	25.0
Amplitude Ripple (F _o +/- 9.22 MHz)	dB	-	0.65	1.0
Group Delay Variation (F _o +/- 9.22 MHz)	nsec	-	55	80
Absolute Delay	usec	-	0.98	-
Ultimate Rejection	dB	40	45	-
Temperature Coefficient of Frequency (TCF)	ppm/°C	-	- 86	-

Room temperature : + 25 °C		Minimum	Typical	Maximum
Insertion Loss	dB	-	12.0	14.5
Amplitude Ripple (F _o +/- 9.57 MHz)	dB	-	0.65	1.0
Group Delay Variation (F _o +/- 9.57 MHz)	nsec	-	55	80
Relative Attenuation C.F – 15.8 MHz	dB	57	62	-

 Integrated Technology Future	ITF Co., Ltd. 102-901, Bucheon Technopark 364, Samjeong-Dong, Ojeong-Gu, Bucheon-City, Gyeonggi-Do, Korea 421-809	Part No.	252057B	
		Rev. Date	2008-10-05	
		Rev.	NJ8016-CS02	2/5

Bandpass Filter 252057B



Notes :

- 1) All specifications are based on the matching schematic shown below
- 2) All specifications are measured by Agilent Network analyzer and full 2 port calibration
- 3) Electrical margin has been built into the design to account for the variations due to temperature drift and manufacturing tolerances
- 4) All attenuation measurements are measured relative to insertion loss

4. Matching Schematic

(Actual matching values may vary due to PCB layout and parasitics)

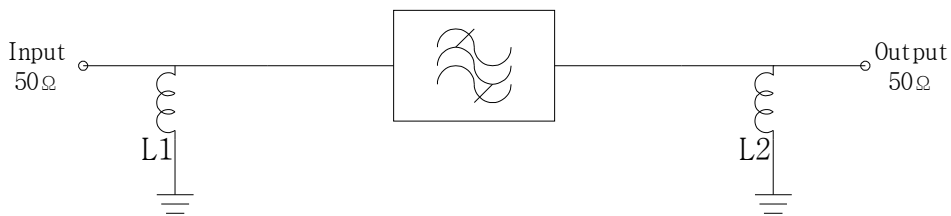

L1 = 27 nH, L2 = 33 nH

5. Marking Configuration

ITF¹⁾ 08A001²⁾

252057B³⁾

●⁴⁾

- 1) Manufacturer name
- 2) Lot Number
- 3) Part Number
- 4) Pad Number 1 Index

	ITF Co., Ltd. 102-901, Bucheon Technopark 364, Samjeong-Dong, Ojeong-Gu, Bucheon-City, Gyeonggi-Do, Korea 421-809	Part No.	252057B	
		Rev. Date	2008-10-05	
		Rev.	NJ8016-CS02	3/5

Bandpass Filter 252057B



6. Typical Performance (at +25°C)

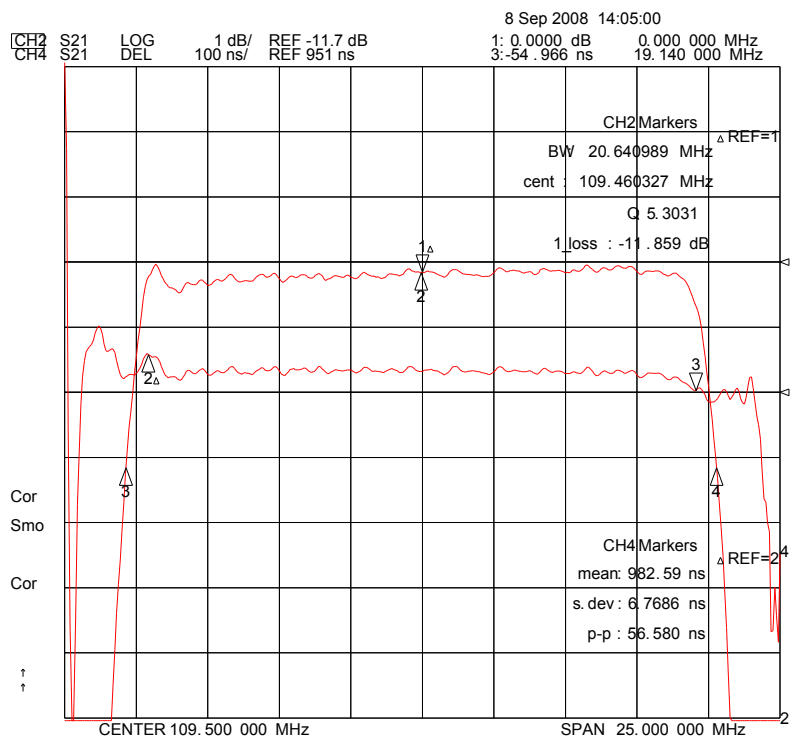
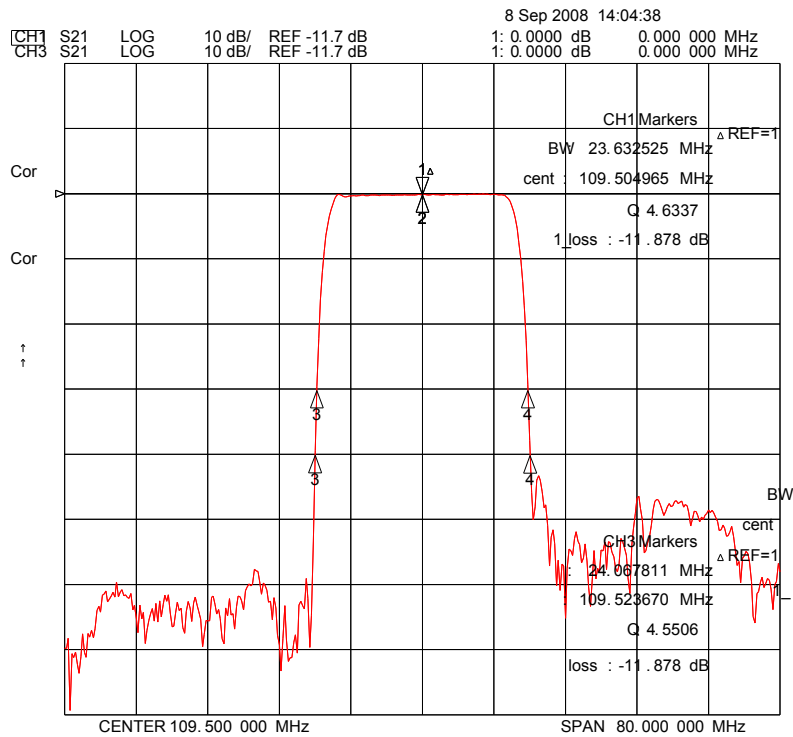

	ITF Co., Ltd. 102-901, Bucheon Technopark 364, Samjeong-Dong, Ojeong-Gu, Bucheon-City, Gyeonggi-Do, Korea 421-809	Part No.	252057B	
		Rev. Date	2008-10-05	
		Rev.	NJ8016-CS02	4/5

Bandpass Filter 252057B

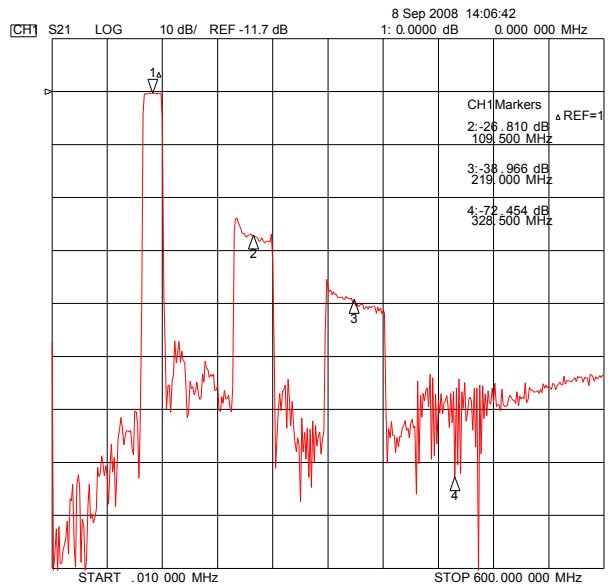
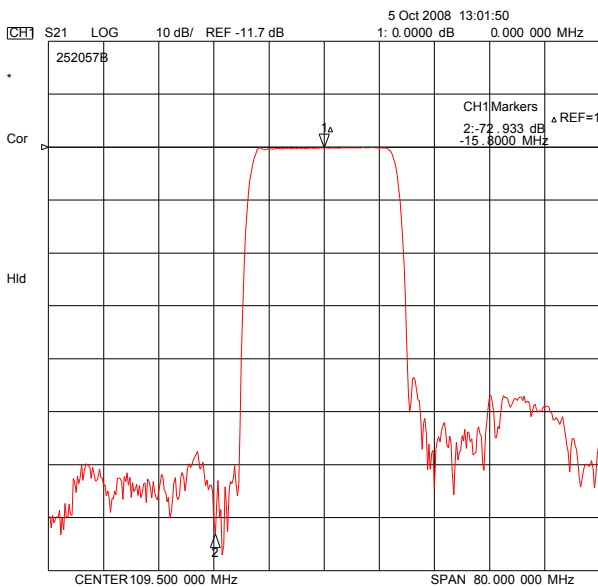
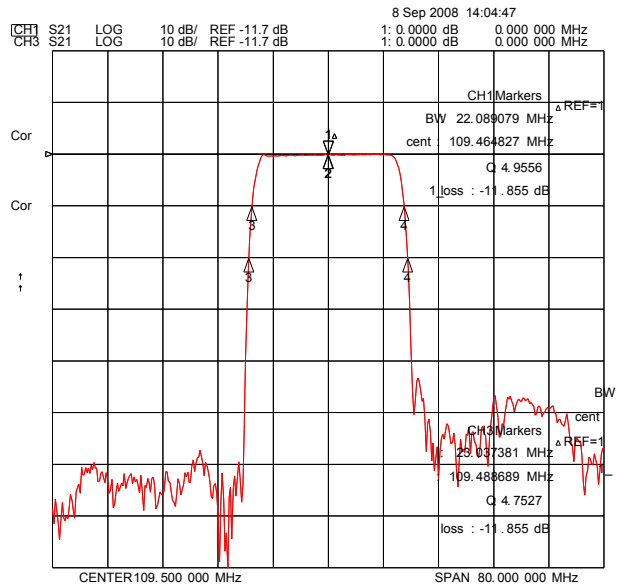
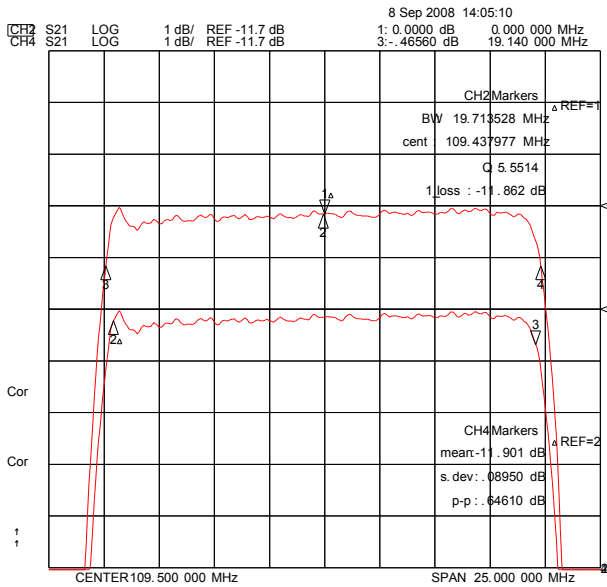

ITF Co., Ltd.
 102-901, Bucheon Technopark 364,
 Samjeong-Dong, Ojeong-Gu, Bucheon-City,
 Gyeonggi-Do, Korea 421-809

Part No.	252057B	
Rev. Date	2008-10-05	
Rev.	NJ8016-CS02	5/5