

Polar™ Power MOSFET

HiPerFET™

IXFB40N110P

N-Channel Enhancement Mode
Avalanche Rated
Fast Intrinsic Diode

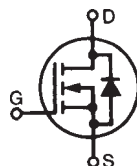

$V_{DSS} = 1100V$
 $I_{D25} = 40A$
 $R_{DS(on)} \leq 260m\Omega$
 $t_{rr} \leq 300ns$

PLUS264™ (IXFB)

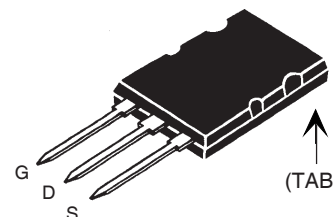

G = Gate D = Drain
S = Source TAB = Drain

Symbol	Test Conditions	Maximum Ratings	
V_{DSS}	$T_J = 25^\circ C$ to $150^\circ C$	1100	V
V_{DGR}	$T_J = 25^\circ C$ to $150^\circ C$, $R_{GS} = 1M\Omega$	1100	V
V_{GSS}	Continuous	± 30	V
V_{GSM}	Transient	± 40	V
I_{D25}	$T_C = 25^\circ C$	40	A
I_{DM}	$T_C = 25^\circ C$, pulse width limited by T_{JM}	100	A
I_{AR}	$T_C = 25^\circ C$	20	A
E_{AS}	$T_C = 25^\circ C$	2	J
dV/dt	$I_S \leq I_{DM}$, $V_{DD} \leq V_{DSS}$, $T_J \leq 150^\circ C$	15	V/ns
P_D	$T_C = 25^\circ C$	1250	W
T_J		-55 ... +150	$^\circ C$
T_{JM}		150	$^\circ C$
T_{stg}		-55 ... +150	$^\circ C$
T_L	1.6mm (0.062 in.) from case for 10s	300	$^\circ C$
T_{SOLD}	Plastic body for 10s	260	$^\circ C$
F_C	Mounting force	30..120/6.7..27	N/lb.
Weight		10	g

Features

- Fast recovery diode
- Unclamped Inductive Switching (UIS) rated
- Low package inductance
 - easy to drive and to protect

Advantages

- Plus 264™ package for clip or spring mounting
- Space savings
- High power density

Applications:

- High Voltage Switched-mode and resonant-mode power supplies
- High Voltage Pulse Power Applications
- High Voltage Discharge circuits in Lasers Pulsers, Spark Igniters, RF Generators
- High Voltage DC-DC converters
- High Voltage DC-AC inverters

Symbol	Test Conditions	Characteristic Values		
		Min.	Typ.	Max.
BV_{DSS}	$V_{GS} = 0V$, $I_D = 3mA$	1100		V
$V_{GS(th)}$	$V_{DS} = V_{GS}$, $I_D = 1mA$	3.5		6.5 V
I_{GSS}	$V_{GS} = \pm 30V$, $V_{DS} = 0V$			± 200 nA
I_{DSS}	$V_{DS} = V_{DSS}$ $V_{GS} = 0V$			50 μA 3 mA
$R_{DS(on)}$	$V_{GS} = 10V$, $I_D = 0.5 \cdot I_{D25}$, Note 1			260 m Ω

Symbol	Test Conditions	Characteristic Values		
		Min.	Typ.	Max.
g_{fs}	$V_{DS} = 20V, I_D = 0.5 \cdot I_{D25}$, Note 1	20	32	S
C_{iss}	$V_{GS} = 0V, V_{DS} = 25V, f = 1MHz$		19	nF
C_{oss}			1070	pF
C_{rss}			46	pF
R_{GI}	Gate Input Resistance		1.65	Ω
$t_{d(on)}$	Resistive Switching Times $V_{GS} = 10V, V_{DS} = 0.5 \cdot V_{DSS}, I_D = 0.5 \cdot I_{D25}$ $R_G = 1\Omega$ (External)		53	ns
t_r			55	ns
$t_{d(off)}$			110	ns
t_f			54	ns
$Q_{g(on)}$	$V_{GS} = 10V, V_{DS} = 0.5 \cdot V_{DSS}, I_D = 0.5 \cdot I_{D25}$		310	nC
Q_{gs}			95	nC
Q_{gd}			142	nC
R_{thJC}			0.10	$^{\circ}C/W$
R_{thCS}		0.13		$^{\circ}C/W$

Source-Drain Diode

Characteristic Values
($T_J = 25^{\circ}C$, unless otherwise specified)

Symbol	Test Conditions	Characteristic Values		
		Min.	Typ.	Max.
I_S	$V_{GS} = 0V$			40 A
I_{SM}	Repetitive, pulse width limited by T_{JM}			160 A
V_{SD}	$I_F = I_S, V_{GS} = 0V$, Note 1			1.5 V
t_{rr}	$I_F = 20A, -di/dt = 100A/\mu s$ $V_R = 100V, V_{GS} = 0V$			300 ns
Q_{RM}			2.2	μC
I_{RM}			16	A

Note 1: Pulse test, $t \leq 300\mu s$; duty cycle, $d \leq 2\%$.

PLUS264™ (IXFB) Outline

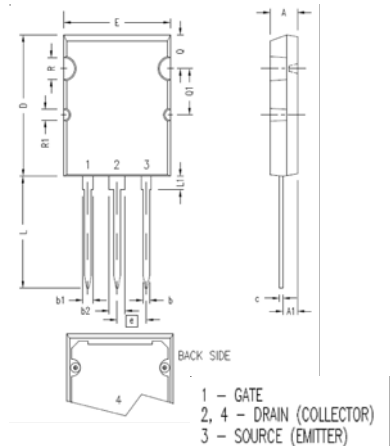

SYM	INCHES		MILLIMETERS	
	MIN	MAX	MIN	MAX
A	.185	.209	4.70	5.31
A1	.102	.118	2.59	3.00
b	.037	.055	0.94	1.40
b1	.087	.102	2.21	2.59
b2	.110	.126	2.79	3.20
c	.017	.029	0.43	0.74
D	1.007	1.047	25.58	26.59
E	.760	.799	19.30	20.29
e	.215 BSC		5.46 BSC	
L	.779	.842	19.79	21.39
L1	.087	.102	2.21	2.59
Q	.240	.256	6.10	6.50
Q1	.330	.346	8.38	8.79
ØR	.155	.187	3.94	4.75
ØR1	.085	.093	2.16	2.36

IXYS reserves the right to change limits, test conditions, and dimensions.

IXYS MOSFETs and IGBTs are covered by one or more of the following U.S. patents:	4,835,592	4,931,844	5,049,961	5,237,481	6,162,665	6,404,065 B1	6,683,344	6,727,585	7,005,734 B2	7,157,338B2
	4,850,072	5,017,508	5,063,307	5,381,025	6,259,123 B1	6,534,343	6,710,405 B2	6,759,692	7,063,975 B2	
	4,881,106	5,034,796	5,187,117	5,486,715	6,306,728 B1	6,583,505	6,710,463	6,771,478 B2	7,071,537	

Fig. 1. Output Characteristics @ 25°C

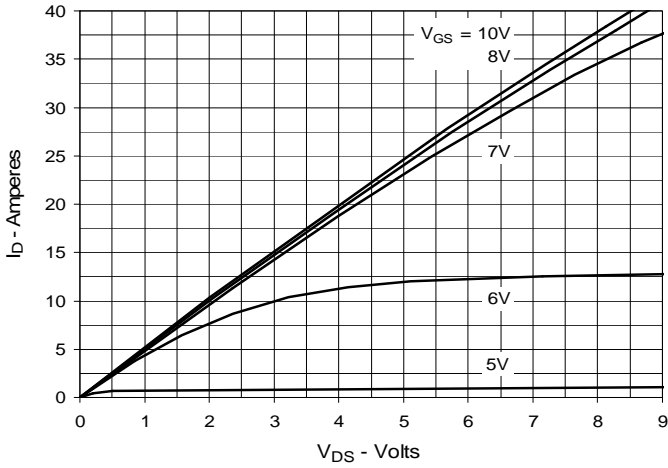

Fig. 2. Extended Output Characteristics @ 25°C

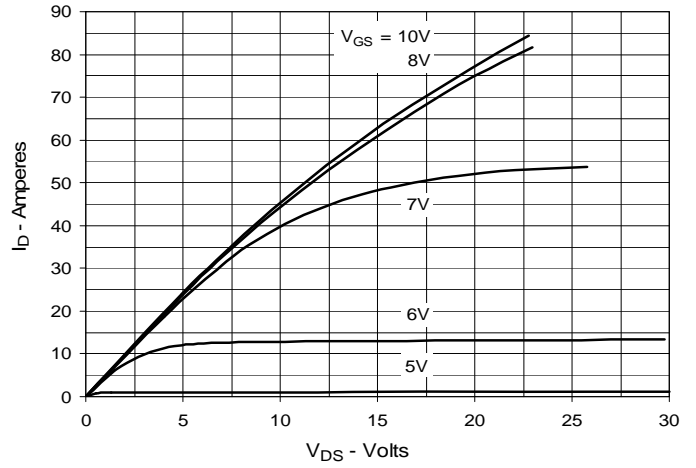

Fig. 3. Output Characteristics @ 125°C

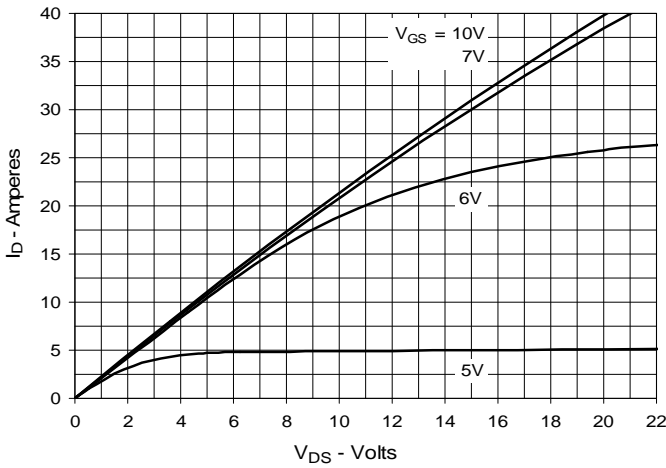

Fig. 4. $R_{DS(on)}$ Normalized to $I_D = 20A$ Value vs. Junction Temperature

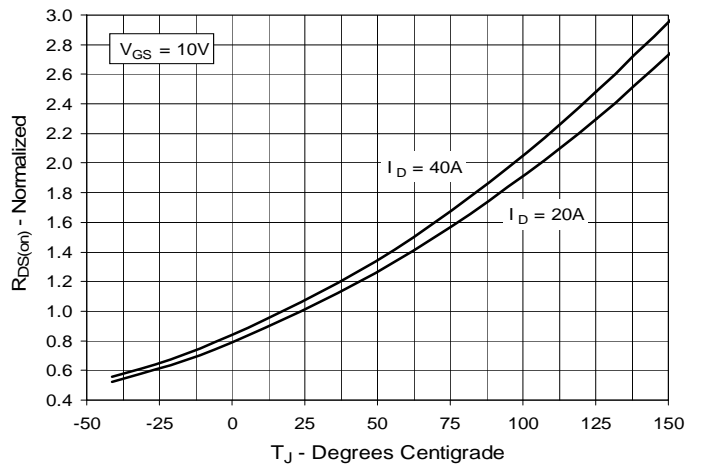

Fig. 5. $R_{DS(on)}$ Normalized to $I_D = 20A$ Value vs. Drain Current

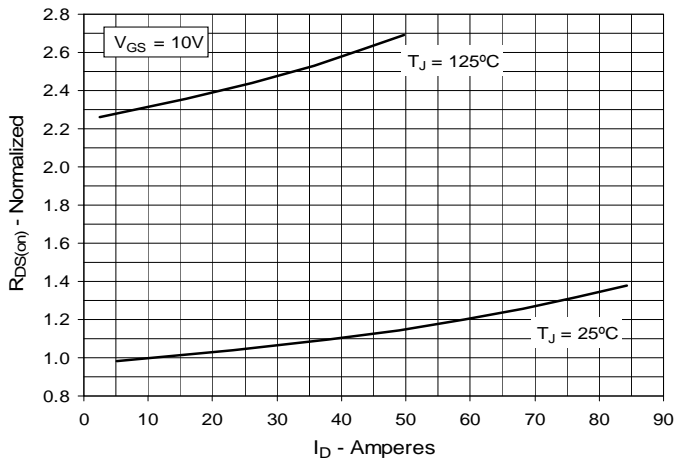

Fig. 6. Maximum Drain Current vs. Case Temperature

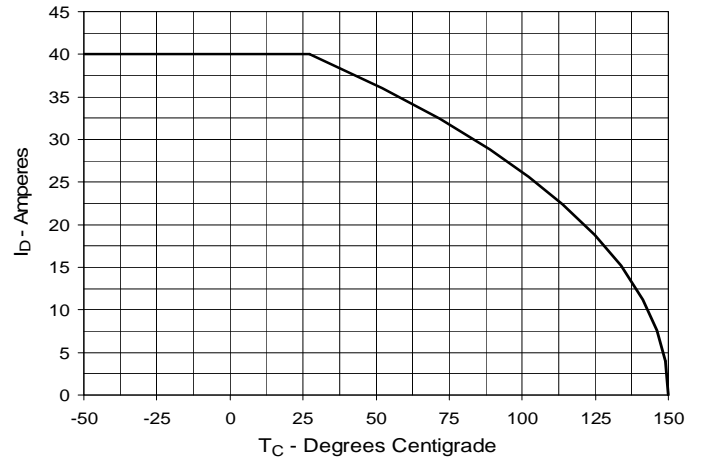
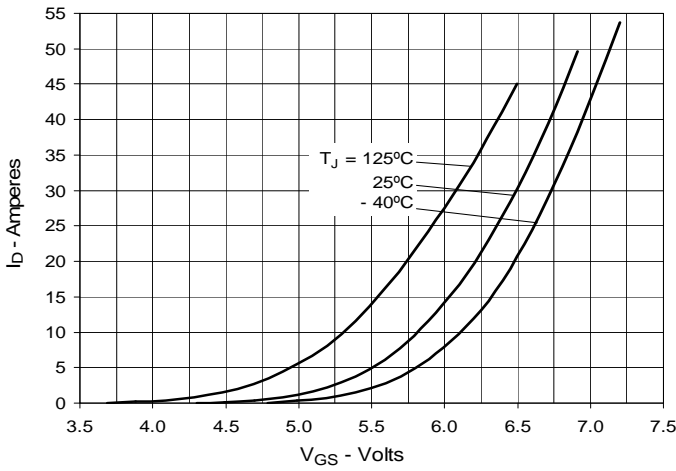
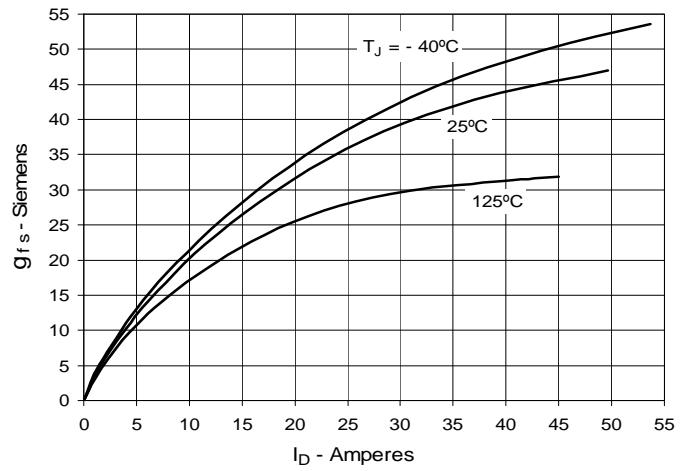
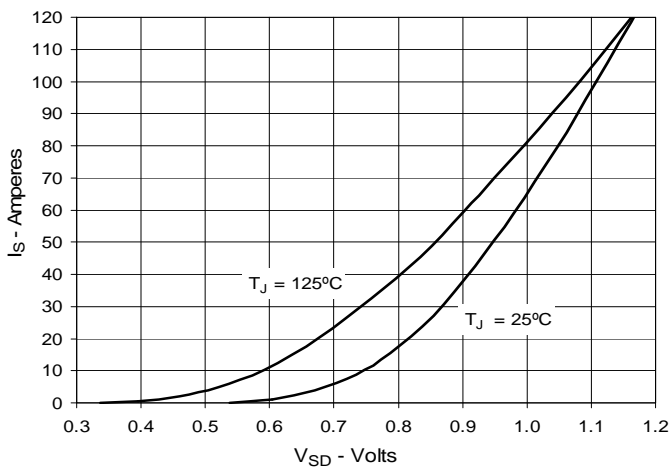
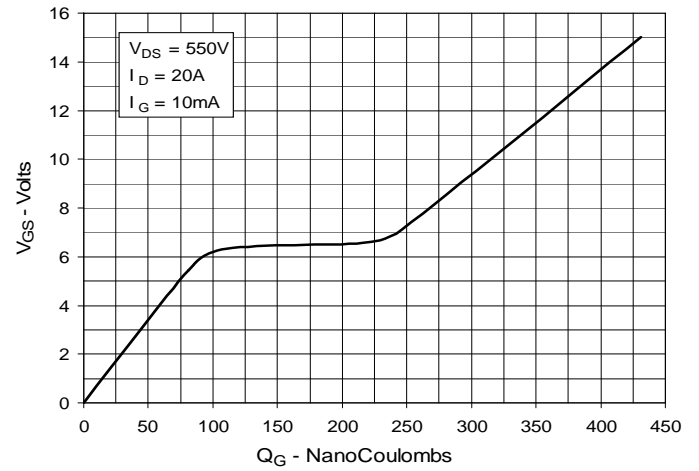
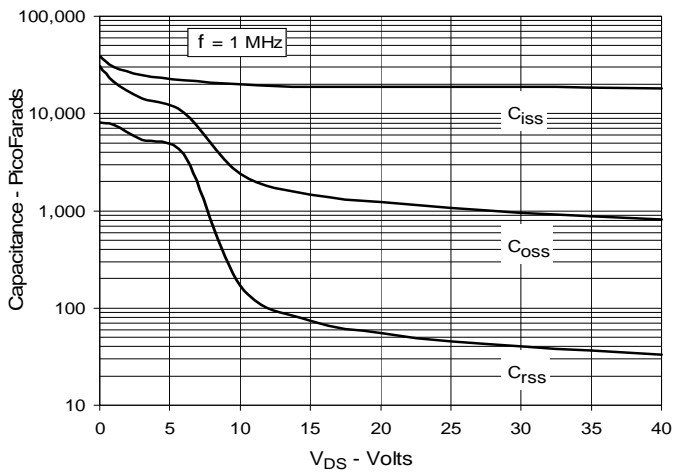
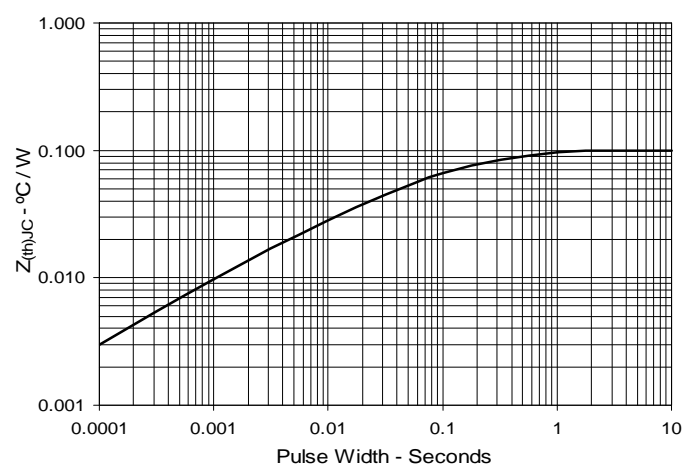

Fig. 7. Input Admittance

Fig. 8. Transconductance

Fig. 9. Forward Voltage Drop of Intrinsic Diode

Fig. 10. Gate Charge

Fig. 11. Capacitance

Fig. 12. Maximum Transient Thermal Impedance

IXYS reserves the right to change limits, test conditions, and dimensions.