

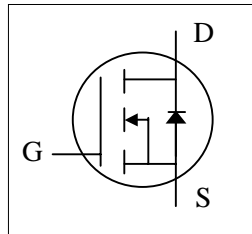

- ▼ Ease of Paralleling
- ▼ Fast Switching Characteristic
- ▼ Simple Drive Requirement



|              |               |
|--------------|---------------|
| $BV_{DSS}$   | 500V          |
| $R_{DS(ON)}$ | 0.85 $\Omega$ |
| $I_D$        | 8A            |

## Description

APEC MOSFET provide the power designer with the best combination of fast switching , lower on-resistance and reasonable

The TO-220CFM isolation package is widely preferred for commercial-industrial through hole applications.

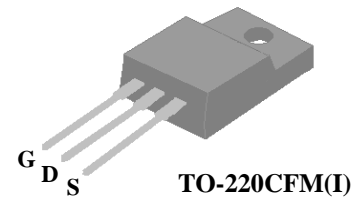

## Absolute Maximum Ratings

| Symbol                | Parameter                                  | Rating     | Units      |
|-----------------------|--|------------|------------|
| $V_{DS}$              | Drain-Source Voltage                       | 500        | V          |
| $V_{GS}$              | Gate-Source Voltage                        | $\pm 20$   | V          |
| $I_D@T_C=25^\circ C$  | Continuous Drain Current, $V_{GS}$ @ 10V   | 8          | A          |
| $I_D@T_C=100^\circ C$ | Continuous Drain Current, $V_{GS}$ @ 10V   | 5.1        | A          |
| $I_{DM}$              | Pulsed Drain Current <sup>1</sup>          | 32         | A          |
| $P_D@T_C=25^\circ C$  | Total Power Dissipation                    | 35         | W          |
| $E_{AS}$              | Single Pulse Avalanche Energy <sup>2</sup> | 320        | mJ         |
| $I_{AR}$              | Avalanche Current                          | 8          | A          |
| $T_{STG}$             | Storage Temperature Range                  | -55 to 150 | $^\circ C$ |
| $T_J$                 | Operating Junction Temperature Range       | -55 to 150 | $^\circ C$ |

## Thermal Data

| Symbol | Parameter                                    | Value | Unit         |
|--------|--|-------|--------------|
| Rthj-c | Maximum Thermal Resistance, Junction-case    | 3.6   | $^\circ C/W$ |
| Rthj-a | Maximum Thermal Resistance, Junction-ambient | 65    | $^\circ C/W$ |



**Electrical Characteristics @ $T_j=25^{\circ}\text{C}$ (unless otherwise specified)**

| Symbol       | Parameter  | Test Conditions               | Min. | Typ. | Max.      | Units    |
|--------------|--|-------------------------------|------|------|-----------|----------|
| $BV_{DSS}$   | Drain-Source Breakdown Voltage                             | $V_{GS}=0V, I_D=1mA$          | 500  | -    | -         | V        |
| $R_{DS(ON)}$ | Static Drain-Source On-Resistance <sup>3</sup>             | $V_{GS}=10V, I_D=4.8A$        | -    | -    | 0.85      | $\Omega$ |
| $V_{GS(th)}$ | Gate Threshold Voltage                                     | $V_{DS}=V_{GS}, I_D=250\mu A$ | 2    | -    | 4         | V        |
| $g_{fs}$     | Forward Transconductance                                   | $V_{DS}=10V, I_D=4.8A$        | -    | 4.2  | -         | S        |
| $I_{DSS}$    | Drain-Source Leakage Current ( $T_j=25^{\circ}\text{C}$ )  | $V_{DS}=500V, V_{GS}=0V$      | -    | -    | 25        | $\mu A$  |
|              | Drain-Source Leakage Current ( $T_j=125^{\circ}\text{C}$ ) | $V_{DS}=400V, V_{GS}=0V$      | -    | -    | 250       | $\mu A$  |
| $I_{GSS}$    | Gate-Source Leakage  | $V_{GS}=\pm 20V$              | -    | -    | $\pm 100$ | nA       |
| $Q_g$        | Total Gate Charge <sup>3</sup>                             | $I_D=8A$                      | -    | 45   | 72        | nC       |
| $Q_{gs}$     | Gate-Source Charge   | $V_{DS}=400V$                 | -    | 7    | -         | nC       |
| $Q_{gd}$     | Gate-Drain ("Miller") Charge                               | $V_{GS}=10V$                  | -    | 25   | -         | nC       |
| $t_{d(on)}$  | Turn-on Delay Time <sup>3</sup>                            | $V_{DD}=250V$                 | -    | 12   | -         | ns       |
| $t_r$        | Rise Time  | $I_D=8A$                      | -    | 31   | -         | ns       |
| $t_{d(off)}$ | Turn-off Delay Time  | $R_G=9.1\Omega, V_{GS}=10V$   | -    | 48   | -         | ns       |
| $t_f$        | Fall Time  | $R_D=31\Omega$                | -    | 33   | -         | ns       |
| $C_{iss}$    | Input Capacitance  | $V_{GS}=0V$                   | -    | 1250 | 2000      | pF       |
| $C_{oss}$    | Output Capacitance   | $V_{DS}=25V$                  | -    | 270  | -         | pF       |
| $C_{rss}$    | Reverse Transfer Capacitance                               | $f=1.0MHz$                    | -    | 85   | -         | pF       |
| $R_g$        | Gate Resistance  | $f=1.0MHz$                    | -    | 1.6  | 2.4       | $\Omega$ |

**Source-Drain Diode**

| Symbol   | Parameter                          | Test Conditions                             | Min. | Typ. | Max. | Units   |
|----------|------------------------------------|---|------|------|------|---------|
| $V_{SD}$ | Forward On Voltage <sup>3</sup>    | $T_j=25^{\circ}\text{C}, I_S=8A, V_{GS}=0V$ | -    | -    | 1.5  | V       |
| $t_{rr}$ | Reverse Recovery Time <sup>3</sup> | $I_S=8A, V_{GS}=0V,$<br>$di/dt=100A/\mu s$  | -    | 515  | -    | ns      |
| $Q_{rr}$ | Reverse Recovery Charge            |   | -    | 8.6  | -    | $\mu C$ |

**Notes:**

- 1.Pulse width limited by Max. junction temperature.
- 2.Starting  $T_j=25^{\circ}\text{C}$  ,  $V_{DD}=50V$  ,  $L=10mH$  ,  $R_G=25\Omega$
- 3.Pulse test

THIS PRODUCT IS AN ELECTROSTATIC SENSITIVE, PLEASE HANDLE WITH CAUTION.

THIS PRODUCT HAS BEEN QUALIFIED FOR CONSUMER MARKET. APPLICATIONS OR USES AS CRITERIAL COMPONENT IN LIFE SUPPORT DEVICE OR SYSTEM ARE NOT AUTHORIZED.

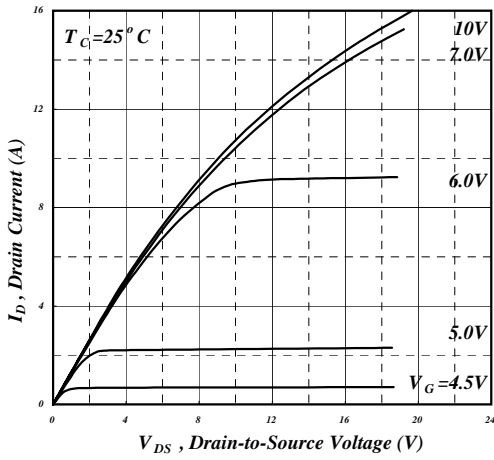

Fig 1. Typical Output Characteristics

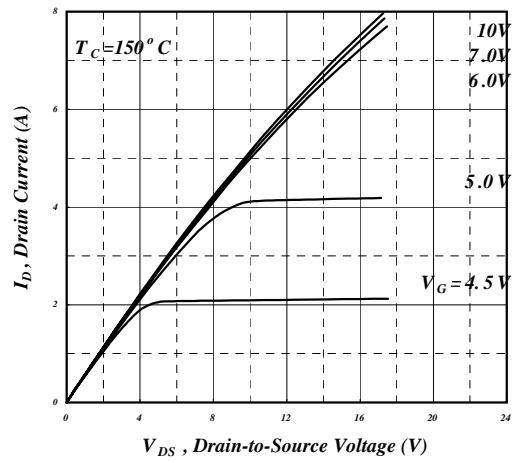

Fig 2. Typical Output Characteristics

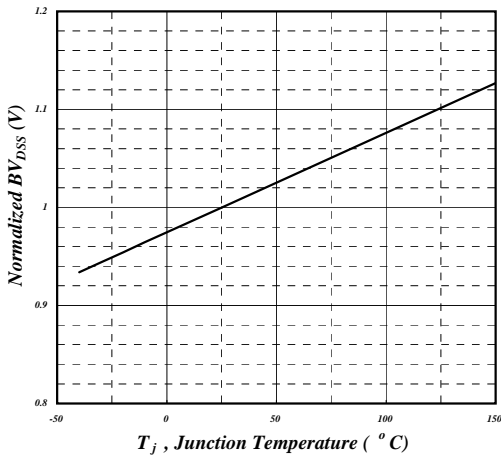

Fig 3. Normalized  $BV_{DSS}$  v.s. Junction Temperature

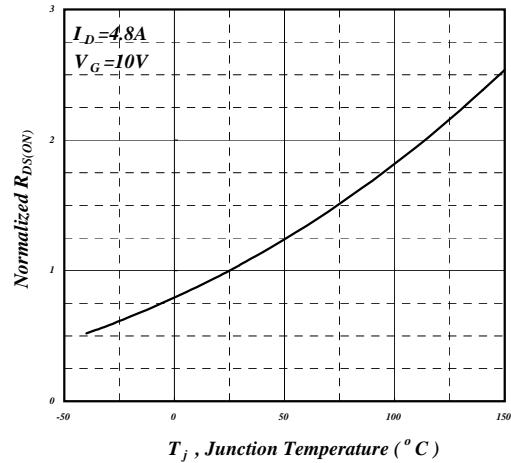

Fig 4. Normalized On-Resistance v.s. Junction Temperature

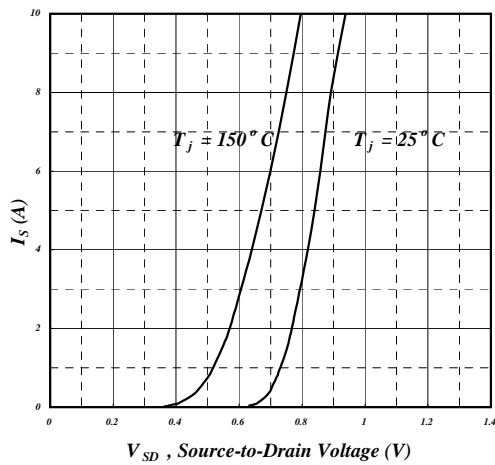

Fig 5. Forward Characteristic of Reverse Diode

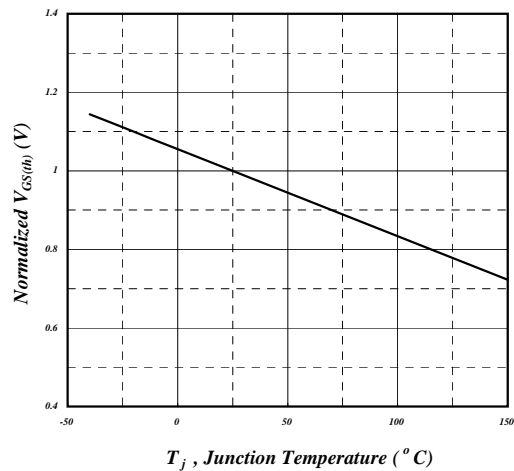

Fig 6. Gate Threshold Voltage v.s. Junction Temperature

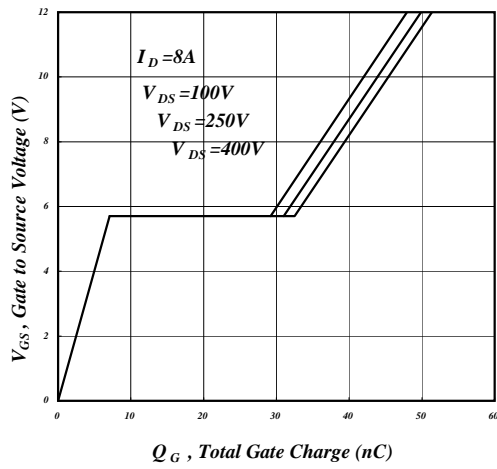

Fig 7. Gate Charge Characteristics

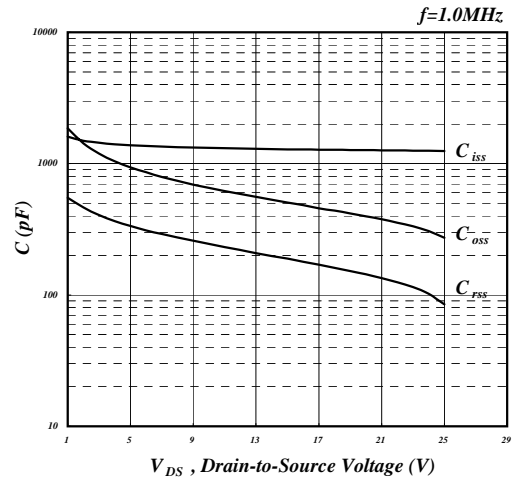

Fig 8. Typical Capacitance Characteristics

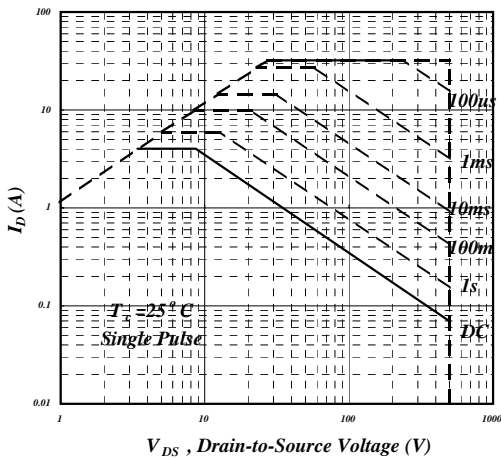

Fig 9. Maximum Safe Operating Area

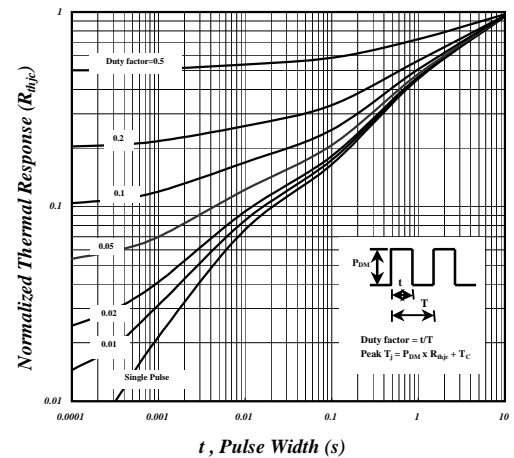

Fig 10. Effective Transient Thermal Impedance

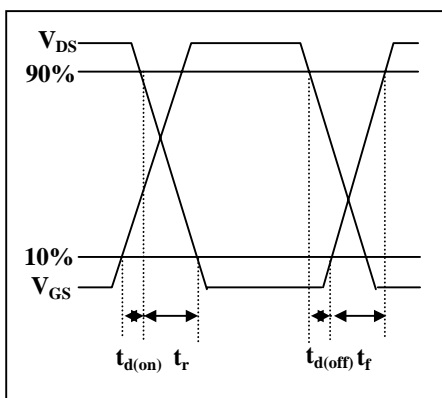

Fig 11. Switching Time Waveform

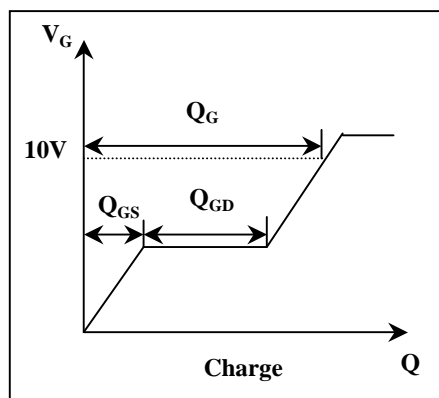
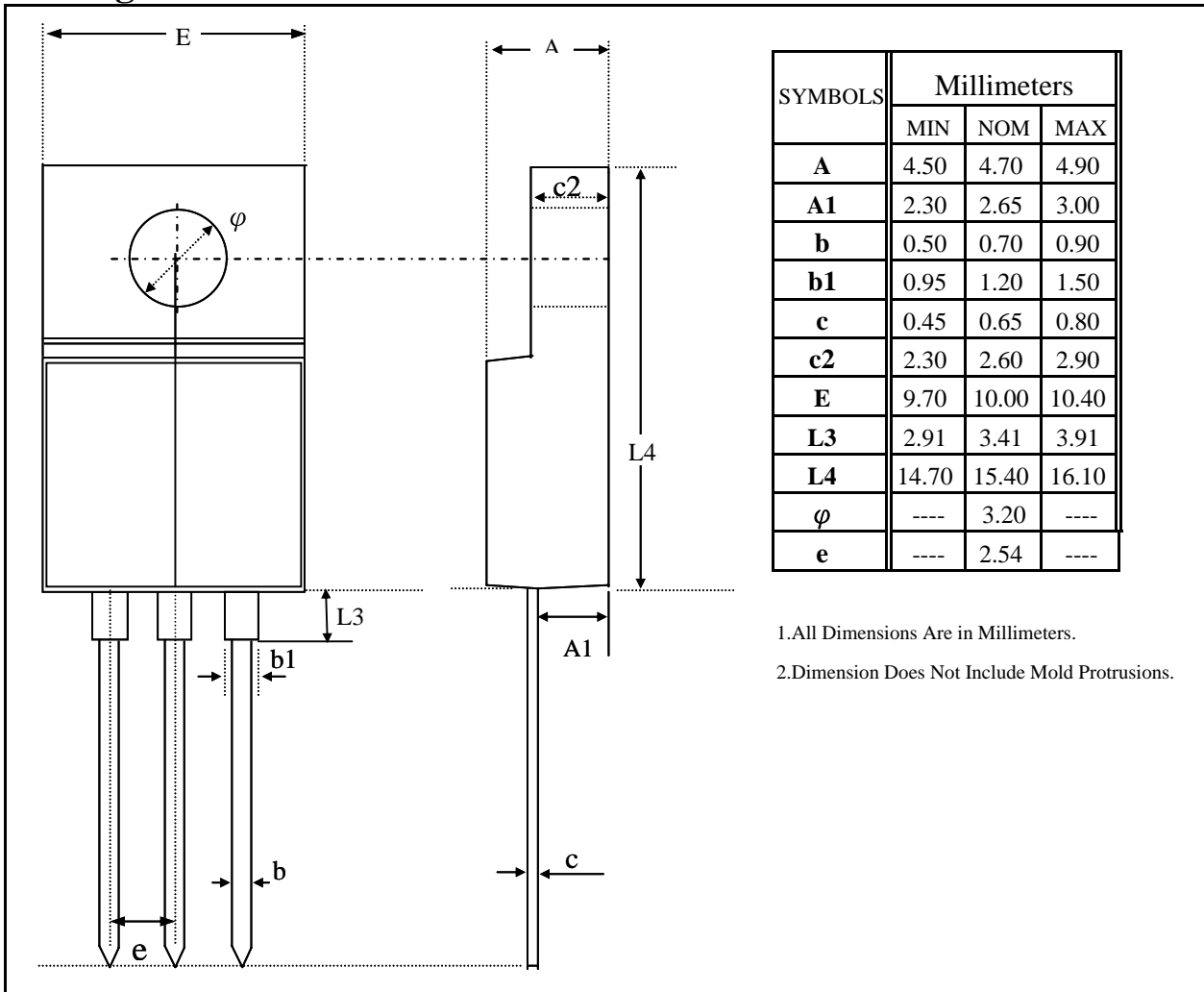

Fig 12. Gate Charge Waveform



### Package Outline : TO-220CFM



### Part Marking Information & Packing : TO-220CFM

