

Power Management Switch ICs for PCs and Digital Consumer Products

# 1ch Small Package High Side Switch ICs for USB Devices and Memory Cards



BD2240G, BD2241G

No.11029EAT24

## ●Description

BD2240G and BD2241G are low on-resistance N-channel MOSFET high-side power switches, optimized for Universal Serial Bus (USB) applications. BD2240G and BD2241G are equipped with the function of over-current detection, thermal shutdown, under-voltage lockout and soft-start.

## ●Features

- 1) Low On-Resistance (Typ. 110mΩ) N-channel MOSFET Built-in
- 2) Reverse Current Protection when Power Switch Off
- 3) Output Discharge Function
- 4) Over-Current Detection
- 5) Thermal Shutdown
- 6) Open-Drain Fault Flag Output
- 7) Under-Voltage Lockout
- 8) Soft-Start Circuit
- 9) Input Voltage Range: 2.7V ~ 5.5V
- 10) Control Input Logic Active-High (BD2240G), Active-Low (BD2241G)
- 11) SSOP5 Package

## ●Absolute Maximum Ratings (Ta=25°C)

Parameter	Symbol	Ratings	Unit
VIN supply voltage	VIN	-0.3 ~ 6.0	V
EN(/EN) input voltage	VEN(/EN)	-0.3 ~ 6.0	V
/OC voltage	V/OC	-0.3 ~ 6.0	V
/OC sink current	I/OC	5	mA
VOUT voltage	VOUT	-0.3 ~ 6.0	V
Storage temperature	TSTG	-55 ~ 150	°C
Power dissipation	Pd	675 <sup>*1</sup>	mW

\*1 Mounted on 70mm x 70mm x 1.6mm glass epoxy board. Reduce 5.4mW per 1°C above 25°C

\* This IC is not designed to be radiation-proof.

## ●Operating Conditions

Parameter	Symbol	Ratings			Unit
		Min.	Typ.	Max.	
VIN operating voltage	VIN	2.7	5.0	5.5	V
Operating temperature	TOPR	-40	-	85	°C

**●Electrical Characteristics** (VIN= 5V, Ta= 25°C, unless otherwise specified.)

DC Characteristics

Parameter	Symbol	Limits			Unit	Conditions
		Min.	Typ.	Max.		
Operating current	IDD	-	110	160	μA	VEN = 5V (BD2240G) V/EN = 0V (BD2241G) VOUT = open
Standby current	ISTB	-	0.01	5	μA	VEN = 0V (BD2240G) V/EN = 5V (BD2241G) VOUT = open
EN(/EN) input voltage	VENH(/ENH)	2.0	-	-	V	High input
	VENL(/ENL)	-	-	0.8	V	Low input
EN(/EN) input leakage	IEN(/EN)	-1	0.01	1	μA	VEN(/EN) = 0V or 5V
On-resistance	RON	-	110	155	mΩ	IOUT = 500mA
Reverse leak current	IREV	-	-	1.0	μA	VOUT = 5.0V, VIN = 0V
Over-current threshold	ITH	820	970	1120	mA	
Short circuit output current	ISC	500	650	850	mA	VOUT = 0V, RMS
Output discharge resistance	RDISC	30	60	120	Ω	IDISC = 1mA
/OC output low voltage	V/OC	-	-	0.4	V	I/OC = 0.5mA
UVLO threshold	VTUVH	2.1	2.3	2.5	V	VIN increasing
	VTUVL	2.0	2.2	2.4	V	VIN decreasing

AC Characteristics

Parameter	Symbol	Limits			Unit	Conditions
		Min.	Typ.	Max.		
Output rise time	TON1	-	1	6	ms	RL = 20Ω
Output turn-on time	TON2	-	1.5	10	ms	RL = 20Ω
Output fall time	TOFF1	-	1	20	μs	RL = 20Ω
Output turn-off time	TOFF2	-	3	40	μs	RL = 20Ω
/OC delay time	T/OC	10	15	20	ms	

●Measurement Circuit

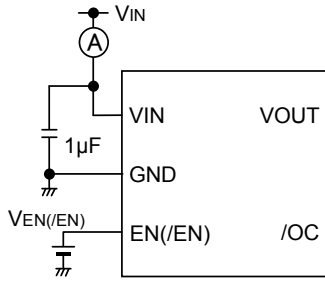

Operating current

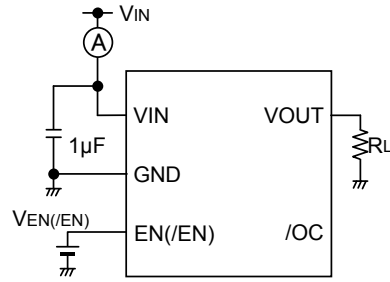

EN, /EN Input voltage, Output rise/fall time

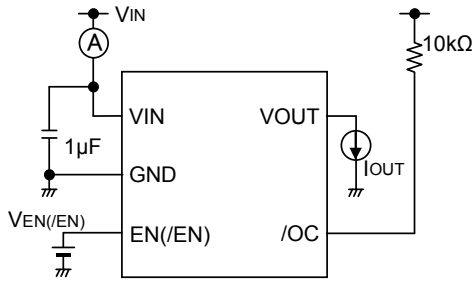

On-resistance, Over-current detection

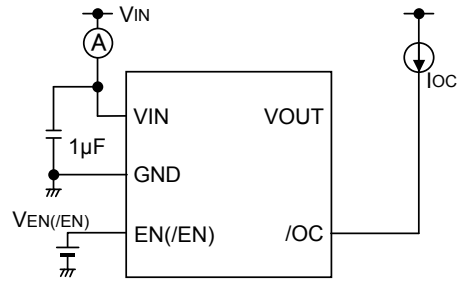

/OC Output low voltage

Fig.1 Measurement circuit

●Timing Diagram

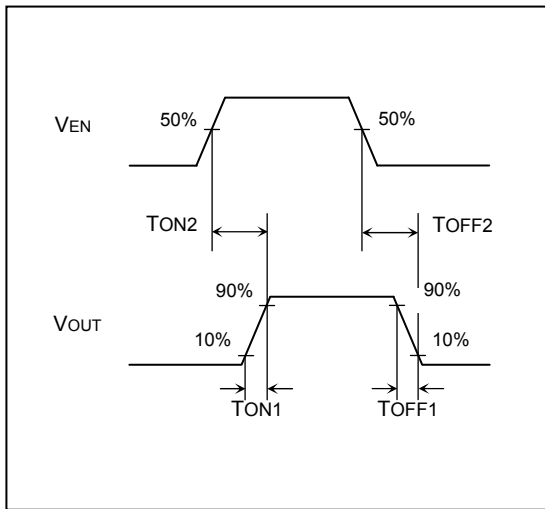

Fig.2 Output rise/fall time (BD2240G)

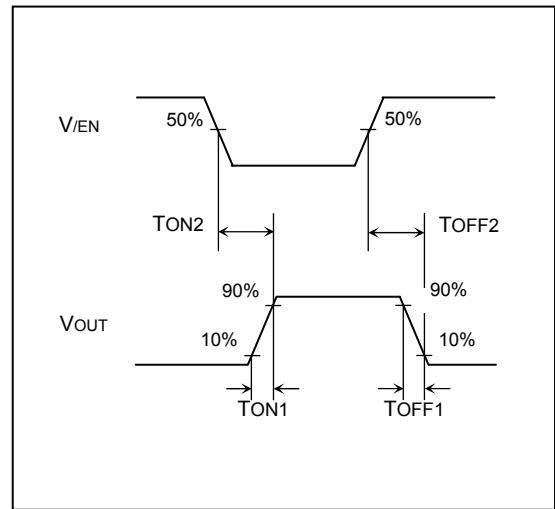

Fig.3 Output rise/fall time (BD2241G)

●Reference Data

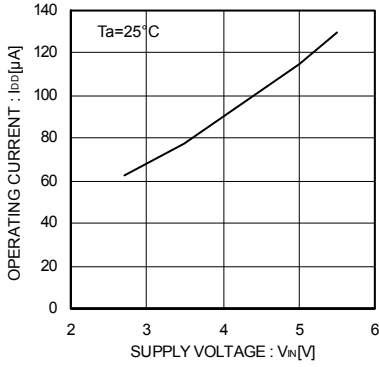

Fig.4 Operating current EN,/EN enable

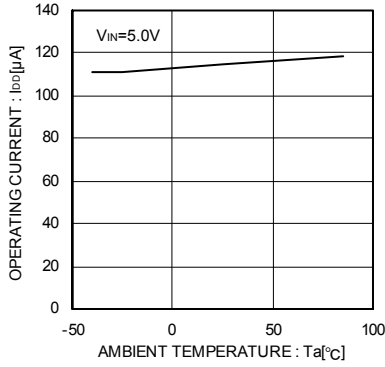

Fig.5 Operating current EN,/EN enable

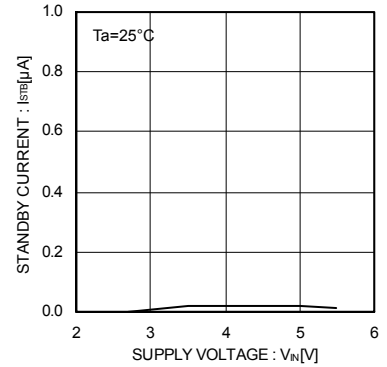

Fig.6 Standby current EN,/EN disable

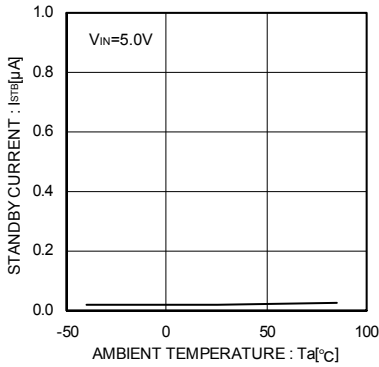

Fig.7 Standby current EN,/EN disable

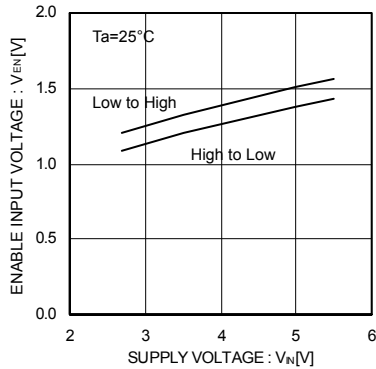

Fig.8 EN,/EN input voltage

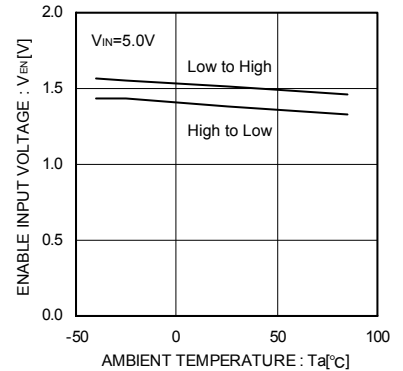

Fig.9 EN,/EN input voltage

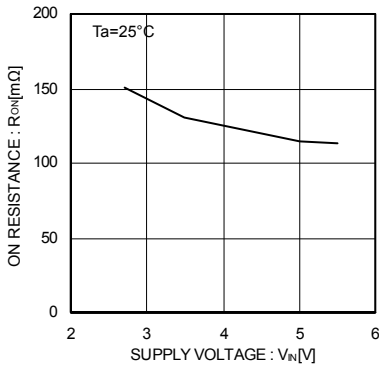

Fig.10 On-resistance

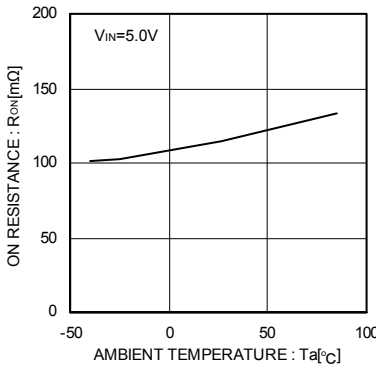

Fig.11 On-resistance

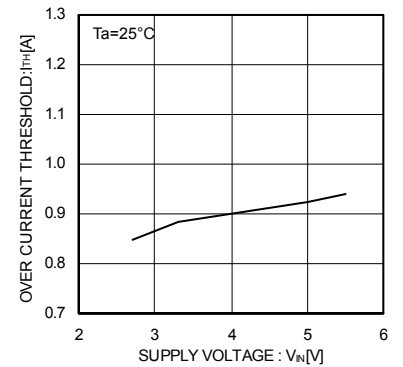

Fig.12 Over-current threshold

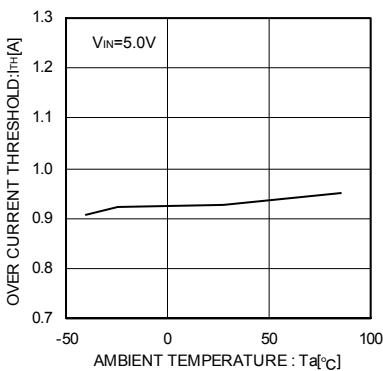

Fig.13 Over-current threshold

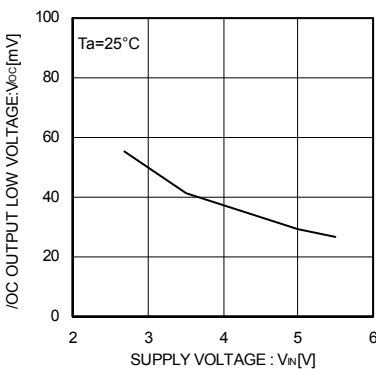

Fig.14 /OC output low voltage

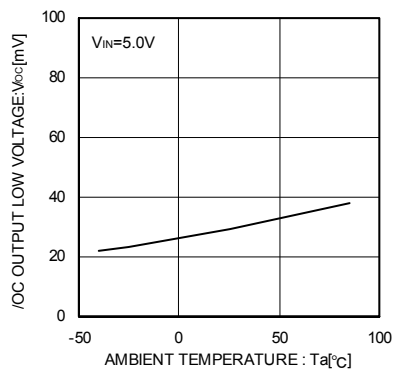

Fig.15 /OC output low voltage

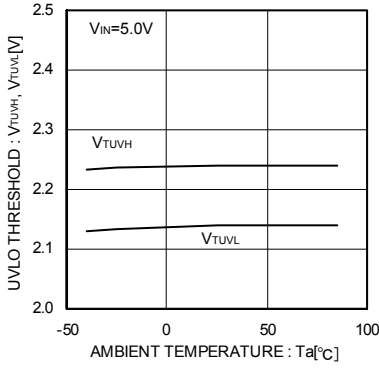

Fig.16 UVLO threshold

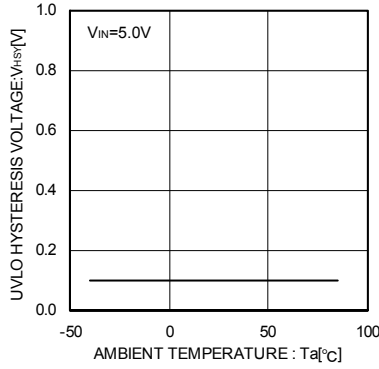

Fig.17 UVLO hysteresis voltage

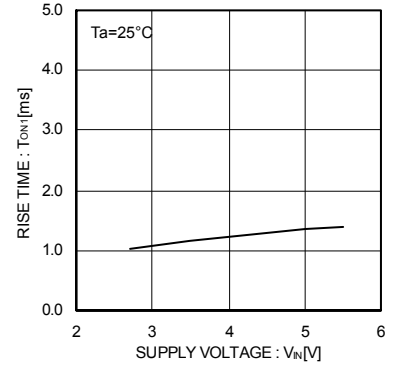

Fig.18 Output rise time

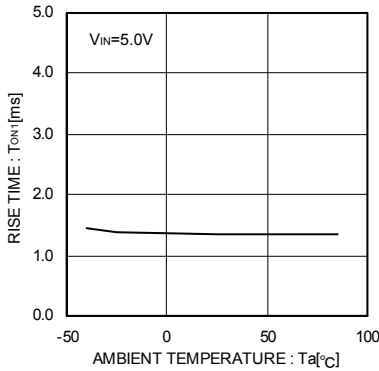

Fig.19 Output rise time

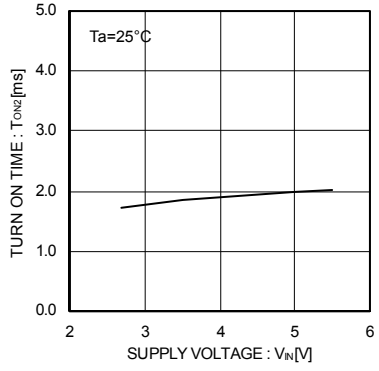

Fig.20 Output turn-on time

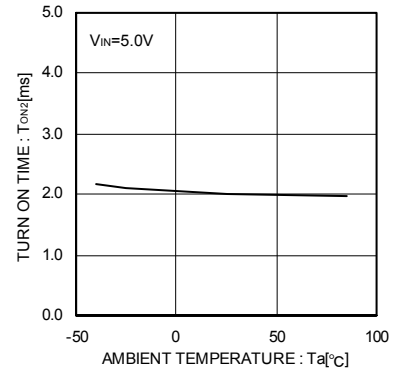

Fig.21 Output turn-on time

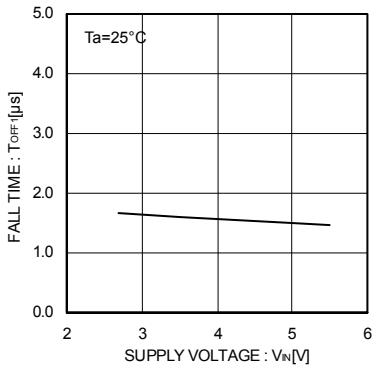

Fig.22 Output fall time

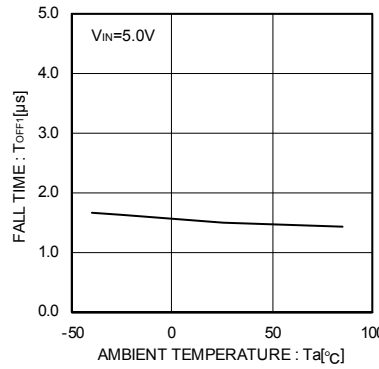

Fig.23 Output fall time

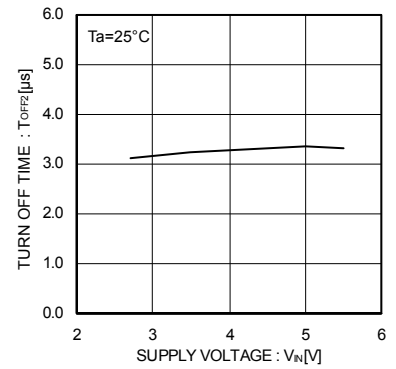

Fig.24 Output turn-off time

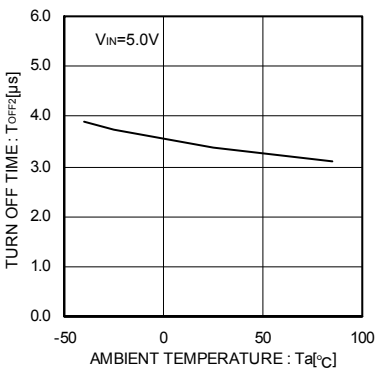

Fig.25 Output turn-off time

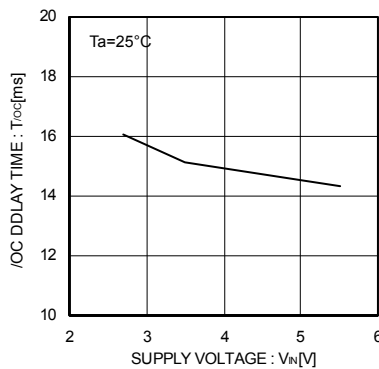

Fig.26 /OC delay time

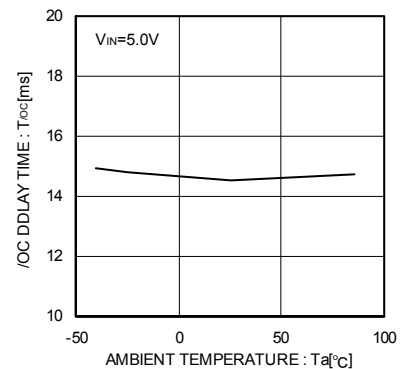

Fig.27 /OC delay time

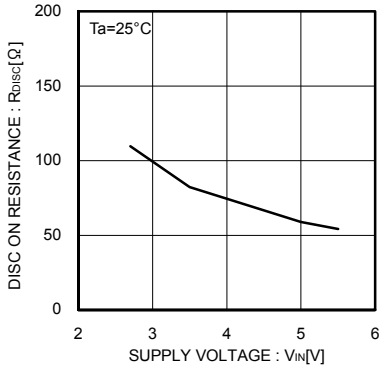

Fig.28 Discharge on resistance

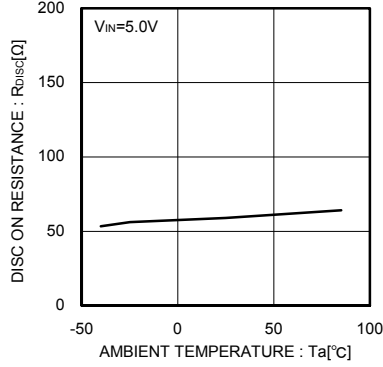

Fig.29 Discharge on resistance

●Waveform Data (BD2240G)

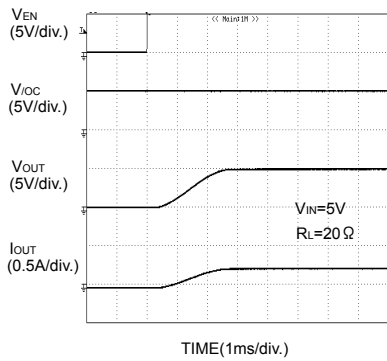

Fig.30 Output rise characteristic

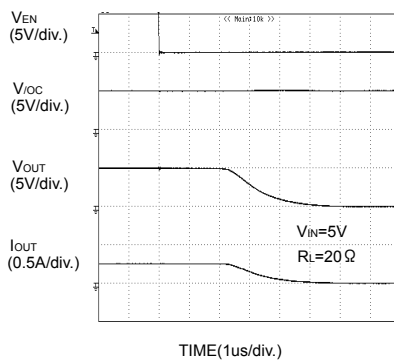

Fig.31 Output fall characteristic

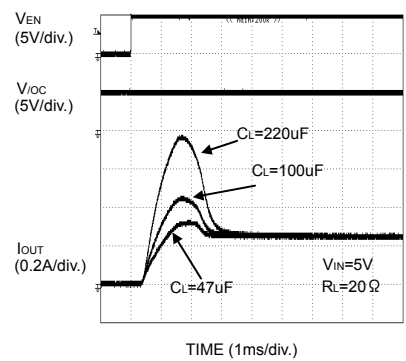

Fig.32 Inrush current response

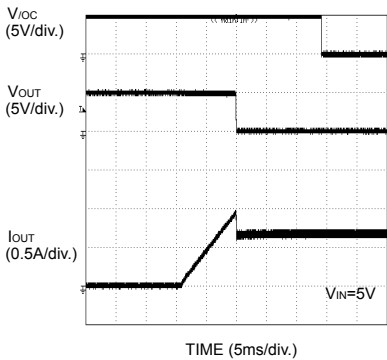

Fig.33 Over-current response ramped load

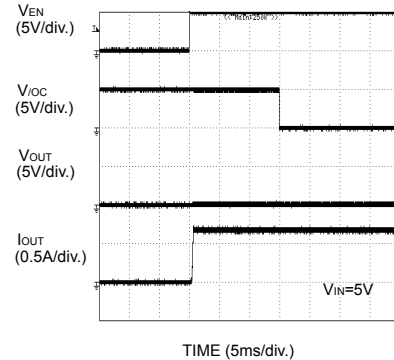

Fig.34 Over-current response enable to shortcircuit

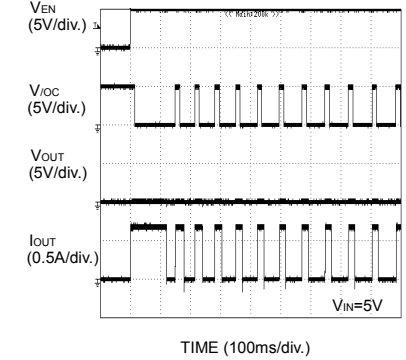

Fig.35 Over-current response enable to shortcircuit

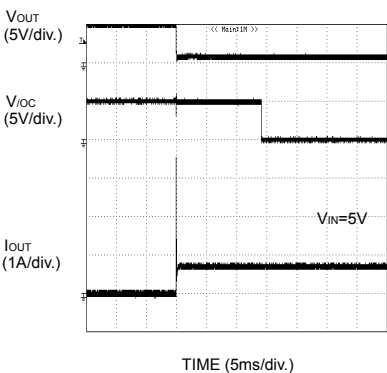

Fig.36 Over-current response 1Ω load to enabled device

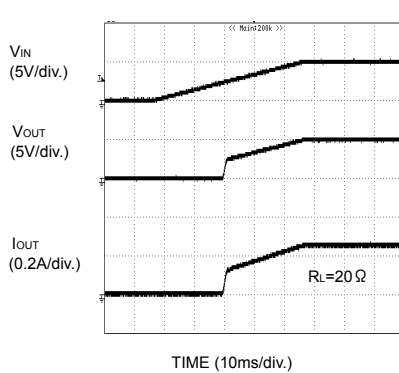

Fig.37 UVLO response increasing Vin

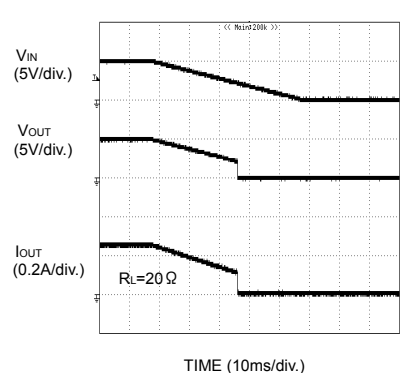

Fig.38 UVLO response decreasing Vin

●Block Diagram

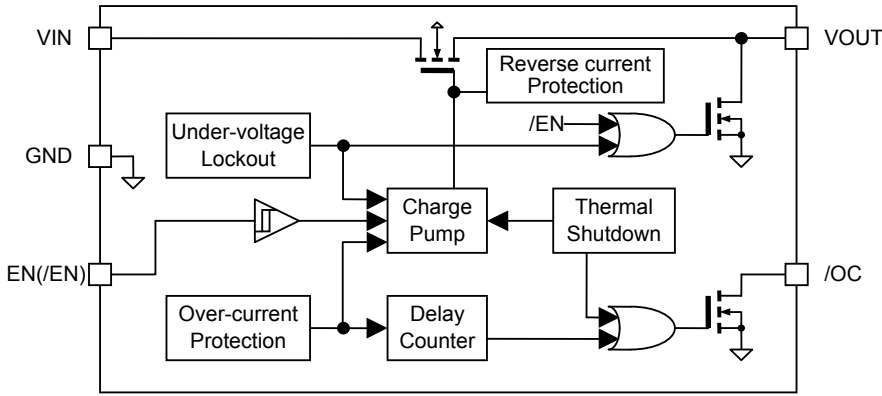

Fig.39 Block diagram

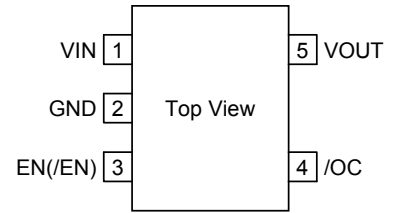

Fig.40 Pin configuration

●Pin Description

Pin No.	Symbol	I/O	Function
1	VIN	-	Switch input and the supply voltage for the IC.
2	GND	-	Ground.
3	EN, /EN	I	Enable input. EN: High level input turns on the switch. (BD2240G) /EN: Low level input turns on the switch. (BD2241G)
4	/OC	O	Over-current notification terminal. Low level output during over-current or over-temperature condition. Open-drain fault flag output.
5	VOUT	O	Switch output.

●I/O Circuit

Symbol	Pin No.	Equivalent Circuit
EN (/EN)	3	
VOUT	5	
/OC	4	

## ●Functional Description

### 1. Switch Operation

VIN terminal and VOUT terminal are connected to the drain and the source of switch MOSFET respectively. And the VIN terminal is used also as power source input to internal control circuit.

When the switch is turned on from EN,/EN control input, VIN terminal and VOUT terminal are connected by a 110mΩ(Typ.) switch. In on status, the switch is bidirectional. Therefore, when the potential of VOUT terminal is higher than that of VIN terminal, current flows from VOUT terminal to VIN terminal.

Since a parasitic diode between the drain and the source of switch MOSFET is canceled, in the off status, it is possible to prevent current from flowing reversely from VOUT to VIN.

### 2. Thermal Shutdown Circuit (TSD)

If over-current would continue, the temperature of the IC would increase drastically. If the junction temperature were beyond 135°C(Typ.) in the condition of over-current detection, thermal shutdown circuit operates and makes power switch turn off and outputs fault flag (/OC). Then, when the junction temperature decreases lower than 115°C(Typ.), power switch is turned on and fault flag (/OC) is cancelled. Unless the fact of the increasing chips temperature is removed or the output of power switch is turned off, this operation repeats.

The thermal shutdown circuit operates when the switch is on (EN,/EN signal is active).

### 3. Over-Current Detection (OCD)

The over-current detection circuit limits current ( $I_{SC}$ ) and outputs fault flag (/OC) when current flowing in each switch MOSFET exceeds a specified value. There are three types of response against over-current. The over-current detection circuit works when the switch is on (EN,/EN signal is active).

#### 3-1. When the switch is turned on while the output is in short-circuit status

When the switch is turned on while the output is in shortcircuit status or so, the switch gets in current limit status soon.

#### 3-2. When the output short-circuits while the switch is on

When the output short-circuits or large capacity is connected while the switch is on, very large current flows until the over-current limit circuit reacts. When the current detection, limit circuit works, current limitation is carried out.

#### 3-3. When the output current increases gradually

When the output current increases gradually, current limitation does not work until the output current exceeds the over-current detection value. When it exceeds the detection value, current limitation is carried out.

### 4. Under-Voltage Lockout (UVLO)

UVLO circuit prevents the switch from turning on until the VIN exceeds 2.3V(Typ.). If the VIN drops below 2.2V(Typ.) while the switch turns on, then UVLO shuts off the power switch. UVLO has hysteresis of a 100mV(Typ).

Under-voltage lockout circuit works when the switch is on (EN,/EN signal is active).

### 5. Fault Flag (/OC) Output

Fault flag output is N-MOS open drain output. At detection of over-current, thermal shutdown, low level is output.

Over-current detection has delay filter. This delay filter prevents instantaneous current detection such as inrush current at switch on, hot plug from being informed to outside.



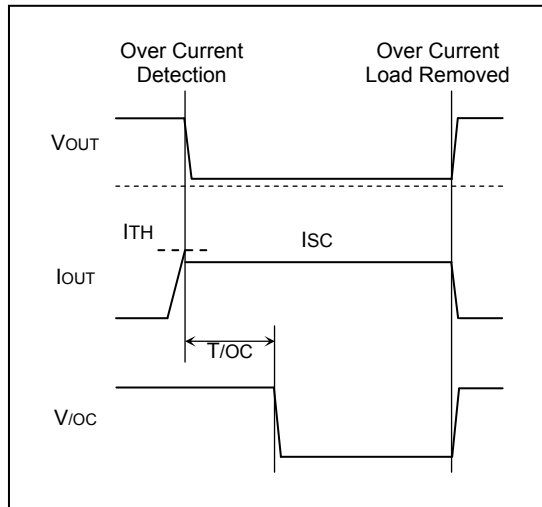

Fig.41 Over-current detection

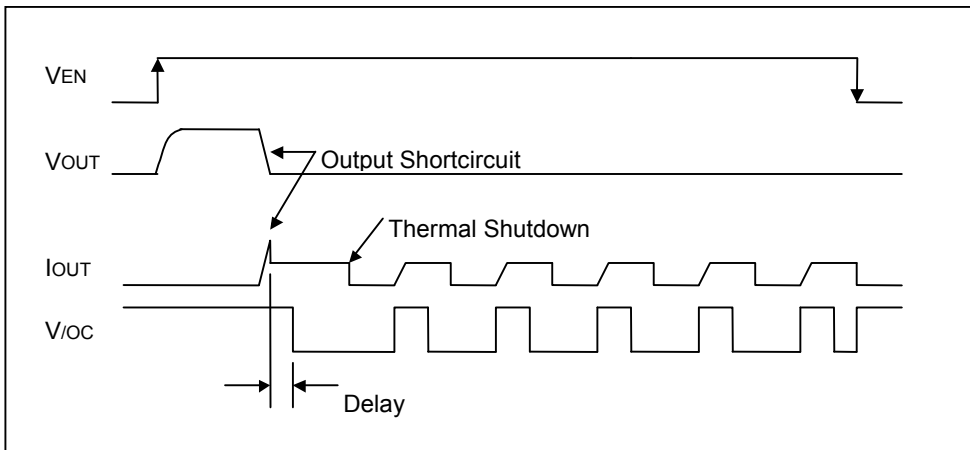

Fig.42 Over-current detection, Thermal shutdown timing (BD2240G)

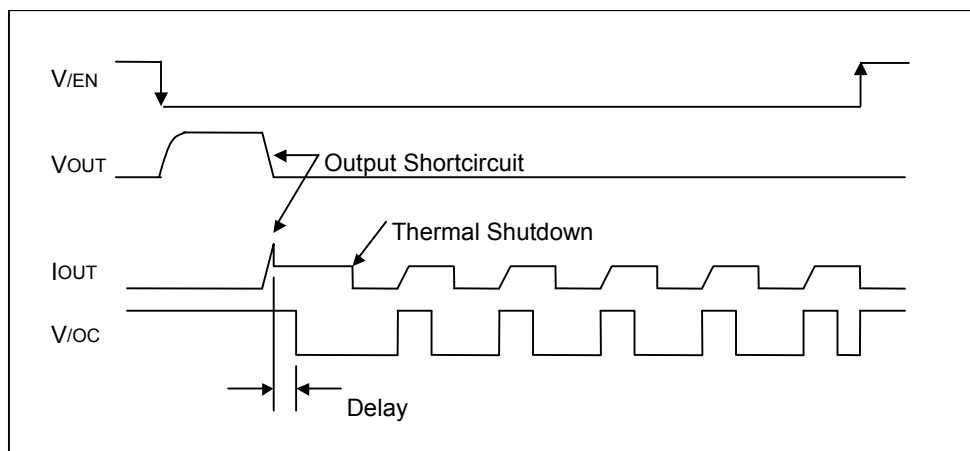

Fig.43 Over-current detection, Thermal shutdown timing (BD2241G)

●Typical Application Circuit

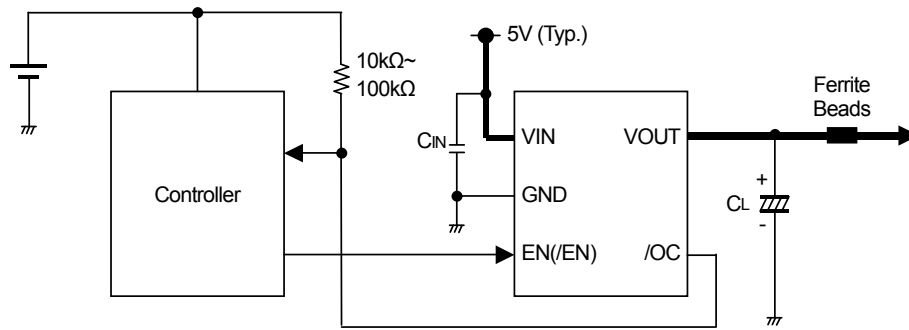

Fig.44 Typical application circuit

●Application Information

When excessive current flows owing to output short-circuit or so, ringing occurs by inductance of power source line to IC, and may cause bad influences upon IC actions. In order to avoid this case, connect a bypass capacitor  $C_{IN}$  by VIN terminal and GND terminal of IC. 1 $\mu$ F or higher is recommended. In order to decrease voltage fluctuations of power source line to IC, connect a low ESR capacitor in parallel with  $C_{IN}$ . 10 $\mu$ F ~ 100 $\mu$ F or higher is effective.

Pull up /OC output by resistance 10k $\Omega$  ~ 100k $\Omega$ .

Set up value which satisfies the application as  $C_L$  and Ferrite Beads.

This system connection diagram doesn't guarantee operating as the application.

When using the circuit with changes to the external circuit constants, make sure to leave an adequate margin for external components including static and transitional characteristics as well as dispersion of the IC.

●Power Dissipation Characteristic  
(SSOP5 package)

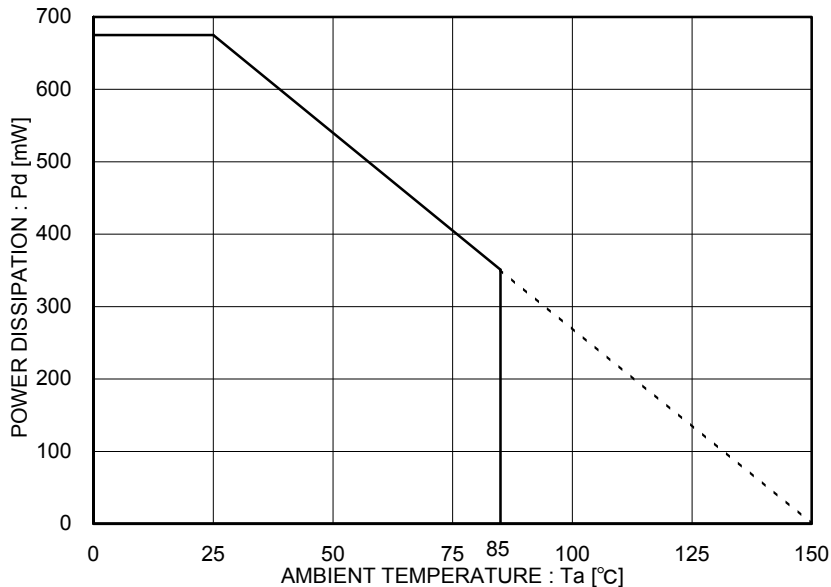

\* 70mm x 70mm x 1.6mm Glass Epoxy Board

Fig.45 Power Dissipation Curve (Pd-Ta Curve)

## ●Notes for use

- (1) Absolute maximum ratings  
An excess in the absolute maximum ratings, such as supply voltage, temperature range of operating conditions, etc., can break down devices, thus making impossible to identify breaking mode such as a short circuit or an open circuit. If any special mode exceeding the absolute maximum ratings is assumed, consideration should be given to take physical safety measures including the use of fuses, etc.
- (2) Operating conditions  
These conditions represent a range within which characteristics can be provided approximately as expected. The electrical characteristics are guaranteed under the conditions of each parameter.
- (3) Reverse connection of power supply connector  
The reverse connection of power supply connector can break down ICs. Take protective measures against the breakdown due to the reverse connection, such as mounting an external diode between the power supply and the IC's power supply terminal.
- (4) Power supply line  
Design PCB pattern to provide low impedance for the wiring between the power supply and the GND lines. In this regard, for the digital block power supply and the analog block power supply, even though these power supplies has the same level of potential, separate the power supply pattern for the digital block from that for the analog block, thus suppressing the diffraction of digital noises to the analog block power supply resulting from impedance common to the wiring patterns. For the GND line, give consideration to design the patterns in a similar manner. Furthermore, for all power supply terminals to ICs, mount a capacitor between the power supply and the GND terminal. At the same time, in order to use an electrolytic capacitor, thoroughly check to be sure the characteristics of the capacitor to be used present no problem including the occurrence of capacity dropout at a low temperature, thus determining the constant.
- (5) GND voltage  
Make setting of the potential of the GND terminal so that it will be maintained at the minimum in any operating state. Furthermore, check to be sure no terminals are at a potential lower than the GND voltage including an actual electric transient.
- (6) Short circuit between terminals and erroneous mounting  
In order to mount ICs on a set PCB, pay thorough attention to the direction and offset of the ICs. Erroneous mounting can break down the ICs. Furthermore, if a short circuit occurs due to foreign matters entering between terminals or between the terminal and the power supply or the GND terminal, the ICs can break down.
- (7) Operation in strong electromagnetic field  
Be noted that using ICs in the strong electromagnetic field can malfunction them.
- (8) Inspection with set PCB  
On the inspection with the set PCB, if a capacitor is connected to a low-impedance IC terminal, the IC can suffer stress. Therefore, be sure to discharge from the set PCB by each process. Furthermore, in order to mount or dismount the set PCB to/from the jig for the inspection process, be sure to turn OFF the power supply and then mount the set PCB to the jig. After the completion of the inspection, be sure to turn OFF the power supply and then dismount it from the jig. In addition, for protection against static electricity, establish a ground for the assembly process and pay thorough attention to the transportation and the storage of the set PCB.
- (9) Input terminals  
In terms of the construction of IC, parasitic elements are inevitably formed in relation to potential. The operation of the parasitic element can cause interference with circuit operation, thus resulting in a malfunction and then breakdown of the input terminal. Therefore, pay thorough attention not to handle the input terminals, such as to apply to the input terminals a voltage lower than the GND respectively, so that any parasitic element will operate. Furthermore, do not apply a voltage to the input terminals when no power supply voltage is applied to the IC. In addition, even if the power supply voltage is applied, apply to the input terminals a voltage lower than the power supply voltage or within the guaranteed value of electrical characteristics.
- (10) Ground wiring pattern  
If small-signal GND and large-current GND are provided, It will be recommended to separate the large-current GND pattern from the small-signal GND pattern and establish a single ground at the reference point of the set PCB so that resistance to the wiring pattern and voltage fluctuations due to a large current will cause no fluctuations in voltages of the small-signal GND. Pay attention not to cause fluctuations in the GND wiring pattern of external parts as well.
- (11) External capacitor  
In order to use a ceramic capacitor as the external capacitor, determine the constant with consideration given to a degradation in the nominal capacitance due to DC bias and changes in the capacitance due to temperature, etc.
- (12) Thermal shutdown circuit (TSD)  
When junction temperatures become detected temperatures or higher, the thermal shutdown circuit operates and turns a switch OFF. The thermal shutdown circuit is aimed at isolating the LSI from thermal runaway as much as possible. Do not continuously use the LSI with this circuit operating or use the LSI assuming its operation.
- (13) Thermal design  
Perform thermal design in which there are adequate margins by taking into account the power dissipation (Pd) in actual states of use.

●Ordering part number

B	D
---	---

Part No.

2	2	4	0
---	---	---	---

Part No.  
2240  
2241

G
---

Package  
G: SSOP5

T	R
---	---

Packaging and forming specification  
TR: Embossed tape and reel

SSOP5

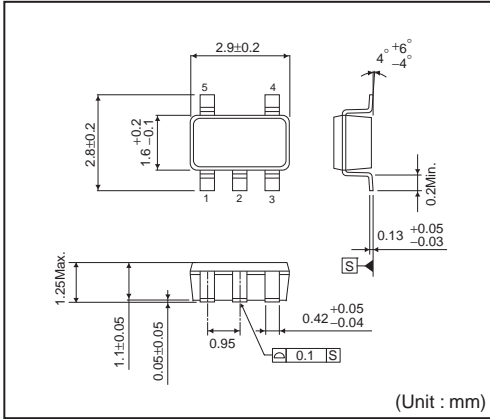

<Tape and Reel information>

Tape	Embossed carrier tape
Quantity	3000pcs
Direction of feed	TR ( The direction is the 1pin of product is at the upper right when you hold reel on the left hand and you pull out the tape on the right hand )

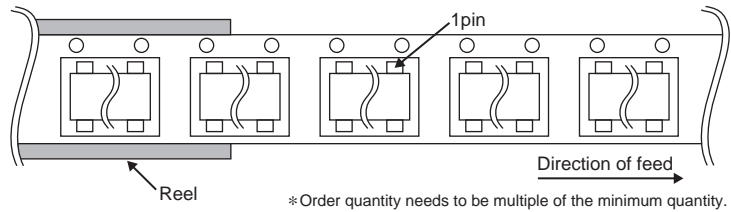

## Notes

No copying or reproduction of this document, in part or in whole, is permitted without the consent of ROHM Co.,Ltd.

The content specified herein is subject to change for improvement without notice.

The content specified herein is for the purpose of introducing ROHM's products (hereinafter "Products"). If you wish to use any such Product, please be sure to refer to the specifications, which can be obtained from ROHM upon request.

Examples of application circuits, circuit constants and any other information contained herein illustrate the standard usage and operations of the Products. The peripheral conditions must be taken into account when designing circuits for mass production.

Great care was taken in ensuring the accuracy of the information specified in this document. However, should you incur any damage arising from any inaccuracy or misprint of such information, ROHM shall bear no responsibility for such damage.

The technical information specified herein is intended only to show the typical functions of and examples of application circuits for the Products. ROHM does not grant you, explicitly or implicitly, any license to use or exercise intellectual property or other rights held by ROHM and other parties. ROHM shall bear no responsibility whatsoever for any dispute arising from the use of such technical information.

The Products specified in this document are intended to be used with general-use electronic equipment or devices (such as audio visual equipment, office-automation equipment, communication devices, electronic appliances and amusement devices).

The Products specified in this document are not designed to be radiation tolerant.

While ROHM always makes efforts to enhance the quality and reliability of its Products, a Product may fail or malfunction for a variety of reasons.

Please be sure to implement in your equipment using the Products safety measures to guard against the possibility of physical injury, fire or any other damage caused in the event of the failure of any Product, such as derating, redundancy, fire control and fail-safe designs. ROHM shall bear no responsibility whatsoever for your use of any Product outside of the prescribed scope or not in accordance with the instruction manual.

The Products are not designed or manufactured to be used with any equipment, device or system which requires an extremely high level of reliability the failure or malfunction of which may result in a direct threat to human life or create a risk of human injury (such as a medical instrument, transportation equipment, aerospace machinery, nuclear-reactor controller, fuel-controller or other safety device). ROHM shall bear no responsibility in any way for use of any of the Products for the above special purposes. If a Product is intended to be used for any such special purpose, please contact a ROHM sales representative before purchasing.

If you intend to export or ship overseas any Product or technology specified herein that may be controlled under the Foreign Exchange and the Foreign Trade Law, you will be required to obtain a license or permit under the Law.



Thank you for your accessing to ROHM product informations.  
More detail product informations and catalogs are available, please contact us.

### ROHM Customer Support System

<http://www.rohm.com/contact/>