

# Dual 12-Bit, 250/200/125 MSPS JESD204B High Speed Serial Output ADC

## ISLA222S

The ISLA222S is a series of low-power, high-performance, dual-channel 12-bit, analog-to-digital converters. Designed with FemtoCharge™ technology on a standard CMOS process, the series supports sampling rates of up to 250MSPS. The ISLA222S is part of a pin-compatible family of 12- and 14-bit dual-channel A/Ds with maximum sample rates ranging from 125MSPS to 250MSPS and shares the same analog core as Intersil's proven ISLA222P series of ADCs. The family minimizes power consumption while providing state-of-the-art dynamic performance, offering an optimal performance-vs-power trade-off.

Differentiating the ISLA222S from the ISLA222P is its highly configurable, JESD204B-compliant, high speed serial output link. The link offers data rates up to 4.375Gbps per lane and multiple packing modes. It can be configured to use one, two, or three lanes to transmit the conversion data, allowing for flexibility in the receiver design. The SERDES transmitter also provides deterministic latency and multi-chip time alignment support to satisfy an application's complex synchronization requirements.

A serial peripheral interface (SPI) port allows for extensive configurability of the JESD204B transmitter including access to its built-in link and transport-layer test patterns. The SPI port also provides control for numerous additional features including the fine gain and offset adjustments of the two ADC cores as well as the programmable clock divider, enabling 2x and 4x harmonic clocking.

The ISLA222S is available in a space-saving 7mmx7mm 48 Ld QFN package. The package features a thermal pad for improved thermal performance and is specified over the full industrial temperature range (-40 °C to +85 °C).

## Features

- JESD204A/B High Speed Data Interface
  - JESD204A Compliant
  - JESD204B Device Subclass 0 Compliant
  - JESD204B Device Subclass 2 Compatible
  - Up to 3 JESD204 Output Lanes Running up to 4.375Gbps
  - Highly Configurable JESD204 Transmitter
- Multiple Chip Time Alignment and Deterministic Latency Support (JESD204B Device Subclass 2)
- SPI Programmable Debugging Features and Test Patterns
- 48-pin QFN 7mmx7mm Package

## Key Specifications

- SNR @ 250/200/125MSPS
  - 70.6/71.2/71.7 dBFS  $f_{IN} = 30\text{MHz}$
  - 70.3/70.7/70.9 dBFS  $f_{IN} = 190\text{MHz}$
- SFDR @ 250/200/125MSPS
  - 87/93/95 dBc  $f_{IN} = 30\text{MHz}$
  - 84/93/86 dBc  $f_{IN} = 190\text{MHz}$
- Total Power Consumption: 989mW @ 250MSPS

## Applications

- Radar and Satellite Antenna Array Processing
- Broadband Communications and Microwave Receivers
- High-Performance Data Acquisition
- Communications Test Equipment
- High-Speed Medical Imaging

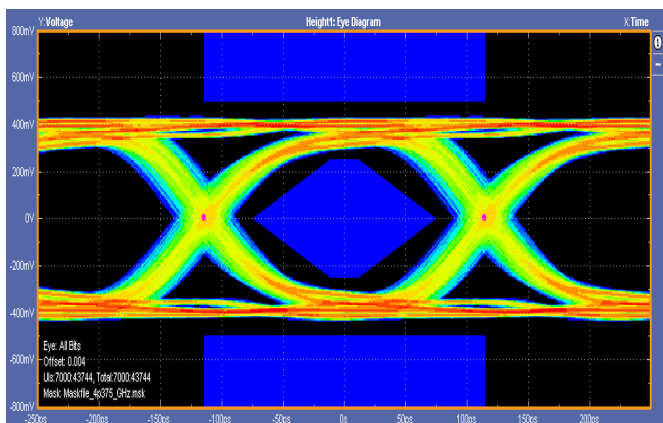

FIGURE 1. SERDES DATA EYE AT 4.375Gbps

## Pin-Compatible Family

MODEL	RESOLUTION	SPEED (MSPS)	PRODUCT AVAILABILITY
ISLA224S25	14	250	Now
ISLA224S20	14	200	Now
ISLA224S12	14	125	Now
ISLA222S25	12	250	Now
ISLA222S20	12	200	Now
ISLA222S12	12	125	Now

# ISLA222S

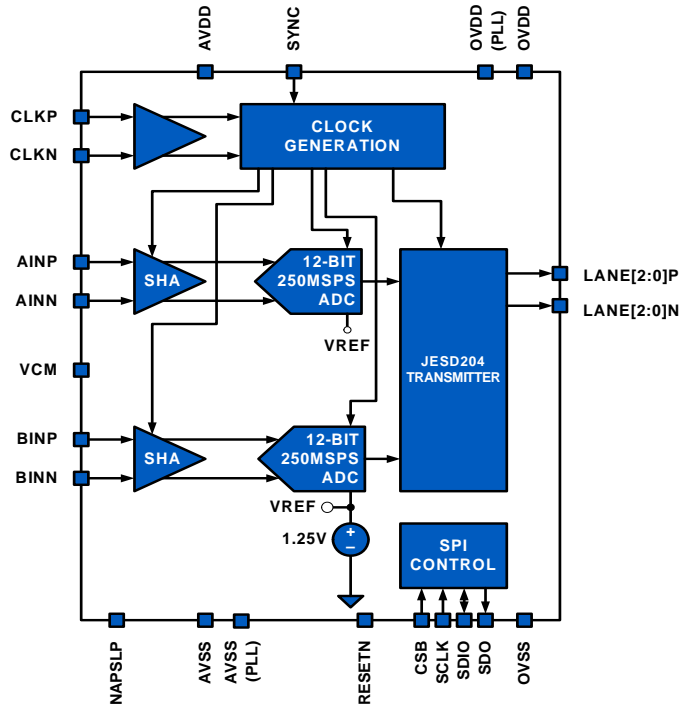
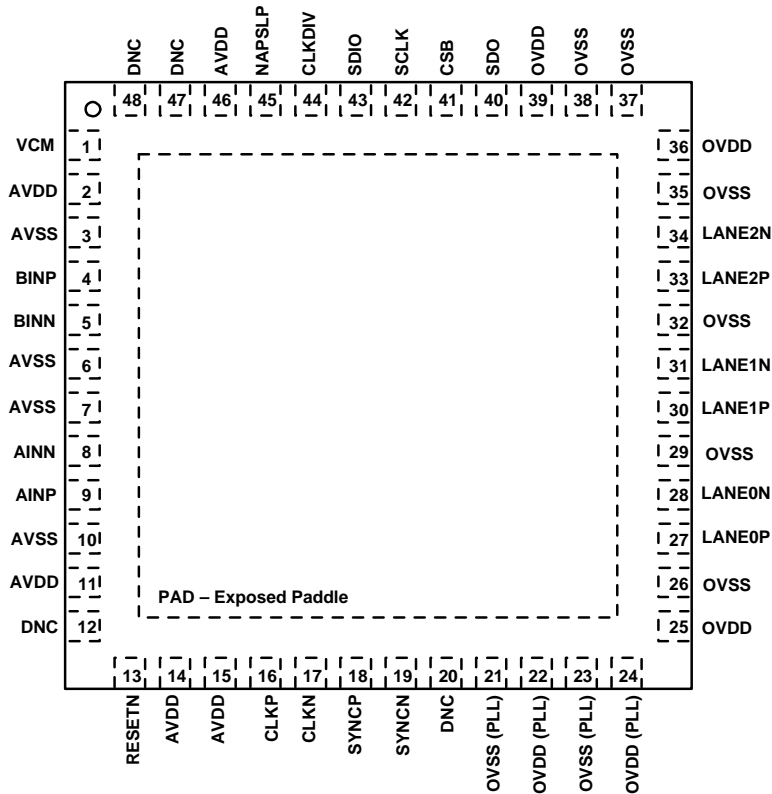

FIGURE 2. BLOCK DIAGRAM

## Pin Configuration

ISLA222S  
(48 LD QFN)  
TOP VIEW



# ISLA222S

## Pin Descriptions

PIN NUMBER	NAME	FUNCTION
2, 11, 14, 15, 46	AVDD	1.8V Analog Supply
12, 20, 47, 48	DNC	Do Not Connect
3, 6, 7, 10	AVSS	Analog Ground
4, 5	BINP, BINN	B-Channel Analog Input Positive, Negative
8, 9	AINN, AINP	A-Channel Analog Input Negative, Positive
1	VCM	Common Mode Output
44	CLKDIV	Clock Divider Control
16, 17	CLKP, CLKN	Clock Input True, Complement
45	NAPSLP	Power Control (Nap, Sleep modes)
13	RESETN	Power On Reset (Active Low)
26, 29, 32, 35, 37, 38	OVSS	Output Ground
25, 36, 39	OVDD	1.8V Digital Supply
22, 24	OVDD (PLL)	1.8V Analog Supply for SERDES PLL
21, 23	OVSS (PLL)	Analog Ground Supply for SERDES PLL
18, 19	SYNCP, SYN CN	JESD204 SYNC Input
27, 28	LANE0P, LANE0N	SERDES Lane 0
30, 31	LANE1P, LANE1N	SERDES Lane 1
33, 34	LANE2P, LANE2N	SERDES Lane 2
40	SDO	SPI Serial Data Output
41	CSB	SPI Chip Select (active low)
42	SCLK	SPI Clock
43	SDIO	SPI Serial Data Input/Output
PAD	AVSS	Exposed Paddle. Analog Ground (connect to AVSS)

## Ordering Information

PART NUMBER (Notes 1, 2)	PART MARKING	TEMP. RANGE (°C)	PACKAGE (Pb-free)	PKG. DWG. #
ISLA222S251R1Z	ISLA222S25 IR1Z	-40 to +85	48 Ld QFN	L48.7x7G
ISLA222S201R1Z	ISLA222S20 IR1Z	-40 to +85	48 Ld QFN	L48.7x7G
ISLA222S121R1Z	ISLA222S12 IR1Z	-40 to +85	48 Ld QFN	L48.7x7G
Coming Soon ISLA224S251R48EV1Z	FMC Based Evaluation Board (Supports 125/200/250 speed grades), Dual 14bit Evaluation Board which can be configured for 12bit operation; Interfaces with ADCMB-HSFMC-EV1Z Motherboard and Other FPGA Vendor FMC Based Evaluation Platforms.			
Coming Soon ADCMB-HSFMC-EV1Z	FMC Based Motherboard			

### NOTES:

- These Intersil Pb-free plastic packaged products employ special Pb-free material sets; molding compounds/die attach materials and NiPdAu plate-e4 termination finish, which is RoHS compliant and compatible with both SnPb and Pb-free soldering operations. Intersil Pb-free products are MSL classified at Pb-free peak reflow temperatures that meet or exceed the Pb-free requirements of IPC/JEDEC J STD-020.
- For Moisture Sensitivity Level (MSL), please see device information page for [ISLA222S12](#), [ISLA222S20](#), [ISLA222S25](#). For more information on MSL please see techbrief [TB363](#).

## Table of Contents

<b>Pin Configuration</b> .....	<b>2</b>	<b>JESD204 Transmitter</b> .....	<b>20</b>
<b>Pin Descriptions</b> .....	<b>3</b>	Overview .....	20
<b>Table of Contents</b> .....	<b>4</b>	Initial Lane Alignment .....	21
<b>Absolute Maximum Ratings</b> .....	<b>5</b>	<b>Test Patterns</b> .....	<b>22</b>
<b>Thermal Information</b> .....	<b>5</b>	<b>Serial Peripheral Interface</b> .....	<b>26</b>
<b>Recommended Operating Conditions</b> .....	<b>5</b>	SPI Physical Interface .....	26
<b>Digital Specifications</b> .....	<b>8</b>	SPI Configuration .....	26
<b>Switching Specifications</b> .....	<b>8</b>	Device Information .....	27
<b>Typical Performance Curves</b> .....	<b>10</b>	Device Configuration/Control .....	27
<b>Theory of Operation</b> .....	<b>15</b>	Global Device Configuration/Control .....	28
Functional Description .....	15	ADDRESS 0xDF - 0xF3: JESD204 REGISTERS .....	29
Power-On Calibration .....	15	Address 0xDF-0xEE: JESD204 Parameter INTERFACE .....	29
User Initiated Reset .....	16	<b>SPI Memory Map</b> .....	<b>32</b>
<b>Temperature Calibration</b> .....	<b>17</b>	<b>Equivalent Circuits</b> .....	<b>36</b>
Analog Input .....	18	<b>ADC Evaluation Platform</b> .....	<b>37</b>
Clock Input .....	18	<b>Layout Considerations</b> .....	<b>37</b>
Jitter .....	19	Split Ground and Power Planes .....	37
Voltage Reference .....	19	Clock Input Considerations .....	37
Digital Outputs .....	19	Exposed Paddle .....	37
Power Dissipation .....	19	Bypass and Filtering .....	37
Nap/Sleep .....	19	CML Outputs .....	37
Data Format .....	20	Unused Inputs .....	37
<b>Clock Divider Synchronous Reset</b> .....	<b>20</b>	<b>Definitions</b> .....	<b>37</b>
<b>Soft Reset</b> .....	<b>20</b>	<b>Revision History</b> .....	<b>38</b>
		<b>Package Outline Drawing</b> .....	<b>39</b>

# ISLA222S

## Absolute Maximum Ratings

AVDD to AVSS	-0.4V to 2.1V
OVDD to OVSS	-0.4V to 2.1V
AVSS to OVSS	-0.3V to 0.3V
Analog Inputs to AVSS	-0.4V to AVDD + 0.3V
Clock Inputs to AVSS	-0.4V to AVDD + 0.3V
Logic Input to AVSS	-0.4V to OVDD + 0.3V
Logic Inputs to OVSS	-0.4V to OVDD + 0.3V
Latchup (Tested per JESD-78C;Class 2,Level A)	100mA

## Thermal Information

Thermal Resistance (Typical)	$\theta_{JA}$ (°C/W)	$\theta_{JC}$ (°C/W)
48 Ld QFN (Notes 3, 4, 5)	24	0.4
Storage Temperature	-65°C to +150°C	
Junction Temperature	+150°C	
Pb-Free Reflow Profile	see link below <a href="http://www.intersil.com/pbfree/Pb-FreeReflow.asp">http://www.intersil.com/pbfree/Pb-FreeReflow.asp</a>	

## Recommended Operating Conditions

Operating Temperature	-40°C to +85°C
-----------------------	----------------

### NOTES:

- $\theta_{JA}$  is measured in free air with the component mounted on a high effective thermal conductivity test board with "direct attach" features. See Tech Brief [TB379](#).
- For  $\theta_{JC}$ , the "case temp" location is the center of the exposed metal pad on the package underside.
- For solder stencil layout and reflow guidelines, please see Tech Brief [TB389](#).

CAUTION: Do not operate at or near the maximum ratings listed for extended periods of time. Exposure to such conditions may adversely impact product reliability and result in failures not covered by warranty.

**Electrical Specifications** All specifications apply under the following conditions unless otherwise noted: AVDD = 1.8V, OVDD = 1.8V,  $T_A$  = -40°C to +85°C (typical specifications at +25°C),  $A_{IN}$  = -2dBFS,  $f_{SAMPLE}$  = Maximum Conversion Rate (per speed grade). **Boldface limits apply over the operating temperature range, -40°C to +85°C.**

PARAMETER	SYMBOL	CONDITIONS	ISLA222S25			ISLA222S20			ISLA222S12			UNITS
			MIN (Note 6)	TYP	MAX (Note 6)	MIN (Note 6)	TYP	MAX (Note 6)	MIN (Note 6)	TYP	MAX (Note 6)	
<b>DC SPECIFICATIONS</b>												
<b>Analog Input</b>												
Full-Scale Analog Input Range	$V_{FS}$	Differential	<b>1.9</b>	2.00	<b>2.1</b>	<b>1.9</b>	2.0	<b>2.1</b>	<b>1.9</b>	2.0	<b>2.1</b>	$V_{P-P}$
Input Resistance	$R_{IN}$	Differential		600			600			600		$\Omega$
Input Capacitance	$C_{IN}$	Differential		7.4			7.4			7.4		pF
Full Scale Range Temp. Drift	$A_{VTC}$	Full Temp		<b>115</b>			<b>58</b>			<b>58</b>		ppm/°C
Input Offset Voltage	$V_{OS}$			$\pm 1$			$\pm 1$			$\pm 1$		mV
Gain Error	$E_G$			<b>1</b>			<b>1</b>			<b>1</b>		%
Common-Mode Output Voltage	$V_{CM}$			0.94			0.94			0.94		V
Common Mode Input Current (per pin)	$I_{CM}$			6.0			6.0			6.0		$\mu A/MSPS$
<b>Clock Inputs</b>												
Inputs Common Mode Voltage				0.9			0.9			0.9		V
CLKP, CLKN Swing				<b>1.8</b>			<b>1.8</b>			<b>1.8</b>		V
<b>Power Requirements</b>												
1.8V Analog Supply Voltage	AVDD			<b>1.8</b>			<b>1.8</b>			<b>1.8</b>		V
1.8V Digital Supply Voltage	OVDD			<b>1.8</b>			<b>1.8</b>			<b>1.8</b>		V
1.8V Analog Supply Current	$I_{AVDD}$			353	<b>397</b>		324	<b>365</b>		282	<b>316</b>	mA
1.8V Digital Supply Current	$I_{OVDD}$	Minimum number of lanes active		195	<b>218</b>		179	<b>200</b>		123	<b>173</b>	mA

# ISLA222S

**Electrical Specifications** All specifications apply under the following conditions unless otherwise noted: AVDD = 1.8V, OVDD = 1.8V, T<sub>A</sub> = -40°C to +85°C (typical specifications at +25°C), A<sub>IN</sub> = -2dBFS, f<sub>SAMPLE</sub> = Maximum Conversion Rate (per speed grade). **Boldface limits apply over the operating temperature range, -40°C to +85°C. (Continued)**

PARAMETER	SYMBOL	CONDITIONS	ISLA222S25			ISLA222S20			ISLA222S12			UNITS
			MIN (Note 6)	TYP	MAX (Note 6)	MIN (Note 6)	TYP	MAX (Note 6)	MIN (Note 6)	TYP	MAX (Note 6)	
Power Supply Rejection Ratio (Note 7)	PSRR	30MHz 200mVp-p		40			40			40		dB
		1MHz 200mVp-p		47			47			47		dB
<b>Total Power Dissipation</b>												
Normal Mode	P <sub>D</sub>			989	<b>1107</b>		910	<b>1017</b>		731	<b>843</b>	mW
Nap Mode	P <sub>D</sub>			422	<b>484</b>		391	<b>450</b>		290	<b>398</b>	mW
Sleep Mode	P <sub>D</sub>	CSB at logic high		6	<b>12</b>		6	<b>12</b>		6	<b>12</b>	mW
Nap Mode Wakeup Time		Sample Clock Running		5			5			5		μs
Sleep Mode Wakeup Time		Sample Clock Running		1			1			1		ms
<b>AC SPECIFICATIONS (Note 8)</b>												
Differential Nonlinearity	DNL	f <sub>IN</sub> =105MHz <b>No Missing Codes</b>	<b>-1.0</b>	±0.15		<b>-1.0</b>	±0.1		<b>-1.0</b>	±0.1		LSB
Integral Nonlinearity	INL		<b>-1.5</b>	0.8	<b>1.5</b>	<b>-1.0</b>	0.4	<b>1.0</b>	<b>-1.0</b>	0.5	<b>1.0</b>	LSB
Minimum Conversion Rate (Note 9)	f <sub>S</sub> MIN	ISLA222S25/20 (3 Lanes, Efficient Packing)		100			100			50		MSPS
		ISLA222S12 (2 Lanes, Simple Packing)										
Maximum Conversion Rate	f <sub>S</sub> MAX	Efficient Packing	<b>250</b>			<b>200</b>			<b>125</b>			MSPS
		Simple Packing										MSPS
Minimum Serdes Lane Data Rate		Independent of Packing Mode		1.0			1.0			1.0		GBPS
Maximum Serdes Lane Data Rate  (See "Lane data rate" on page 22.)		Independent of Packing Mode	<b>3.75</b>	4.375		<b>3.0</b>	4.375		<b>3.75</b>	4.375		GBPS
Signal-to-Noise Ratio (Note 10)	SNR	f <sub>IN</sub> = 30MHz		70.6			71.2			71.7		dBFS
		f <sub>IN</sub> = 105MHz	<b>69.4</b>	70.6		<b>70.3</b>	71.1		<b>70.7</b>	71.5		dBFS
		f <sub>IN</sub> = 190MHz		70.3			70.7			70.9		dBFS
		f <sub>IN</sub> = 363MHz		69.4			69.5			69.3		dBFS
		f <sub>IN</sub> = 495MHz		68.6			68.5			68.0		dBFS
		f <sub>IN</sub> = 605MHz		67.9			67.6			66.9		dBFS

# ISLA222S

**Electrical Specifications** All specifications apply under the following conditions unless otherwise noted: AVDD = 1.8V, OVDD = 1.8V, TA = -40°C to +85°C (typical specifications at +25°C), AIN = -2dBFS, fSAMPLE = Maximum Conversion Rate (per speed grade). **Boldface limits apply over the operating temperature range, -40°C to +85°C. (Continued)**

PARAMETER	SYMBOL	CONDITIONS	ISLA222S25			ISLA222S20			ISLA222S12			UNITS
			MIN (Note 6)	TYP	MAX (Note 6)	MIN (Note 6)	TYP	MAX (Note 6)	MIN (Note 6)	TYP	MAX (Note 6)	
Signal-to-Noise and Distortion (Note 10)	SINAD	f <sub>IN</sub> = 30MHz		70.5			71.1			71.7		dBFS
		f <sub>IN</sub> = 105MHz	<b>69.0</b>	70.4		<b>70.2</b>	71.0		<b>70.4</b>	71.3		dBFS
		f <sub>IN</sub> = 190MHz		70.0			70.5			70.7		dBFS
		f <sub>IN</sub> = 363MHz		69.0			68.9			67.8		dBFS
		f <sub>IN</sub> = 495MHz		65.4			64.0			61.4		dBFS
		f <sub>IN</sub> = 605MHz		59.3			58.0			54.1		dBFS
Effective Number of Bits (Note 10)	ENOB	f <sub>IN</sub> = 30MHz		11.42			11.52			11.61		Bits
		f <sub>IN</sub> = 105MHz	<b>11.17</b>	11.40		<b>11.37</b>	11.50		<b>11.40</b>	11.55		Bits
		f <sub>IN</sub> = 190MHz		11.34			11.42			11.46		Bits
		f <sub>IN</sub> = 363MHz		11.16			11.16			10.97		Bits
		f <sub>IN</sub> = 495MHz		10.57			10.34			9.91		Bits
		f <sub>IN</sub> = 605MHz		9.56			9.35			8.69		Bits
Spurious-Free Dynamic Range (Note 10)	SFDR	f <sub>IN</sub> = 30MHz		87			93			95		dBc
		f <sub>IN</sub> = 105MHz	<b>74</b>	83		<b>76</b>	89		<b>76</b>	87		dBc
		f <sub>IN</sub> = 190MHz		84			93			86		dBc
		f <sub>IN</sub> = 363MHz		79			88			71		dBc
		f <sub>IN</sub> = 495MHz		66			85			61		dBc
		f <sub>IN</sub> = 605MHz		58			83			52		dBc
Spurious-Free Dynamic Range Excluding H2, H3 (Note 10)	SFDRX23	f <sub>IN</sub> = 30MHz		87			93			98		dBc
		f <sub>IN</sub> = 105MHz		89			95			96		dBc
		f <sub>IN</sub> = 190MHz		88			93			90		dBc
		f <sub>IN</sub> = 363MHz		84			88			85		dBc
		f <sub>IN</sub> = 495MHz		85			85			82		dBc
		f <sub>IN</sub> = 605MHz		88			83			81		dBc
Intermodulation Distortion	IMD	f <sub>IN</sub> = 70MHz		-84			-82			-81		dBFS
		f <sub>IN</sub> = 170MHz		-92			-99			-100		dBFS
Channel-to-Channel Isolation		f <sub>IN</sub> = 10MHz		88			90			100		dB
		f <sub>IN</sub> = 124MHz		82			87			86		dB
Word Error Rate	WER			10 <sup>-13</sup>			10 <sup>-13</sup>			10 <sup>-13</sup>		
Full Power Bandwidth	FPBW			675			675			675		MHz

**NOTES:**

- Compliance to datasheet limits is assured by one or more methods: production test, characterization and/or design.
- PSRR is calculated by the equation  $20 \cdot \log_{10}(A/B)$ , where B is the amplitude of a disturber sinusoid on AVDD at the device pins, and A is the amplitude of the spur in the captured data at the frequency of the disturber sinusoid.
- AC Specifications apply after internal calibration of the ADC is invoked at the given sample rate and temperature. Refer to "Power-On Calibration" on page 15 and "User Initiated Reset" on page 16 for more detail.
- The DLL Range setting must be changed via SPI for ADC core sample rates below 80MSPS. The JESD204 transmitter can support ADC sample rates below 100MSPS, as long as the SERDES lane data rate is greater than or equal to 1Gbps.
- Minimum specification guaranteed when calibrated at +85°C.

# ISLA222S

## Digital Specifications **Boldface limits apply over the operating temperature range, -40 °C to +85 °C.**

PARAMETER	SYMBOL	CONDITIONS	MIN (Note 6)	TYP	MAX (Note 6)	UNITS
<b>CMOS INPUTS</b>						
Input Current High (RESETN)	$I_{IH}$	$V_{IN} = 1.8V$		1	<b>10</b>	$\mu A$
Input Current Low (RESETN)	$I_{IL}$	$V_{IN} = 0V$	<b>-25</b>	-12	<b>-7</b>	$\mu A$
Input Current High (SDIO, SCL, SDA SCLK)	$I_{IH}$	$V_{IN} = 1.8V$		4	<b>12</b>	$\mu A$
Input Current Low (SDIO, SCL, SDA SCLK)	$I_{IL}$	$V_{IN} = 0V$	<b>-600</b>	-400	<b>-300</b>	$\mu A$
Input Current High (CSB)	$I_{IH}$	$V_{IN} = 1.8V$	40	52	<b>70</b>	$\mu A$
Input Current Low (CSB)	$I_{IL}$	$V_{IN} = 0V$		1	<b>10</b>	$\mu A$
Input Voltage High (SDIO, RESETN)	$V_{IH}$		<b>1.17</b>			V
Input Voltage Low (SDIO, RESETN)	$V_{IL}$				<b>0.63</b>	V
Input Current High (NAPSLP, CLKDIV) (Note 11)	$I_{IH}$		<b>19</b>	25	<b>30</b>	$\mu A$
Input Current Low (NAPSLP, CLKDIV)	$I_{IL}$		<b>-30</b>	-25	<b>-19</b>	$\mu A$
Input Capacitance	$C_{DI}$			4		pF
<b>LVDS INPUTS (SYNCP, SYNCN)</b>						
Input Common Mode Range	$V_{ICM}$		<b>825</b>		<b>1575</b>	mV
Input Differential Swing (peak-to-peak, single-ended)	$V_{ID}$		<b>250</b>		<b>450</b>	mV
Input Pull-up and Pull-down Resistance	$R_{Ipu}$			100		k $\Omega$
<b>CML OUTPUTS</b>						
Output Common Mode Voltage				1.14		V

## Switching Specifications **Boldface limits apply over the operating temperature range, -40 °C to +85 °C.**

PARAMETER	SYMBOL	CONDITION	MIN (Note 6)	TYP	MAX (Note 6)	UNITS
<b>ADC OUTPUT</b>						
Aperture Delay	$t_A$			190		ps
RMS Aperture Jitter	$j_A$			100		fs
Synchronous Clock Divider Reset Recovery Time (Note 12)	$t_{RSTRT}$	DLL recovery time after Synchronous Reset		250		$\mu s$
Latency (ADC Pipeline Delay)	L			10		cycles
Overvoltage Recovery	$t_{OVR}$			1		cycles
<b>SERDES</b>						
PLL Lock Time				250		$\mu s$
PLL Bandwidth				2.2		MHz
Added Random Jitter				5		ps RMS
Added Deterministic Jitter				7		ps P-P
Maximum Input Sample Clock Total Jitter to Maintain SERDES BER <1E-12		Integrated from 1kHz to 10MHz offset from carrier		5		ps rms



# ISLA222S

## Switching Specifications **Boldface limits apply over the operating temperature range, -40 °C to +85 °C. (Continued)**

PARAMETER	SYMBOL	CONDITION	MIN (Note 6)	TYP	MAX (Note 6)	UNITS
<b>LVDS Inputs</b>						
SYNCP, SYNCN Setup Time (with Respect to the Positive Edge of CLKP)	$t_{RSTS}$	AVDD, OVDD = 1.7V to 1.9V, $T_A = -40^\circ\text{C}$ to $+85^\circ\text{C}$	<b>400</b>	75		ps
SYNCP, SYNCN Hold Time (with respect to the positive edge of CLKP)	$t_{RSTH}$	AVDD, OVDD = 1.7V to 1.9V, $T_A = -40^\circ\text{C}$ to $+85^\circ\text{C}$		150	<b>350</b>	ps
<b>CML Outputs</b>						
Output Rise Time	$t_R$			165		ps
Output Fall Time	$t_F$			145		ps
Data Output Duty Cycle				50		%
Differential Output Resistance				100		$\Omega$
Differential Output Voltage (Note 13)				760		mV <sub>p-p</sub>
<b>SPI INTERFACE (Notes 14, 15)</b>						
SCLK Period	$t_{CLK}$	Write Operation	<b>7</b>			cycles
	$t_{CLK}$	Read Operation	<b>16</b>			cycles
CSB $\downarrow$ to SCLK $\uparrow$ Setup Time	$t_S$	Read or Write	<b>2</b>			cycles
CSB $\uparrow$ after SCLK $\uparrow$ Hold Time	$t_H$	Read or Write	<b>5</b>			cycles
Data Valid to SCLK $\uparrow$ Setup Time	$t_{DS}$	Read or Write	<b>6</b>			cycles
Data Valid after SCLK $\uparrow$ Hold Time	$t_{DH}$	Read or Write	<b>4</b>			cycles
Data Valid after SCLK $\downarrow$ Time	$t_{DVR}$	Read			<b>4</b>	cycles

### NOTES:

- The Tri-Level Inputs internal switching thresholds are approximately 0.43V and 1.34V. It is advised to float the inputs, tie to ground or AVDD depending on desired function.
- The synchronous clock divider reset function is available as a (SPI-programmable) overload on the SYNC input.
- The voltage is expressed in peak-to-peak differential swing. The peak-to-peak single-ended swing is 1/2 of the differential swing.
- The SPI interface timing is directly proportional to the ADC sample period ( $t_S$ ). Values above reflect multiples of a 4ns sample period, and must be scaled proportionally for lower sample rates. ADC sample clock must be running for SPI communication.
- The SPI may operate asynchronously with respect to the ADC sample clock.

## Typical Performance Curves

All Typical Performance Characteristics apply under the following conditions unless otherwise noted: AVDD = OVDD = 1.8V, T<sub>A</sub> = +25°C, A<sub>IN</sub> = -2dBFS, f<sub>IN</sub> = 105MHz, f<sub>SAMPLE</sub> = 250MSPS.

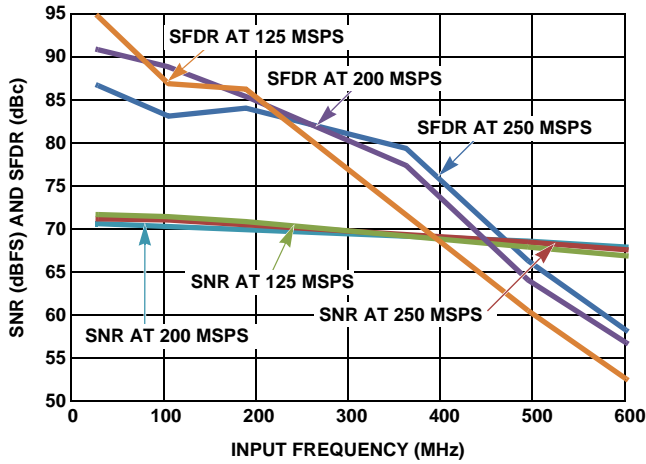

FIGURE 3. SNR AND SFDR vs f<sub>IN</sub>

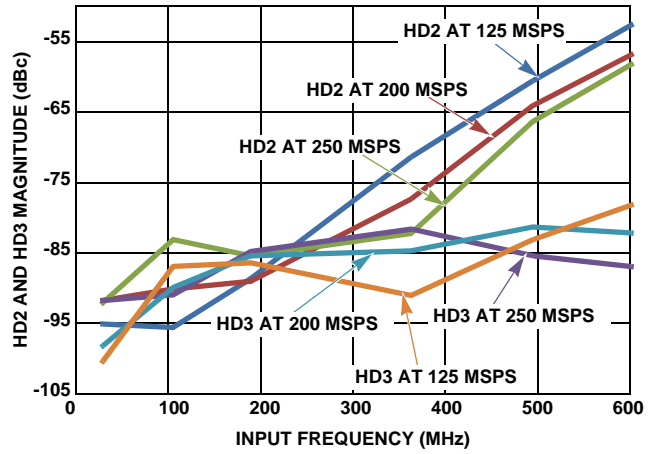

FIGURE 4. HD2 AND HD3 vs f<sub>IN</sub>

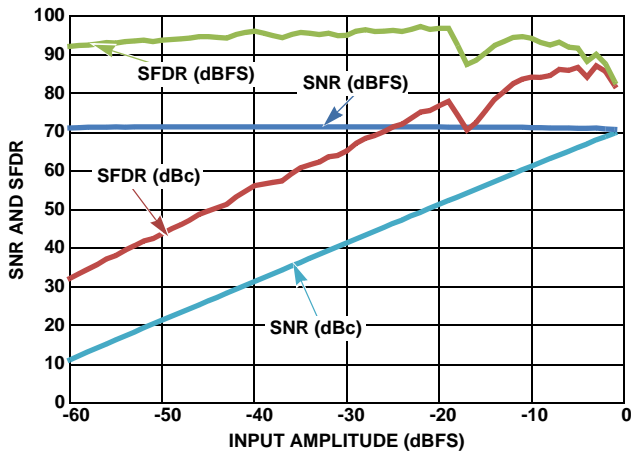

FIGURE 5. SNR AND SFDR vs A<sub>IN</sub> (250MSPS)

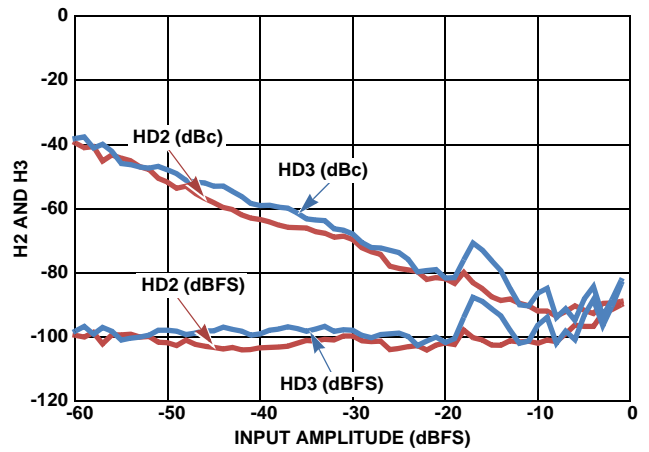

FIGURE 6. HD2 AND HD3 vs A<sub>IN</sub> (250MSPS)

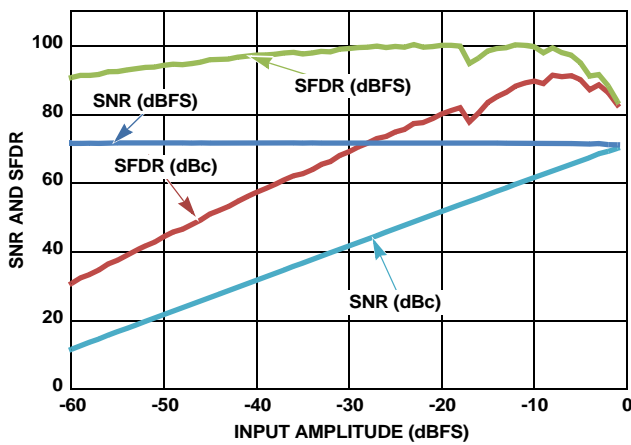

FIGURE 7. SNR AND SFDR vs A<sub>IN</sub> (125MSPS)

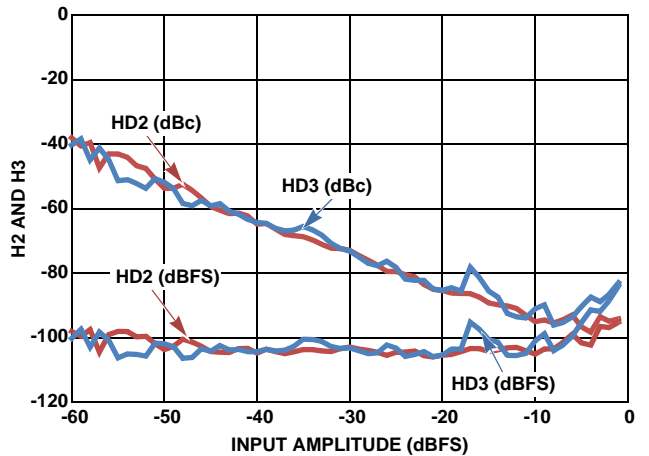

FIGURE 8. H2 AND H3 vs A<sub>IN</sub> (125MSPS)

## Typical Performance Curves

All Typical Performance Characteristics apply under the following conditions unless otherwise noted: AVDD = OVDD = 1.8V, T<sub>A</sub> = +25°C, A<sub>IN</sub> = -2dBFS, f<sub>IN</sub> = 105MHz, f<sub>SAMPLE</sub> = 250MSPS. (Continued)

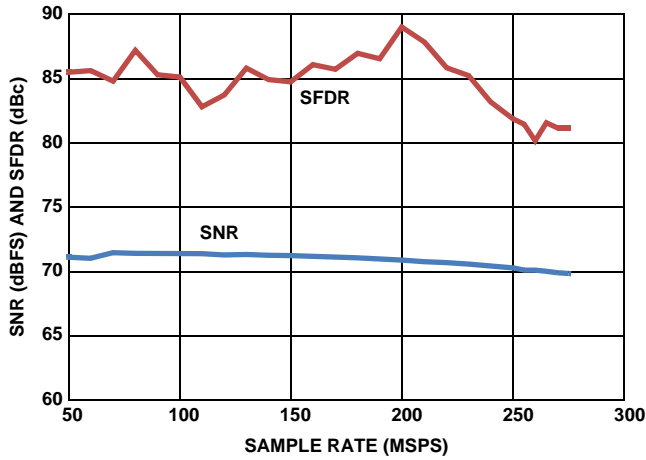

FIGURE 9. SNR AND SFDR vs f<sub>SAMPLE</sub>

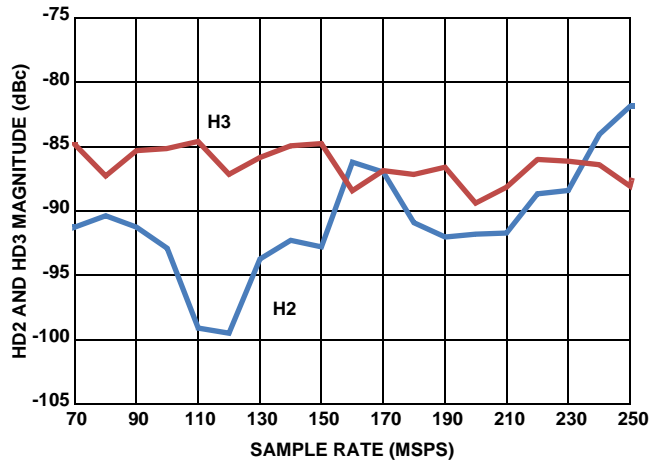

FIGURE 10. HD2 AND HD3 vs f<sub>SAMPLE</sub>

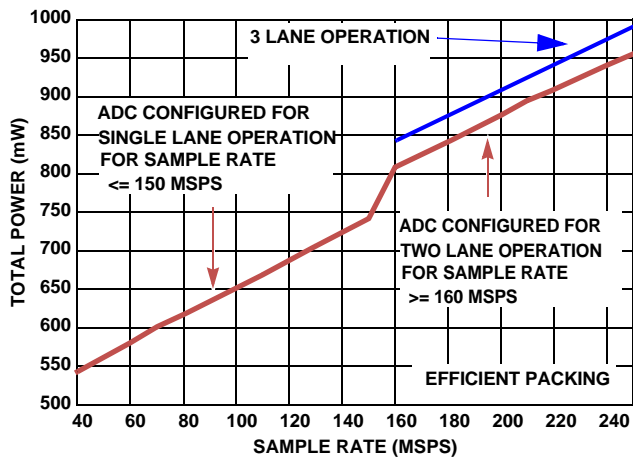

FIGURE 11. POWER vs f<sub>SAMPLE</sub>

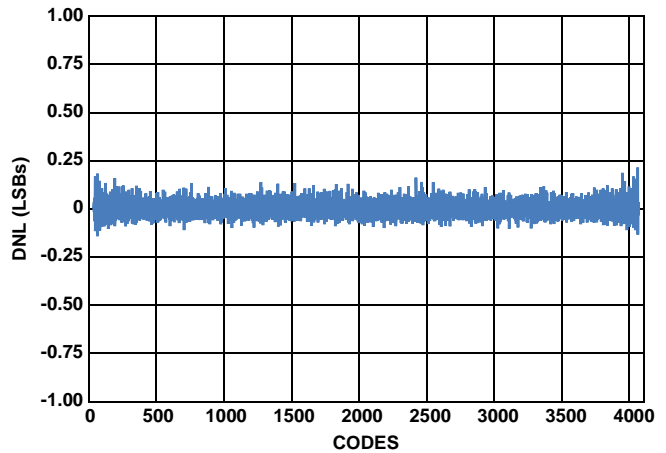

FIGURE 12. DIFFERENTIAL NONLINEARITY (250MSPS)

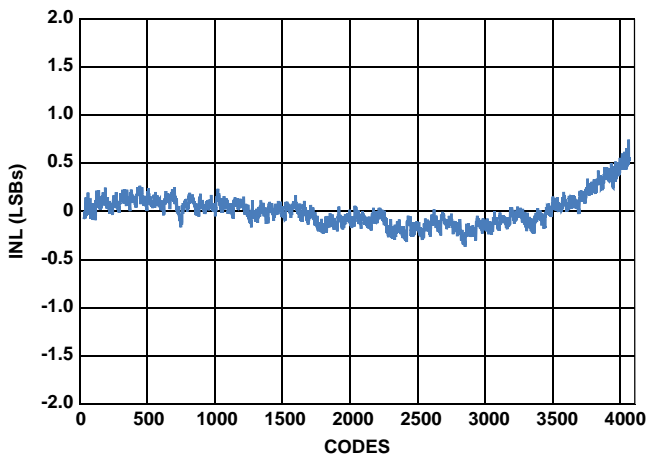

FIGURE 13. INTEGRAL NONLINEARITY (250MSPS)

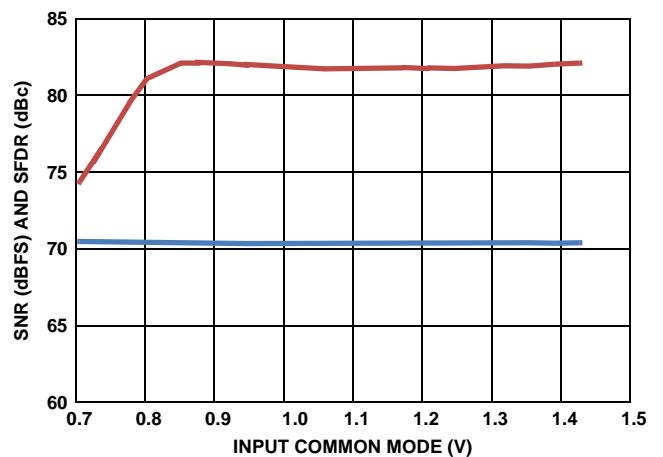

FIGURE 14. SNR AND SFDR vs VCM (250MSPS)

## Typical Performance Curves

All Typical Performance Characteristics apply under the following conditions unless otherwise noted: AVDD = OVDD = 1.8V, T<sub>A</sub> = +25°C, A<sub>IN</sub> = -2dBFS, f<sub>IN</sub> = 105MHz, f<sub>SAMPLE</sub> = 250MSPS. (Continued)

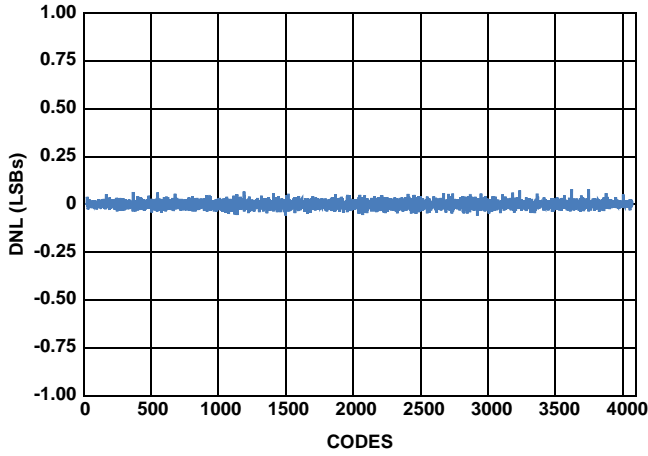

FIGURE 15. DIFFERENTIAL NONLINEARITY (125MSPS)

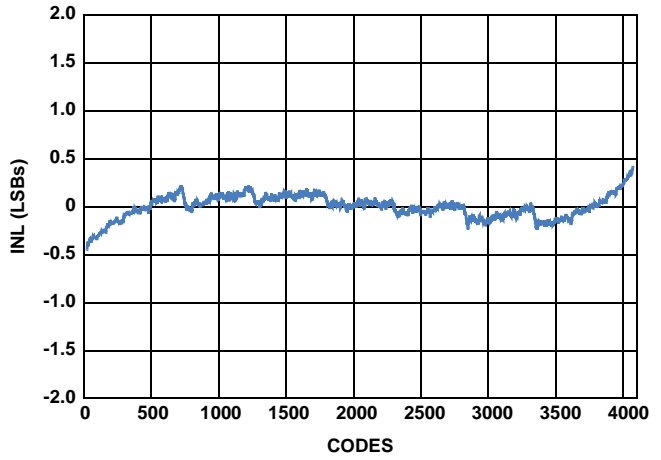

FIGURE 16. INTEGRAL NONLINEARITY (125MSPS)

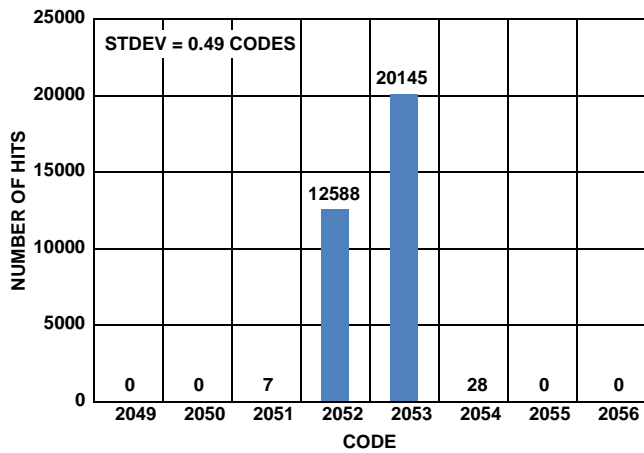

FIGURE 17. NOISE HISTOGRAM (250MSPS)

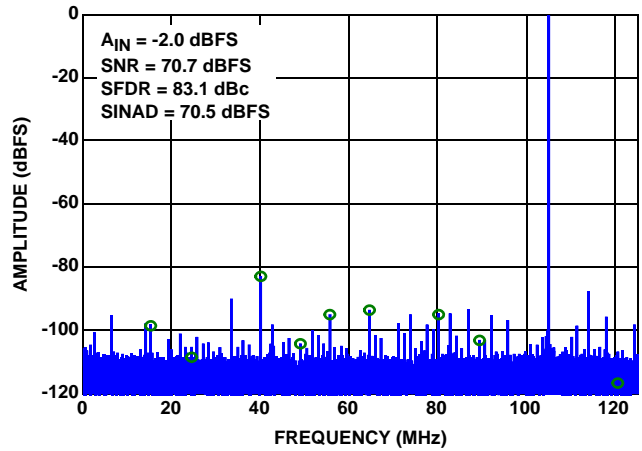

FIGURE 18. SINGLE-TONE SPECTRUM @ 105MHz (250MSPS)

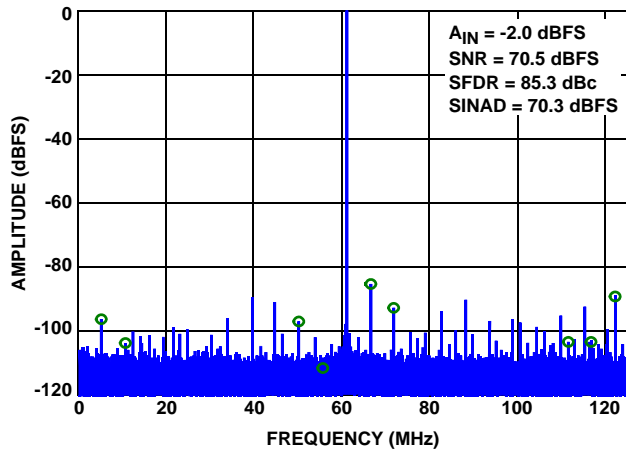

FIGURE 19. SINGLE-TONE SPECTRUM @ 190MHz (250MSPS)

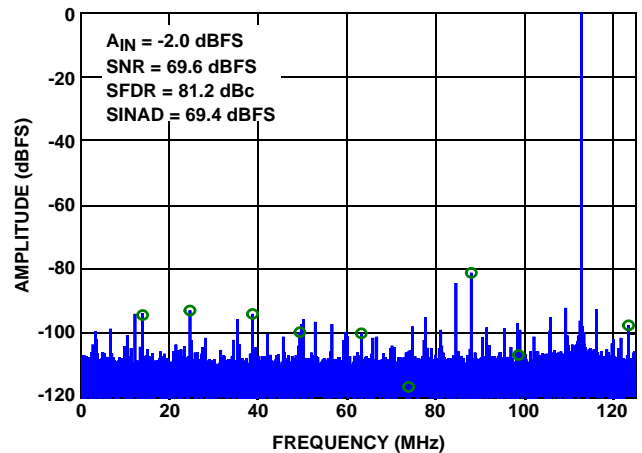

FIGURE 20. SINGLE-TONE SPECTRUM @ 363MHz (250MSPS)

## Typical Performance Curves

All Typical Performance Characteristics apply under the following conditions unless otherwise noted: AVDD = OVDD = 1.8V, T<sub>A</sub> = +25°C, A<sub>IN</sub> = -2dBFS, f<sub>IN</sub> = 105MHz, f<sub>SAMPLE</sub> = 250MSPS. (Continued)

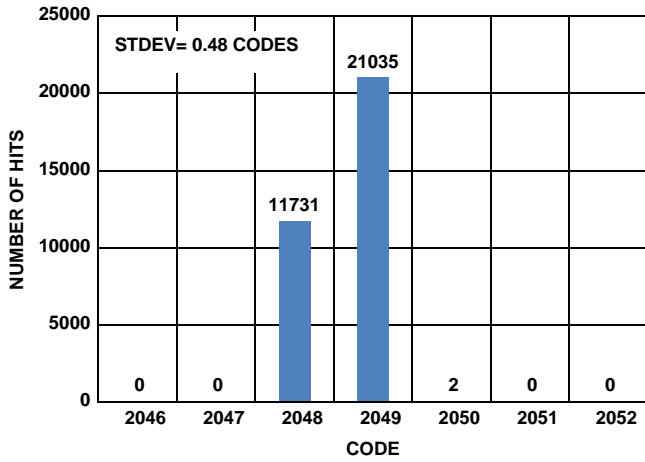

FIGURE 21. NOISE SPECTRUM (125MSPS)

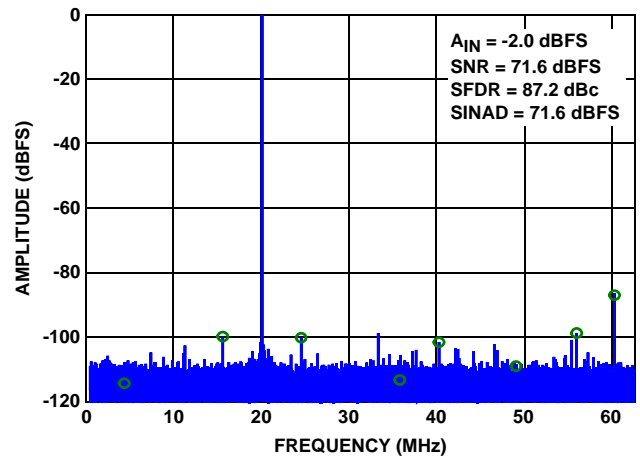

FIGURE 22. SINGLE-TONE SPECTRUM @ 105MHz (125MSPS)

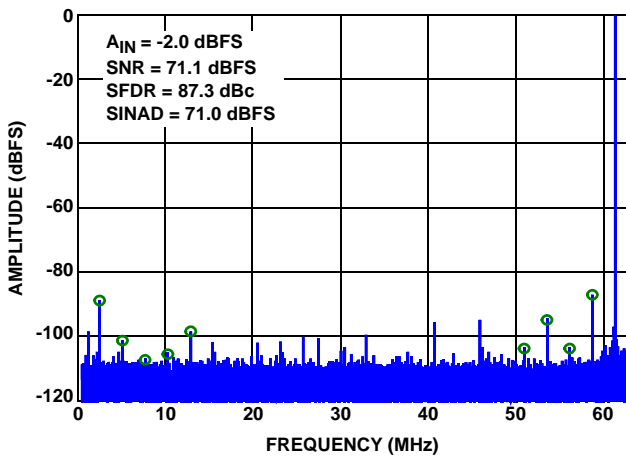

FIGURE 23. SINGLE-TONE SPECTRUM @ 190MHz (125MSPS)

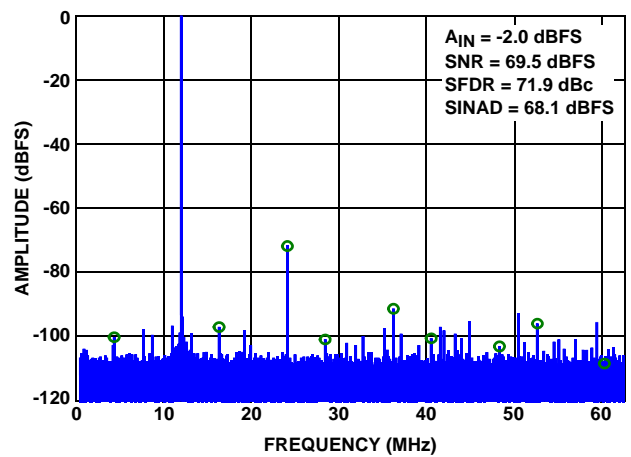

FIGURE 24. SINGLE-TONE SPECTRUM @ 363MHz (125MSPS)

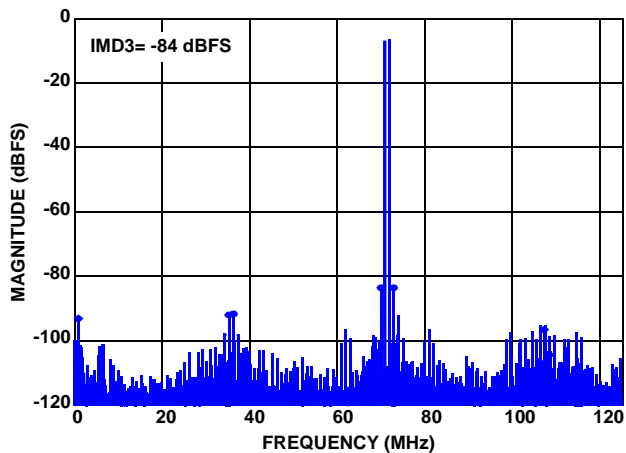

FIGURE 25. TWO-TONE SPECTRUM (F1 = 70MHz, F2 = 71MHz AT -7dBFS) (250MSPS)

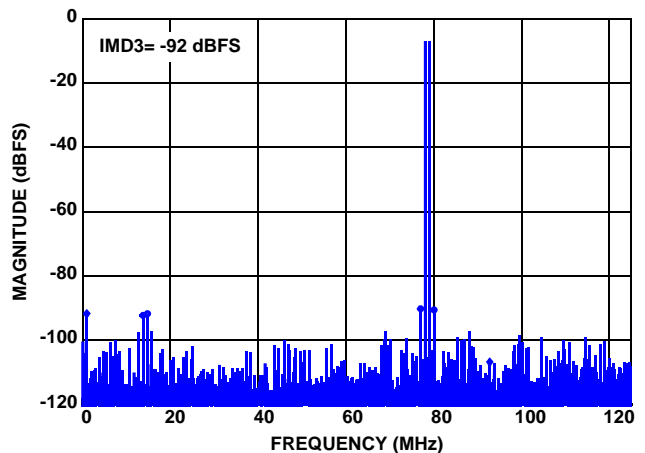

FIGURE 26. TWO-TONE SPECTRUM (F1 = 170MHz, F2 = 171MHz AT -7dBFS) (250MSPS)

## Typical Performance Curves

All Typical Performance Characteristics apply under the following conditions unless otherwise noted: AVDD = OVDD = 1.8V, T<sub>A</sub> = +25°C, A<sub>IN</sub> = -2dBFS, f<sub>IN</sub> = 105MHz, f<sub>SAMPLE</sub> = 250MSPS. (Continued)

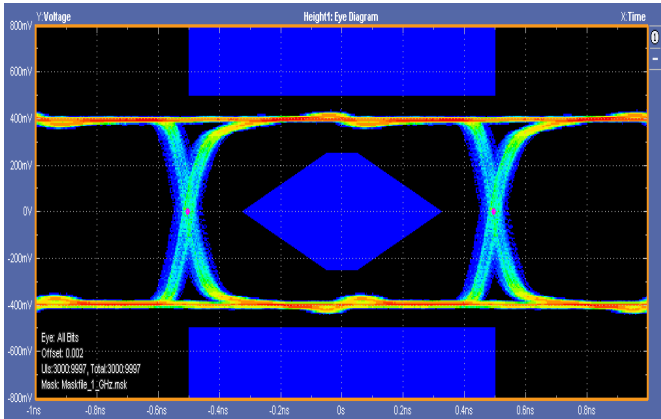

FIGURE 27. SERDES DATA EYE at 1.0Gbps

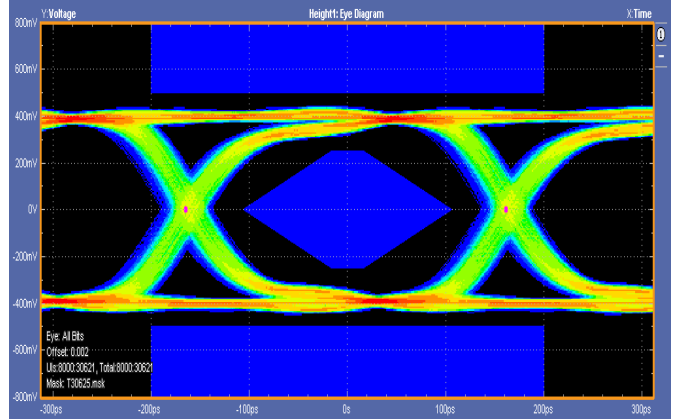

FIGURE 28. SERDES DATA EYE at 3.0Gbps

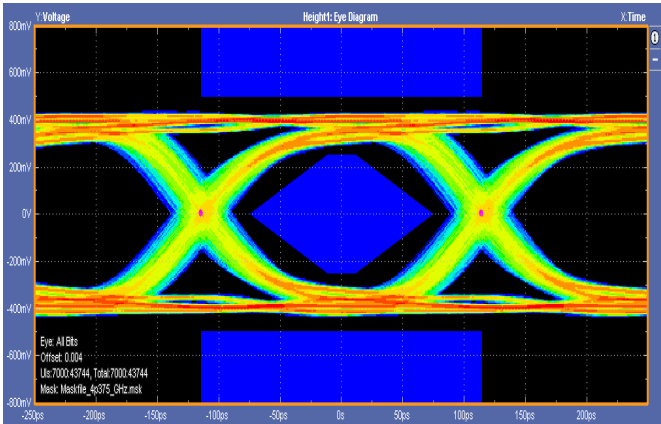

FIGURE 29. SERDES DATA EYE at 4.375Gbps

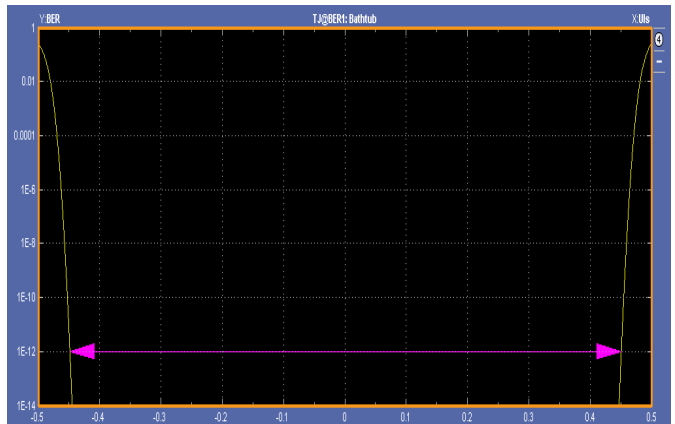

FIGURE 30. SERDES BATHTUB at 1.0Gbps

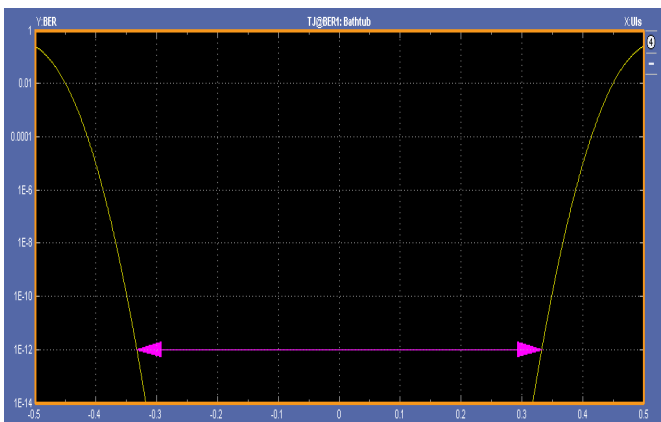

FIGURE 31. SERDES BATHTUB at 3.0Gbps

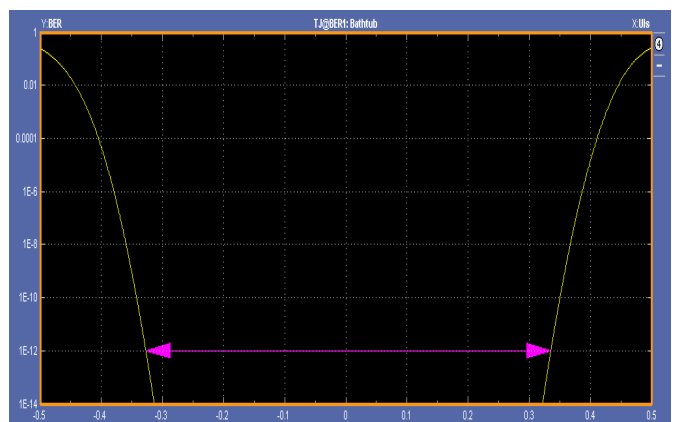

FIGURE 32. SERDES BATHTUB at 4.375Gbps

## Typical Performance Curves

All Typical Performance Characteristics apply under the following conditions unless otherwise noted: AVDD = OVDD = 1.8V, T<sub>A</sub> = +25 °C, A<sub>IN</sub> = -2dBFS, f<sub>IN</sub> = 105MHz, f<sub>SAMPLE</sub> = 250MSPS. (Continued)

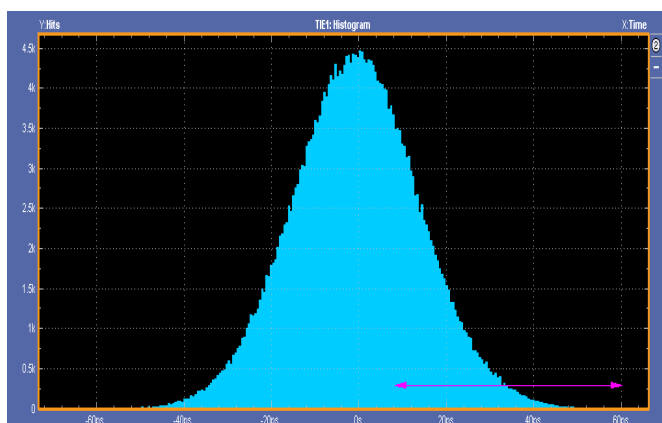

FIGURE 33. SERDES HISTOGRAM at 1.0Gbps

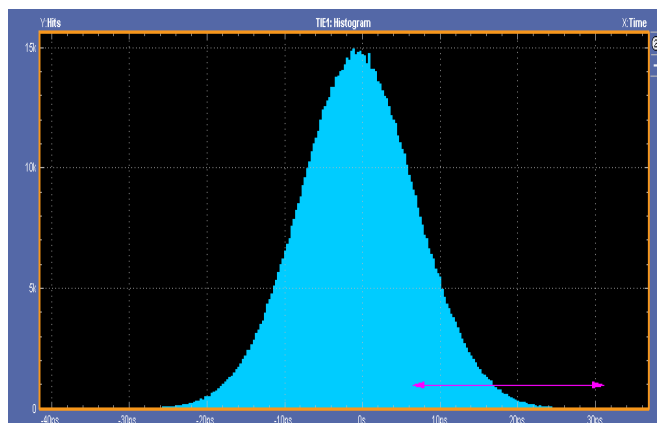

FIGURE 34. SERDES HISTOGRAM at 3.0Gbps

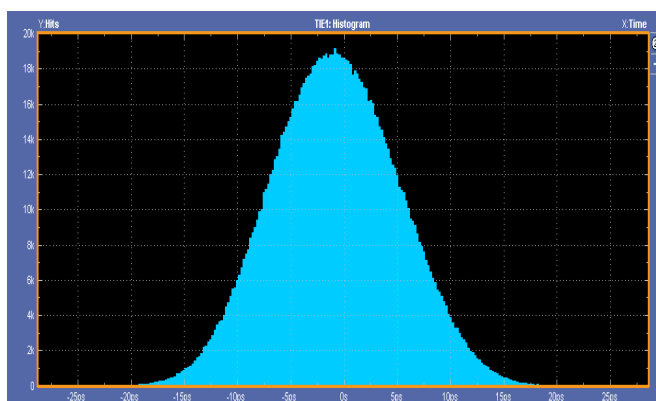

FIGURE 35. SERDES HISTOGRAM at 4.375Gbps

## Theory of Operation

### Functional Description

The ISLA222S is based upon a 12-bit, 250MSPS ADC converter core that utilizes a pipelined successive approximation architecture (see Figure 36). The input voltage is captured by a Sample-Hold Amplifier (SHA) and converted to a unit of charge. Proprietary charge-domain techniques are used to successively compare the input to a series of reference charges. Decisions made during the successive approximation operations determine the digital code for each input value. Digital error correction is also applied.

### Power-On Calibration

The ADC core(s) perform a self-calibration at start-up. An internal power-on-reset (POR) circuit detects the supply voltage ramps and initiates the calibration when the analog and digital supply

voltages are above a threshold. The following conditions must be adhered to for the power-on calibration to execute successfully:

- A frequency-stable conversion clock must be applied to the CLKP/CLKN pins
- DNC pins must not be connected
- SDO has an internal pull-up and should not be driven externally
- RESETN is pulled low by the ADC internally during POR. External driving of RESETN is optional.
- SPI communications must not be attempted during calibration, with the only exception of performing read operations on the cal\_done register at address 0xB6.

A user-initiated reset can subsequently be invoked in the event that the above conditions cannot be met at power-up.

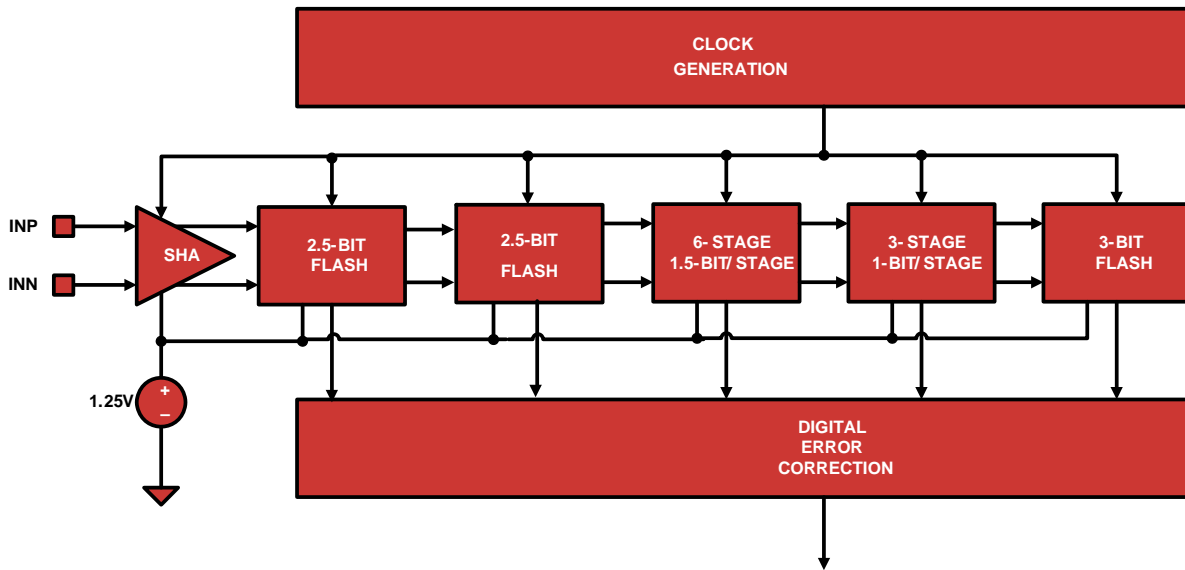

FIGURE 36. ADC CORE BLOCK DIAGRAM

After the power supply has stabilized, the internal POR releases RESETN and an internal pull-up pulls it high, which starts the calibration sequence. If a subsequent user-initiated reset is desired, the RESETN pin should be connected to an open-drain driver with an off-state/high impedance state leakage of less than 0.5mA to assure exit from the reset state so calibration can start.

The calibration sequence is initiated on the rising edge of RESETN, as shown in Figure 37. Calibration status can be determined by reading the cal\_status bit (LSB) at 0xB6. This bit is '0' during calibration and goes to a logic '1' when calibration is complete. During calibration the JESD204 transmitter PLL is not locked to the ADC sample clock, so the CML outputs will toggle at an undetermined rate. Normal operation is resumed once calibration is complete.

At 250MSPS the nominal calibration time is 280ms, while the maximum calibration time is 550ms.

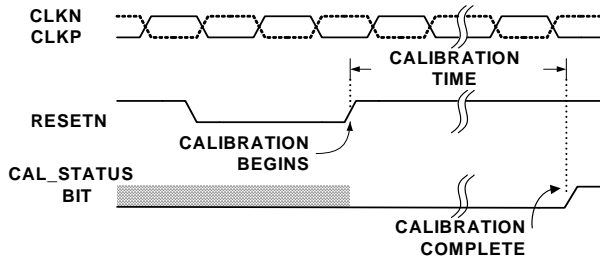

FIGURE 37. CALIBRATION TIMING

## User Initiated Reset

Recalibration of the ADC can be initiated at any time by driving the RESETN pin low for a minimum of one clock cycle. An open-drain driver with a drive strength in its high impedance state of less than 0.5mA is recommended, as RESETN has an internal high impedance pull-up to OVDD. As is the case during power-on reset, RESETN and DNC pins must be in the proper state for the calibration to successfully execute.

The performance of the ISLA222S changes with variations in temperature, supply voltage or sample rate. The extent of these changes may necessitate recalibration, depending on system performance requirements. Best performance will be achieved by recalibrating the ADC under the environmental conditions at which it will operate.

A supply voltage variation of <math><100\text{mV}</math> will generally result in an SNR change of <math><0.5\text{dBFS}</math> and SFDR change of <math><3\text{dBc}</math>. In situations where the sample rate is not constant, best results will be obtained if the device is calibrated at the highest sample rate. Reducing the sample rate by less than 80MSPS will typically result in an SNR change of <math><0.5\text{dBFS}</math> and an SFDR change of <math><3\text{dBc}</math>.

Figures 38 through 43 show the affect of temperature on SNR and SFDR performance with power on calibration performed at



# Temperature Calibration

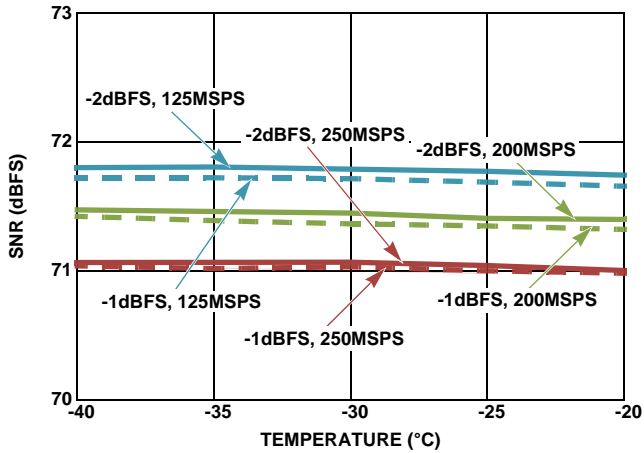

FIGURE 38. TYPICAL SNR PERFORMANCE vs TEMPERATURE, DEVICE CALIBRATED AT -40°C,  $f_{IN} = 105\text{MHz}$

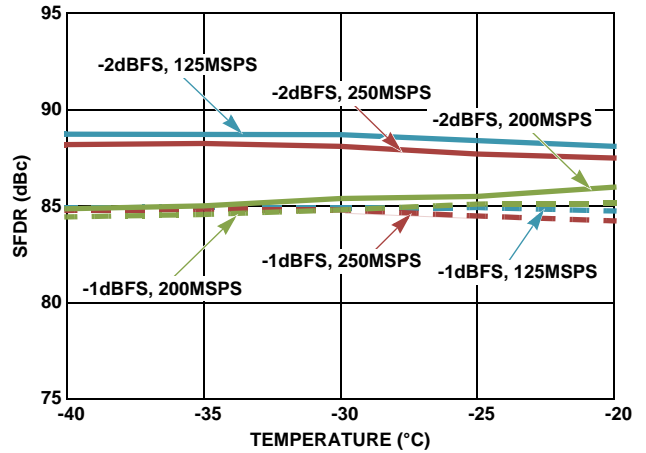

FIGURE 39. TYPICAL SFDR PERFORMANCE vs TEMPERATURE, DEVICE CALIBRATED AT -40°C,  $f_{IN} = 105\text{MHz}$

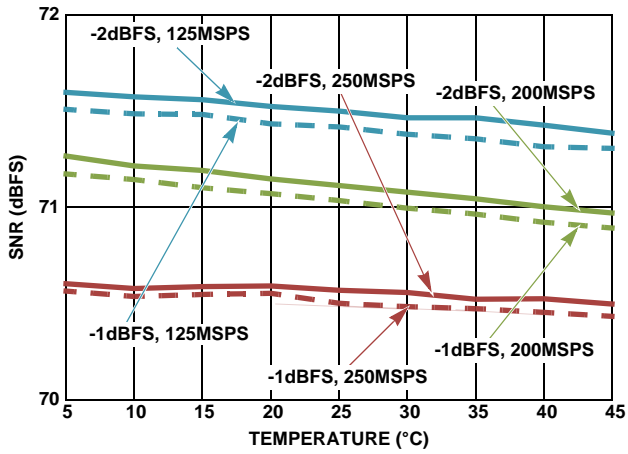

FIGURE 40. TYPICAL SNR PERFORMANCE vs TEMPERATURE, DEVICE CALIBRATED AT +25°C,  $f_{IN} = 105\text{MHz}$

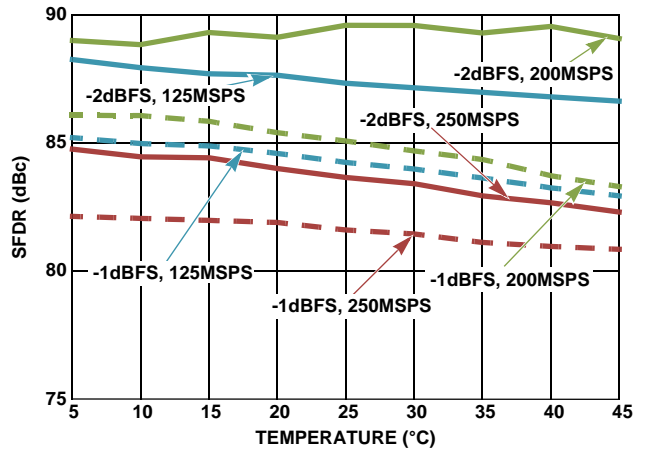

FIGURE 41. TYPICAL SFDR PERFORMANCE vs TEMPERATURE, DEVICE CALIBRATED AT +25°C,  $f_{IN} = 105\text{MHz}$

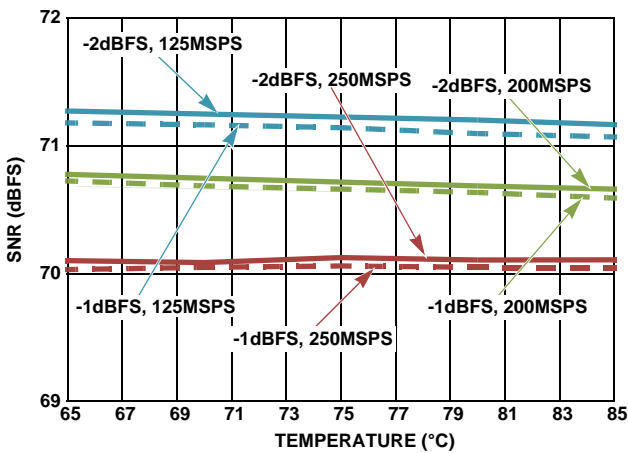

FIGURE 42. TYPICAL SNR PERFORMANCE vs TEMPERATURE, DEVICE CALIBRATED AT +85°C,  $f_{IN} = 105\text{MHz}$

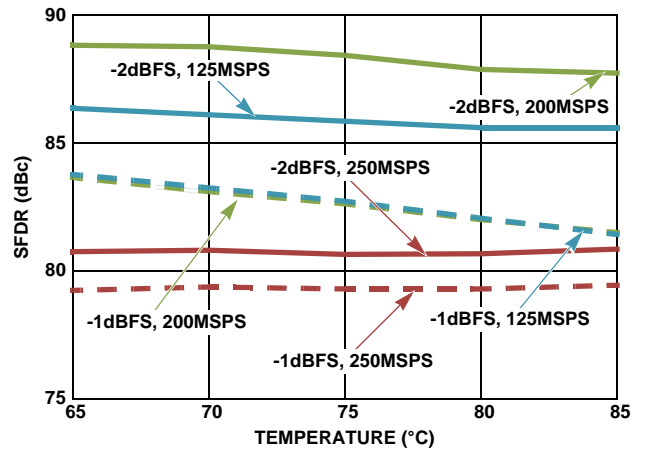

FIGURE 43. TYPICAL SFDR PERFORMANCE vs TEMPERATURE, DEVICE CALIBRATED AT +85°C,  $f_{IN} = 105\text{MHz}$

## Analog Input

A single fully differential input (VINP/VINN) connects to the sample and hold amplifier (SHA) of each unit ADC. The ideal full-scale input voltage is 2.0V, centered at the VCM voltage as shown in Figure 44.

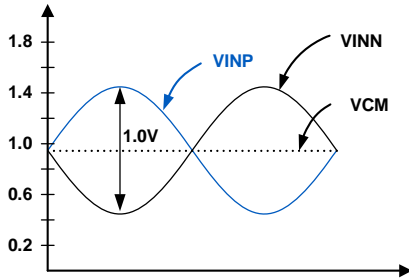

FIGURE 44. ANALOG INPUT RANGE

Best performance is obtained when the analog inputs are driven differentially. The common-mode output voltage, VCM, should be used to properly bias the inputs as shown in Figures 45 through 47. An RF transformer will give the best noise and distortion performance for wideband and/or high intermediate frequency (IF) inputs. Two different transformer input schemes are shown in Figures 45 and 46.

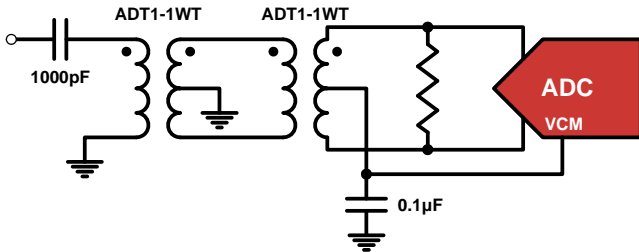

FIGURE 45. TRANSFORMER INPUT FOR GENERAL PURPOSE APPLICATIONS

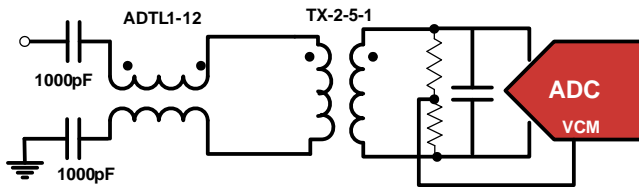

FIGURE 46. TRANSMISSION-LINE TRANSFORMER INPUT FOR HIGH IF APPLICATIONS

This dual transformer scheme is used to improve common-mode rejection, which keeps the common-mode level of the input matched to VCM. The value of the shunt resistor should be determined based on the desired load impedance. The differential input resistance of the ISLA222S is 600Ω.

The SHA design uses a switched capacitor input stage (see Figure 60 on page 37), which creates current spikes when the sampling capacitance is reconnected to the input voltage. This causes a disturbance at the input, which must settle before the next sampling point. Lower source impedance will result in faster settling and improved performance. Therefore a 2:1 or 1:1 transformer and low shunt resistance are recommended for optimal performance.

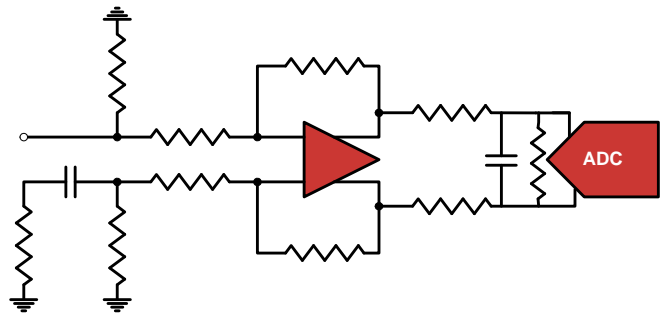

FIGURE 47. DIFFERENTIAL AMPLIFIER INPUT

A differential amplifier, as shown in the simplified block diagram in Figure 47, can be used in applications that require DC-coupling. In this configuration, the amplifier will typically dominate the achievable SNR and distortion performance. Intersil's new ISL552xx differential amplifier family can also be used in certain AC applications with minimal performance degradation. Contact [Intersil sales support](#) with your needs.

When an over range occurs, the data sample output bits are held at full scale (all 0's or all 1's), thus allowing the detection of this condition in the receiver device.

## Clock Input

The clock input circuit is a differential pair (see Figure 61 on page 37). Driving these inputs with a high level (up to 1.8V<sub>P-P</sub> on each input) sine or square wave will provide the lowest jitter performance. A transformer with 4:1 impedance ratio will provide increased drive levels. The clock input is functional with AC-coupled LVDS, LVPECL, and CML drive levels. To maintain the lowest possible aperture jitter, it is recommended to have high slew rate at the zero crossing of the differential clock input signal.

The recommended drive circuit is shown in Figure 48. A duty range of 40% to 60% is acceptable. The clock can be driven single-ended, but this will reduce the edge rate and may impact SNR performance. The clock inputs are internally self-biased to AV<sub>DD</sub>/2 through a Thevenin equivalent of 10kΩ to facilitate AC coupling.

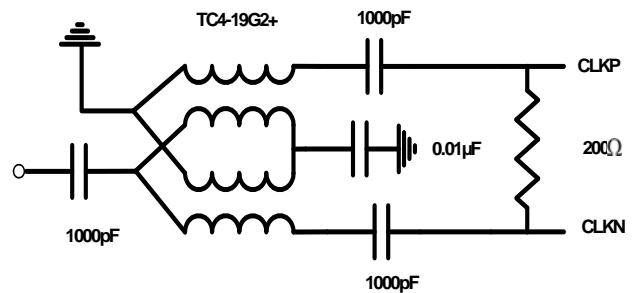

FIGURE 48. RECOMMENDED CLOCK DRIVE

A selectable 2x or 4x frequency divider is provided in series with the clock input. The divider can be used in the 2x mode with a sample clock equal to twice the desired sample rate or in 4x mode with a sample clock equal to four times the desired sample rate. Use of the 2x or 4x frequency divider enables the use of the Phase Slip feature, which enables the system to be able to select the phase of the

divide by 2 or divide by 4 that causes the ADC to sample the analog input.

**TABLE 1. CLKDIV PIN SETTINGS**

CLKDIV PIN	DIVIDE RATIO
AVSS	2
Float	1
AVDD	4

The clock divider can also be controlled through the SPI port, which overrides the CLKDIV pin setting. See “SPI Physical Interface” on page 27. A delay-locked loop (DLL) generates internal clock signals for various stages within the charge pipeline. If the frequency of the input clock changes, the DLL may take up to 52µs to regain lock at 250MSPS. The lock time is inversely proportional to the sample rate.

The DLL has two ranges of operation, slow and fast. The slow range can be used for ADC core sample rates between 40MSPS and 100MSPS, while the default fast range can be used from 80MSPS to the maximum specified sample rate. The lane data rate is related to the ADC core sample rate by a relationship that is defined by the JESD204 transmitter configuration, and has additional frequency constraints; see “JESD204 Transmitter” on page 20 for additional details.

## Jitter

In a sampled data system, clock jitter directly impacts the achievable SNR performance. The theoretical relationship between clock jitter ( $t_j$ ) and SNR is shown in Equation 1 and is illustrated in Figure 49.

$$\text{SNR} = 20 \log_{10} \left( \frac{1}{2\pi f_{IN} t_j} \right) \quad (\text{EQ. 1})$$

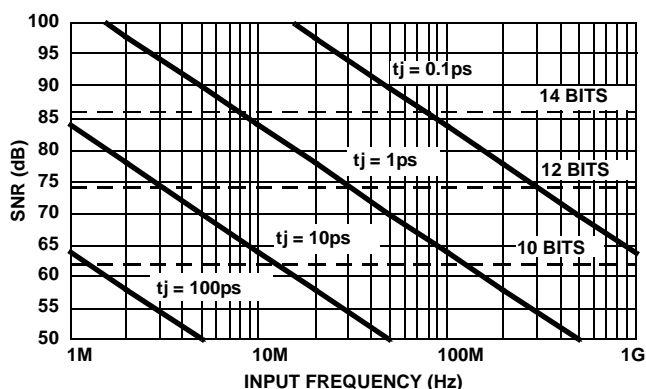

**FIGURE 49. SNR vs CLOCK JITTER**

This relationship shows the SNR that would be achieved if clock jitter were the only non-ideal factor. In reality, achievable SNR is limited by internal factors such as linearity, aperture jitter and thermal noise as well. Internal aperture jitter is the uncertainty in the sampling instant. The internal aperture jitter combines with the input clock jitter in a root-sum-square fashion, since they are not statistically correlated, and this determines the total jitter in the system. The total jitter, combined with other noise sources, then determines the achievable SNR.

## Voltage Reference

A temperature compensated internal voltage reference provides the reference charges used in the successive approximation operations. The full-scale range of each ADC is proportional to the reference voltage. The nominal value of the voltage reference is 1.25V.

## Digital Outputs

The digital outputs are in CML format, and feature analog and digital characteristics compliant with the JESD204 standard requirements.

## Power Dissipation

The power dissipated by the device is dependent on the ADC sample rate and the number of active lanes in the link. There is a fixed bias current drawn from the analog supply for the ADC, along with a fixed bias current drawn from the digital supply for each active lane. The remaining power dissipation is linearly related to the sample rate.

## Nap/Sleep

Portions of the device may be shut down to save power during times when operation of the ADC is not required. Two power saving modes are available: Nap, and Sleep. Nap mode reduces power dissipation significantly while taking a very short time to return to functionality. Sleep mode reduces power consumption drastically while taking longer to return to functionality.

In Nap mode the JESD204 lanes will continue to produce valid encoded data, allowing the link to remain active and thus return to a functional state quickly. The data transmitted over the lanes in nap mode is the last valid ADC sample, repeated until leaving nap mode. The 8b/10b encoder's running disparity will prevent the potentially long time repetition of this last valid sample from creating DC bias on the lane. In sleep mode, the JESD204 lanes will be deactivated to conserve power. Thus, sometime after wake up code group alignment will be required to reestablish the link.

The input clock should remain running and at a fixed frequency during Nap or Sleep, and CSB should be high. The JESD204 link will only remain established during nap mode if the input clock continues to remain stable during the nap period.

By default after the device is powered on, the operational state is controlled by the NAPSLP pin as shown in Table 2. Please note that power on calibration occurs at power-up time regardless of the state of the NAPSLP pin; immediately following this power on calibration routine, the device will enter nap or sleep state if the NAPSLP pin voltage dictates it is to do so.

**TABLE 2. NAPSLP PIN SETTINGS**

NAPSLP PIN	MODE
AVSS	Normal
Float	Nap
AVDD	Sleep

The power-down mode can also be controlled through the SPI port, which overrides the NAPSLP pin setting. Details on this are contained in “Serial Peripheral Interface” on page 27.

## Data Format

Output data can be presented in three formats: two's complement (default), Gray code and offset binary. The data format can be controlled through the SPI port by writing to address 0x73. Details on this are contained in "Serial Peripheral Interface" on page 27.

Offset binary coding maps the most negative input voltage to code 0x000 (all zeros) and the most positive input to 0xFF (all ones). Two's complement coding simply complements the MSB of the offset binary representation.

When calculating Gray code the MSB is unchanged. The remaining bits are computed as the XOR of the current bit position and the next most significant bit. Figure 50 shows this operation.

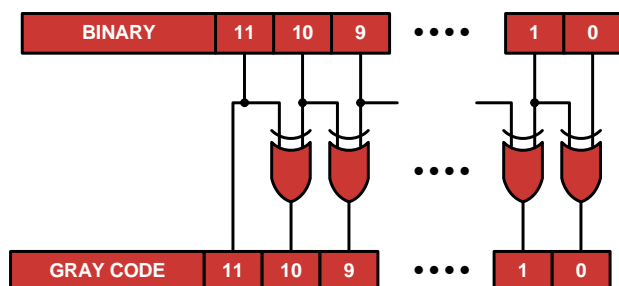

FIGURE 50. BINARY TO GRAY CODE CONVERSION

Converting back to offset binary from Gray code must be done recursively, using the result of each bit for the next lower bit as shown in Figure 51.

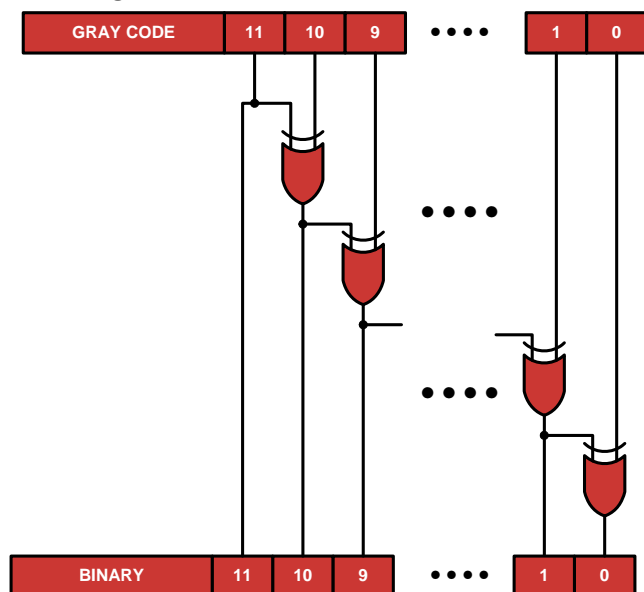

FIGURE 51. GRAY CODE TO BINARY CONVERSION

Mapping of the input voltage to the various data formats is shown in Table 3.

TABLE 3. INPUT VOLTAGE TO OUTPUT CODE MAPPING

INPUT VOLTAGE	OFFSET BINARY	TWO'S COMPLEMENT	GRAY CODE
-Full Scale	0000 0000 0000	1000 0000 0000	0000 0000 0000
-Full Scale + 1LSB	0000 0000 0001	1000 0000 0001	0000 0000 0001
Mid-Scale	1000 0000 0000	0000 0000 0000	1100 0000 0000
+Full Scale - 1LSB	1111 1111 1110	0111 1111 1110	1000 0000 0001
+Full Scale	1111 1111 1111	0111 1111 1111	1000 0000 0000

## Clock Divider Synchronous Reset

The function of clock divider synchronous reset is available as a SPI-programmable overloaded function on the SYNCN and SYNCP pins. Given that the clock divider reset and SYNC features have the same electrical and timing requirements, this overloading allows the system to generate only a single well timed signal with respect to the ADC sample clock and select the ADC's interpretation of the signal as a SPI-programmable option (see SPI register 0x77 description for more information). By default the SYNCP and SYNCN pins will function as the JESD204 SYNC~.

The use of clock divider reset function is a requirement in a system that uses the ISLA214S50, ISLA214S35, or CLKDIV = 2 or 4 and also requires time alignment or deterministic latency of multiple devices. Please contact [Intersil sales support](#) with your needs about this feature and its usage.

## Soft Reset

Soft reset is a function intended to be used when the power on reset is to be re-run. An application may decide to issue a soft calibration command after significant temperature change or after a change in the sample rate frequency to optimize performance under the new condition.

Soft reset is issued by writing the Soft Reset bit at SPI address 0x00. Soft reset is a self-resetting bit in that will automatically return to 0 once the power on calibration has completed.

## JESD204 Transmitter

### Overview

The conversion data is presented by a JESD204B-compliant SERDES interface. The SERDES lane data rate supports typical speeds up to 4.375Gbps, exceeding the 3.125Gbps maximum specified by the JESD204 rev A standard. Two packing modes are supported: Efficient and Simple. A SYNC input is included, which is used for lane initialization as well as time alignment of multiple converter devices. AC coupling of the SERDES lane(s) on the board is required. A block diagram of this SERDES transmitter is shown in Figure 52.

For more information about the standardized characteristics and features of a JESD204 interface, please see JESD204 rev A and rev B standards. For application design support, including evaluation kit schematics and layout, reference FPGA project(s), and simulation models for functionality and signal integrity, please contact [Intersil sales support](#) with your needs and/or view application notes on the Intersil website.

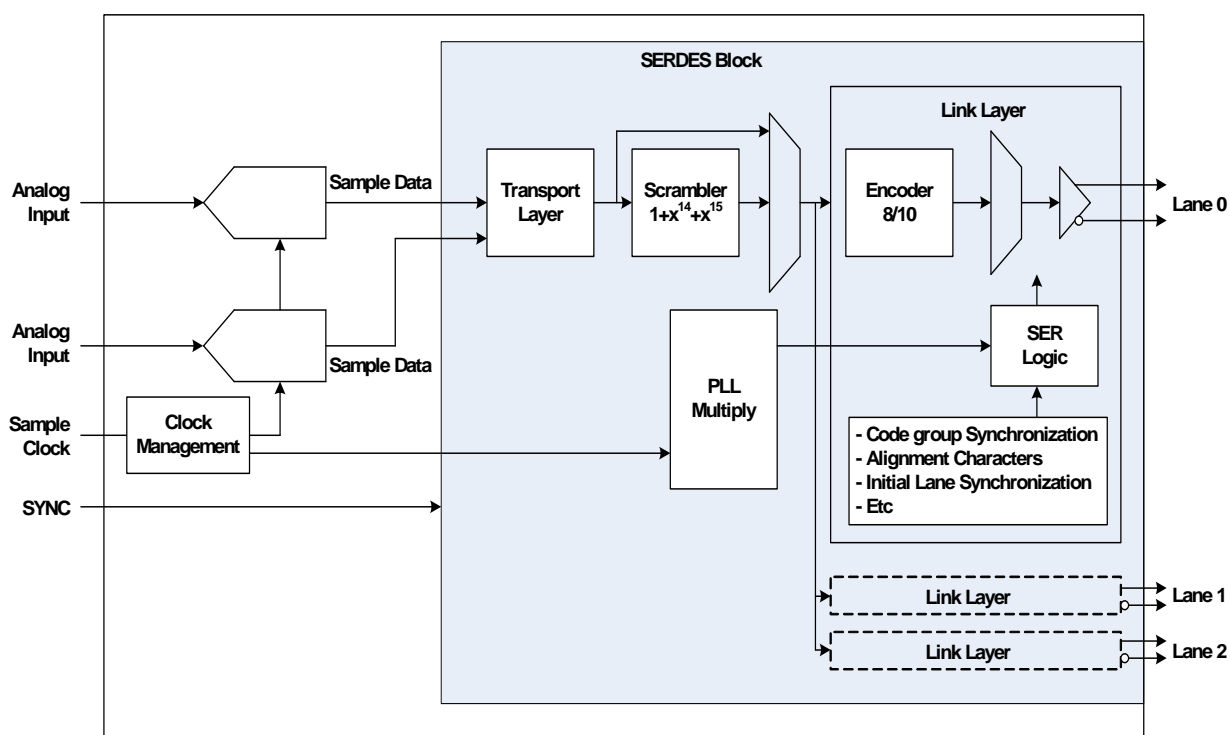

FIGURE 52. SERDES TRANSMITTER BLOCK DIAGRAM

To maximize flexibility at the system level, two transport layer packing modes are supported: simple and efficient. These two modes allow the system designer flexibility to trade off between the number of lanes to support a given throughput, the data rate of these lanes, and the complexity of the receiver. This translates directly into providing system level trade-offs between cost, power, and resource usage of the receiver and complexity of the solution.

*Simple* mode packs informationless bits onto each ADC sample to form full 16-bit data. In simple mode packing, the frame clock and ADC sample clock are the same frequency, easing frequency scaling requirements at the system level, but decreasing the payload efficiency of the lanes. Decreased payload efficiency of the lanes increases the lane data rate required to support a given throughput, and may require additional lanes to support a given configuration. The degree of payload efficiency loss is dependent on the ADC resolution.

*Efficient* mode packs sequential ADC samples into a contiguous block of an integer number of octets, and then slices the block into the octets for transport. This mode always achieves the theoretical maximum payload of the lanes (80%) regardless of the resolution of the ADC and the number of lanes used. This mode provides the minimum number of lanes at the minimum data rate that is theoretically possible given the 8b/10b encoding used in JESD204 systems. In efficient packing mode, frame clock and the ADC sample clock have an M/N relationship, where M and N are small integers and vary depending on the ADC resolution and number of lanes selected. Efficient mode packing may require additional frequency scaling elements (internal FPGA PLLs or discrete frequency scaling devices) to generate the frame clock for the receiving device.

The default configuration for this device is efficient packing mode. Reconfiguration into the simple packing mode is accomplished by programming the JESD204 parameters via the SPI bus. See Table 5 for the full list of parameters values for each mode and product. Via SPI, the JESD204 transmitter is highly configurable, supporting efficient to simple mode packing reconfiguration as well as “downgrading” a given product’s JESD204 interface. For example, reconfiguring a 3-lane product into 2 lanes (with each running faster than with 3 lanes), or reducing the resolution of the ADC(s) to slow down the lane data rate in systems where the full ADC resolution is not required, are supported. Please contact [Intersil sales support](#) for a full list of downgradeable configurations that are supported.

Signal integrity plots, including data eye, BER bathtub curves, and edge histogram plots versus lane data rate can be found in the “Typical Performance Curves” beginning on page 10.

### Initial Lane Alignment

The link initialization process is started by asserting the SYNC~ signal to the ADC device. This assertion causes the JESD204 transmitter to generate comma characters, which are used by the receiver to accomplish code group synchronization (bit and octet alignment, respectively). Once code group synchronization is detected in the receiver, it de-asserts the SYNC~ signal, causing the JESD204 transmitter to generate the initial lane alignment sequence (ILA). The ILA is comprised of 4 multi-frames of data in a standard format, with the length of each multi-frame determined by the K parameter as programmed into the SPI JESD204 parameter table. The ILA includes standard control character markers that can be used to perform channel bonding in the receiving device if desired. The 2nd multi-frame includes the full JESD204 parameter

data, allowing the receiver to auto-detect the lane configuration if desired.

After completion of the ILA the JESD204 transmitter begins transmitting ADC sample data. Continuous link and lane alignment monitoring is accomplished via an octet substitution scheme. The last octet in each frame, if identical to the last octet in the previous frame, is replaced with a specific control character. If both sides of the link support lane synchronization, the last octet in each multi-frame, if identical to the last octet in the previous frame, is replaced with a different specific control character. A more complete description of the link initialization sequence, including finite state machine implementation, can be found in the JESD204 rev A standard.

## LANE DATA RATE

The lane data rate for this product family is a function of the ADC sample rate, the number of SERDES lanes used, and packing mode selected in the SERDES transmitter. Figure 53 illustrates the relationship between ADC sample rate and SERDES lane rate for various transmitter configurations. The SERDES can typically operate from lane rates of 1 to over 4.375Gbps. For each ADC speed grade, the SERDES lanes are tested at its maximum ADC sample rate using three lane efficient packing as well as two-lane, efficient packing for the 250 and 200MSPS speed versions and one-lane, efficient packing for 125MSPS speed version.

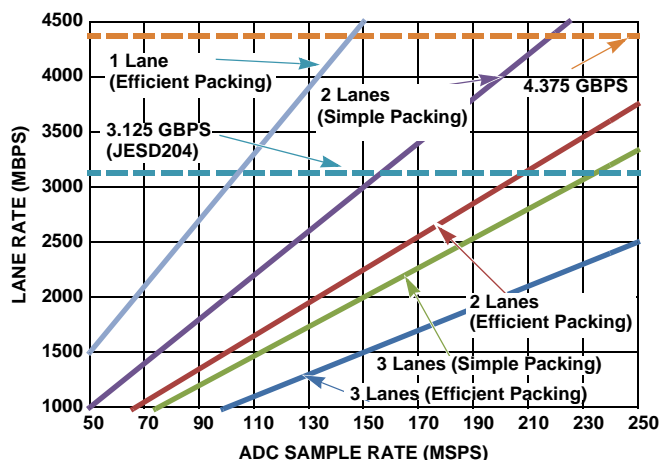

FIGURE 53. LANE DATA RATE AS A FUNCTION OF ADC SAMPLE RATE, PACKING

## SCRAMBLER

The bypassable scrambler is compliant with the scrambler defined in the JESD204 rev A standard.

This implementation seeds the scrambler with the initial lane alignment sequence, such that the first two octets following the sequence can be properly descrambled if the receiver also

passes the lane alignment sequence through its descrambler. Even if the receiver does not implement this detail, the 3rd and subsequent octets can be descrambled to yield ADC data due to the self-synchronizing nature of the scrambler used.

## MULTI-CHIP TIME ALIGNMENT

The JESD204 standard (in various revisions) provides the capability to time align multiple JESD204 ADC devices to a single logic device (FPGA or ASIC). This feature is critical in many applications that cannot tolerate the variable latency of the JESD204 link, and that must process pipeline depth correct data from more than one ADC device.

Time alignment of multiple devices provides the capability to align samples from multiple JESD204 ADC devices in the system in a pipeline-depth correct manner, thus enabling the system to analyze the ADC data from multiple devices while eliminating the variable latency of the JESD204 link as a concern. This capability enables configurations of JESD204 ADCs as IQ, interleave, and/or simultaneously-sampled converters.

This ADC family uses the asserted to de-asserted SYNC~ transition as the absolute time event with which to generate a known sequence of characters at the JESD204 transmitter of equal pipeline depth between all ADC devices in the system to be time aligned. This is consistent with the JESD204 rev B subclass 2 device definition.

## Test Patterns

The complexity of the JESD204 interface merits much more test pattern capability than less complex parallel interfaces. This device family consequently supports a much wider range of test patterns than previous ADC families.

Supported test patterns include both transport and link layer patterns. Transport layer patterns are passed through the transport layer of the JESD204 transmitter, following the same sequence of being packed and sliced into octets as the ADC sample data. Link layer test patterns bypass the transport layer and are injected directly into the 8b/10b encoder, serialized, and sent out of the physical media. Test pattern generation is controlled through SPI register 0xCO.

Link layer PRBS patterns are standard PRBS patterns that can be used with built-in standard PRBS checkers in, for example, FPGA SERDES-capable pins.

All transport layer test patterns re-initialize their phase when the SYNC~ de-assertion occurs; consequently, a system that provides a well-timed SYNC~ signal with respect to the ADC sample clock can expect transport layer test patterns to have consistent phase with respect to that de-assertion, which can be a significant aid when debugging the system.

# ISLA222S

**TABLE 4. JESD204 CONFIGURATIONS AND CLOCK FREQUENCIES**

ADC SAMPLE CLOCK RANGE (MHz)	LANE DATA RATE MULTIPLIER FROM ADC SAMPLE CLOCK RATE	LANE DATA RATE (GBPS)
100-250 (Efficient Packing) 3 Lanes	$(12\text{-bits}) * (2 \text{ ADC channels}) * (10/8 \text{ encoder overhead}) / (3 \text{ lanes}) = (240/24) = 10.0$	1.00 to 2.50
66.67-250 (Efficient Packing) 2 Lanes	$(12\text{-bits}) * (2 \text{ ADC channels}) * (10/8 \text{ encoder overhead}) / (2 \text{ lanes}) = (240/16) = 15$	1.00 to 3.75
50-218.75(Simple Packing) 2 Lanes	$(12\text{-bits}+4\text{-bit tail}) * (2 \text{ ADC channels}) * (10/8 \text{ encoder overhead}) / (2 \text{ lanes}) = (320/16) = 20$	1.00 to 4.375
40-145.8 (Efficient Packing) 1 Lane	$(12\text{-bits}) * (2 \text{ ADC channels}) * (10/8 \text{ encoder overhead}) / (1 \text{ lane}) = (240/8) = 30$	1.20 to 4.375
40-109.375(Simple Packing) 1 Lane	$(12\text{-bits}+4\text{-bit tail}) * (2 \text{ ADC channels}) * (10/8 \text{ encoder overhead}) / (1 \text{ lane}) = (320/8) = 40$	1.60 to 4.375

**TABLE 5. JESD204 PARAMETERS**

PACKING MODE	NUMBER OF LANES	JESD204 PARAMETER	ENCODED	JESD204 PARAMETERS AND FRAME MAP (Notes 16, 17, 18)									
Efficient	3	CF = 0	0										
		CS = 0	0	COS0[11:4]	COS0[3:0]	COS1[7:0]	COS2[11:4]	COS2[3:0]	COS3[7:0]				
		F = 6	5		COS1[11:8]			COS3[11:8]					
		HD = 0	0										
		L = 3	2	COS4[11:4]	COS4[3:0]	COS5[7:0]	C1S0[11:4]	C1S0[3:0]	C1S1[7:0]				
		M = 2	1		COS5[11:8]			C1S1[11:8]					
		N = 12	11										
		N' = 12	11	C1S2[11:4]	C1S2[3:0]	C1S3[7:0]	C1S4[11:4]	C1S4[3:0]	C1S5[7:0]				
		S = 6	5		C1S3[11:8]			C1S5[11:8]					
		K >= 3	>= 2										
Efficient	2	CF = 0	0										
		CS = 0	0	COS0[11:4]	COS0[3:0]	COS1[7:0]							
		F = 3	2		COS1[11:8]								
		HD = 0	0										
		L = 2	1	C1S0[11:4]	C1S0[3:0]	C1S1[7:0]							
		M = 2	1		C1S1[11:8]								
		N = 12	11										
		N' = 12	11										
		S = 2	1										
		K >= 6	>=5										

# ISLA222S

TABLE 5. JESD204 PARAMETERS (Continued)

PACKING MODE	NUMBER OF LANES	JESD204 PARAMETER	ENCODED	JESD204 PARAMETERS AND FRAME MAP (Notes 16, 17, 18)									
Simple	2	CF = 0	0										
		CS = 0	0	COS0[11:4]	COS0[3:0]								
		F = 2	1		TTTT								
		HD = 0	0										
		L = 2	1	C1S0[11:4]	C1S0[3:0]								
		M = 2	1		TTTT								
		N = 12	11										
		N' = 16	15										
		S = 1	0										
K >= 9	>= 8												
Efficient	1	CF = 0	0										
		CS = 0	0	COS0[11:4]	COS0[3:0]	COS1[7:0]	C1S0[11:4]	C1S0[3:0]	C1S1[7:0]				
		F = 6	5		COS1[11:8]			C1S1[11:8]					
		HD = 0	0										
		L = 1	0										
		M = 2	1										
		N = 12	11										
		N' = 12	11										
		S = 2	1										
		K >= 3	>= 2										
Simple	1	CF = 0	0										
		CS = 0	0	COS0[11:4]	COS0[3:0]	C1S0[11:4]	C1S0[3:0]						
		F = 4	3		TTTT		TTTT						
		HD = 0	0										
		L = 1	0										
		M = 2	1										
		N = 12	11										
		N' = 16	15										
		S = 1	0										
K >= 5	>= 4												

NOTES:

- The JESD204 parameters are shown as their actual values, with the JESD204 encoded values (i.e., the values that are programmed into the SPI registers) in the next column over. Typically values that must always be greater than 1 are encoded as value minus 1, and so on.
- Frame map format decoder: "CxSy[a:b]" = Converter x, Sample y, bits a through b. For example, "COS0[13:6]" = Converter 0, Sample 0, bits 13 through 6, etc. "T" = Tail bit (information-less bit packed in the transport layer mapping to form octets).
- The topmost lane in the graphical frame map is Lane0, followed by Lane1 and Lane 2 (for 3-lane configurations).



# ISLA222S

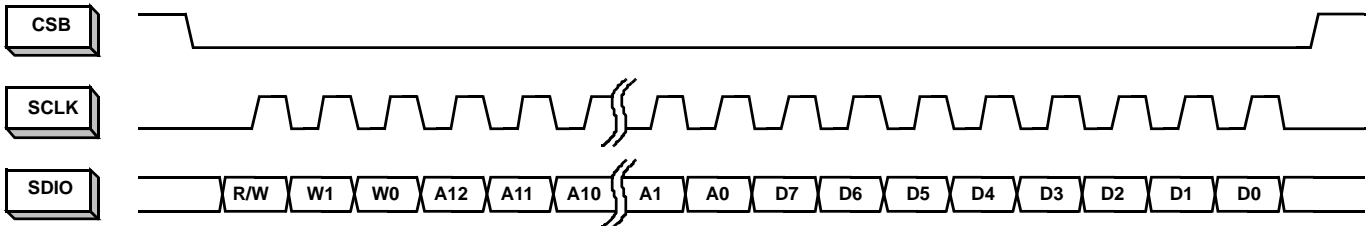

FIGURE 54. MSB-FIRST ADDRESSING

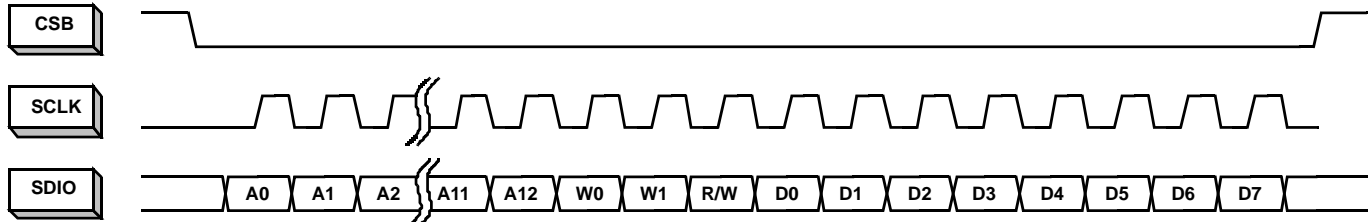
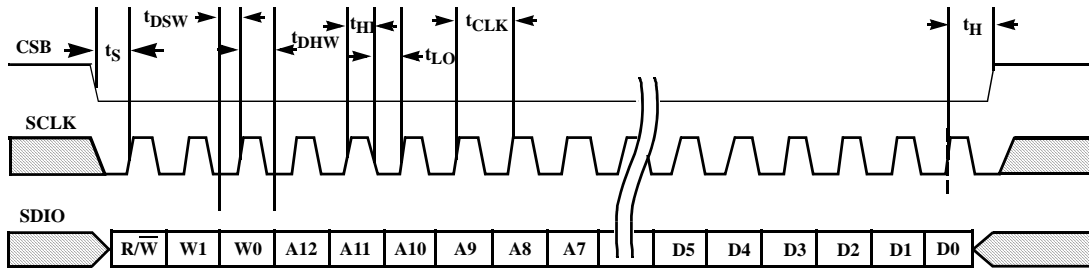
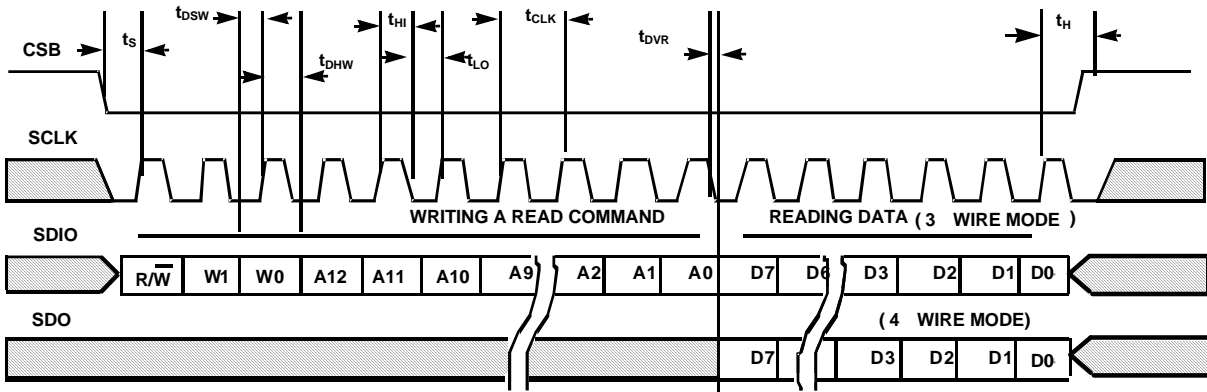

FIGURE 55. LSB-FIRST ADDRESSING



SPI WRITE

FIGURE 56. SPI WRITE



SPI READ

FIGURE 57. SPI READ

# ISLA222S

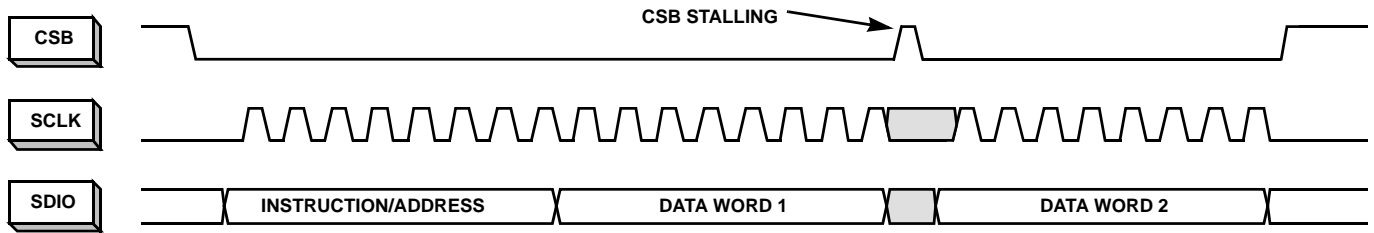

FIGURE 58. 2-BYTE TRANSFER

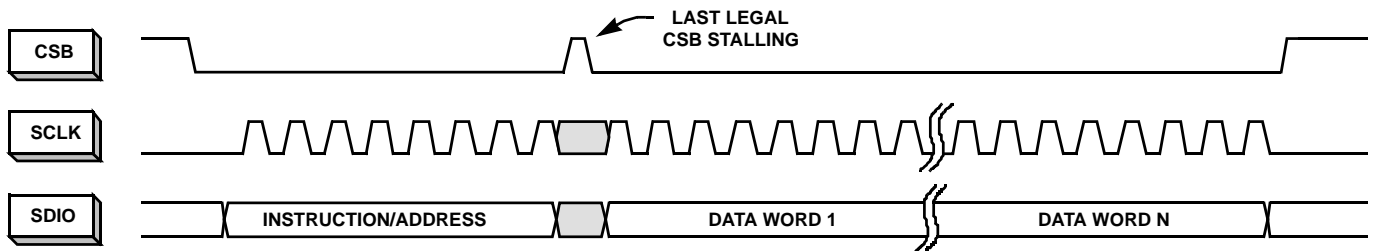

FIGURE 59. N-BYTE TRANSFER

## Serial Peripheral Interface

A serial peripheral interface (SPI) bus is used to facilitate configuration of the device and to optimize performance. The SPI bus consists of chip select (CSB), serial clock (SCLK) serial data output (SDO), and serial data input/output (SDIO). The maximum SCLK rate is equal to the ADC sample rate ( $f_{\text{SAMPLE}}$ ) divided by 7 for write operations and  $f_{\text{SAMPLE}}$  divided by 16 for reads. There is no minimum SCLK rate.

The following sections describe various registers that are used to configure the SPI or adjust performance or functional parameters. Many registers in the available address space (0x00 to 0xFF) are not defined in this document. Additionally, within a defined register there may be certain bits or bit combinations that are reserved. Undefined registers and undefined values within defined registers are reserved and should not be selected. Setting any reserved register or value may produce indeterminate results.

### SPI Physical Interface

The serial clock pin (SCLK) provides synchronization for the data transfer. By default, all data is presented on the serial data input/output (SDIO) pin in three-wire mode. The state of the SDIO pin is set automatically in the communication protocol (described in the following). A dedicated serial data output pin (SDO) can be activated by setting 0x00[7] high to allow operation in four-wire mode.

The SPI port operates in a half duplex master/slave configuration, with the ADC functioning as a slave. Multiple slave devices can interface to a single master in three-wire mode only, since the SDO output of an unaddressed device is asserted in four wire mode.

The chip-select bar (CSB) pin determines when a slave device is being addressed. Multiple slave devices can be written to concurrently, but only one slave device can be read from at a given time (again, only in three-wire mode). If multiple slave devices are selected for reading at the same time, the results will be indeterminate.

The communication protocol begins with an instruction/address phase. The first rising SCLK edge following a high-to-low transition on CSB determines the beginning of the two-byte instruction/address command; SCLK must be static low before the CSB transition. Data can be presented in MSB-first order or LSB-first order. The default is MSB-first, but this can be changed by setting 0x00[6] high. Figures 54 and 55 show the appropriate bit ordering for the MSB-first and LSB-first modes, respectively. In MSB-first mode, the address is incremented for multi-byte transfers, while in LSB-first mode it's decremented.

In the default mode, the MSB is R/W, which determines if the data is to be read (active high) or written. The next two bits, W1 and W0, determine the number of data bytes to be read or written (see Table 6). The lower 13 bits contain the first address for the data transfer. This relationship is illustrated in Figure 56, and timing values are given in "Switching Specifications" on page 8.

After the instruction/address bytes have been read, the appropriate number of data bytes are written to or read from the ADC (based on the R/W bit status). The data transfer will continue as long as CSB remains low and SCLK is active. Stalling of the CSB pin is allowed at any byte boundary (instruction/address or data) if the number of bytes being transferred is three or less. For transfers of four bytes or more, CSB is allowed to stall in the middle of the instruction/address bytes or before the first data byte. If CSB transitions to a high state after that point the state machine will reset and terminate the data transfer.

TABLE 6. BYTE TRANSFER SELECTION

[W1:W0]	BYTES TRANSFERRED
00	1
01	2
10	3
11	4 or more

Figures 58 and 59 illustrate the timing relationships for 2-byte and N-byte transfers, respectively. The operation for a 3-byte transfer can be inferred from these diagrams.

### SPI Configuration

#### ADDRESS 0X00: CHIP\_PORT\_CONFIG

Bit ordering and SPI reset are controlled by this register. Bit order can be selected as MSB to LSB (MSB first) or LSB to MSB (LSB first) to accommodate various micro controllers.

#### Bit 7 SDO Active

#### Bit 6 LSB First

Setting this bit high configures the SPI to interpret serial data as arriving in LSB to MSB order.

#### Bit 5 Soft Reset

Setting this bit high resets all SPI registers to default values.

#### Bit 4 Reserved

This bit should always be set high.

**Bits 3:0** These bits should always mirror bits 4:7 to avoid ambiguity in bit ordering.

#### ADDRESS 0X02: BURST\_END

If a series of sequential registers are to be set, burst mode can improve throughput by eliminating redundant addressing. The burst is ended by pulling the CSB pin high. Setting the burst\_end address determines the end of the transfer. During a write operation, the user must be cautious to transmit the correct number of bytes based on the starting and ending addresses.

#### Bits 7:0 Burst End Address

This register value determines the ending address of the burst data.

## Device Information

### ADDRESS 0X08: CHIP\_ID

### ADDRESS 0X09: CHIP\_VERSION

The generic die identifier and a revision number, respectively, can be read from these two registers.

## Device Configuration/Control

A common SPI map, which can accommodate single-channel or multi-channel devices, is used for all Intersil ADC products.

### ADDRESS 0X20: OFFSET\_COARSE\_COREA

### ADDRESS 0X21: OFFSET\_FINE\_COREA

The input offset of the ADC core can be adjusted in fine and coarse steps. Both adjustments are made via an 8-bit word as detailed in Table 7. The data format is two's complement. The data format is two's complement. Bit 0 in register 0xFE must be set high to enable updates written to 0x20 and 0x21 to be used by the ADC (see description for 0xFE).

The default value of each register will be the result of the self-calibration after initial power-up. If a register is to be incremented or decremented, the user should first read the register value then write the incremented or decremented value back to the same register.

TABLE 7. OFFSET ADJUSTMENTS

CoreA CoreB PARAMETER	0x20[7:0] 0x26[7:0] COARSE OFFSET	0x21[7:0] 0x27[7:0] FINE OFFSET
Steps	255	255
-Full Scale (0x00)	-133LSB (-47mV)	-5LSB (-1.75mV)
Mid-Scale (0x80)	0.0LSB (0.0mV)	0.0LSB
+Full Scale (0xFF)	+133LSB (+47mV)	+5LSB (+1.75mV)
Nominal Step Size	1.04LSB (0.37mV)	0.04LSB (0.014mV)

### ADDRESS 0X22: GAIN\_COARSE\_COREA

### ADDRESS 0X23: GAIN\_MEDIUM\_COREA

### ADDRESS 0X24: GAIN\_FINE\_COREA

Gain of the ADC core can be adjusted in coarse, medium and fine steps. Coarse gain is a 4-bit adjustment while medium and fine are 8-bit. Multiple Coarse Gain Bits can be set for a total adjustment range of  $\pm 4.2\%$ . ('0011'  $\cong -4.2\%$  and '1100'  $\cong +4.2\%$ ). It is recommended to use one of the coarse gain settings (-4.2%, -2.8%, -1.4%, 0, 1.4%, 2.8%, 4.2%) and fine-tune the gain using the registers at 0x0023 and 0x24.

The default value of each register will be the result of the self-calibration after initial power-up. If a register is to be incremented or decremented, the user should first read the register value then write the incremented or decremented value back to the same register. Bit 0 in register 0xFE must be set high

to enable updates written to 0x23 and 0x24 to be used by the ADC (see description for 0xFE)..

TABLE 8. COARSE GAIN ADJUSTMENT

0x22[3:0] CoreA 0x26[3:0] CoreB	NOMINAL COARSE GAIN ADJUST (%)
Bit3	+2.8
Bit2	+1.4
Bit1	-2.8
Bit0	-1.4

TABLE 9. MEDIUM AND FINE GAIN ADJUSTMENTS

CoreA CoreB PARAMETER	0x23[7:0] 0x29[7:0] MEDIUM GAIN	0x24[7:0] 0x2A[7:0] FINE GAIN
Steps	256	256
-Full Scale (0x00)	-2%	-0.20%
Mid-Scale (0x80)	0.00%	0.00%
+Full Scale (0xFF)	+2%	+0.2%
Nominal Step Size	0.016%	0.0016%

### ADDRESS 0X25: MODES

Two distinct reduced power modes can be selected. By default, the tri-level NAPSLP pin can select normal operation, nap or sleep modes (refer to "Nap/Sleep" on page 19). This functionality can be overridden and controlled through the SPI. This register is not changed by a Soft Reset.

TABLE 10. POWER-DOWN CONTROL

VALUE	0x25[2:0] POWER DOWN MODE
000	Pin Control
001	Normal Operation
010	Nap Mode
100	Sleep Mode

### ADDRESS 0X26: OFFSET\_COARSE\_COREB

### ADDRESS 0X27: OFFSET\_FINE\_COREB

The input offset of ADC CoreB can be adjusted in fine and coarse steps in the same way that offset for CoreA can be adjusted. Both adjustments are made via an 8-bit word as detailed in Table 7. The data format is two's complement. Bit 0 in register 0xFE must be set high to enable updates written to 0x26 and 0x27 to be used by the ADC (see description for 0xFE).

The default value of each register will be the result of the self-calibration after initial power-up. If a register is to be incremented or decremented, the user should first read the register value then write the incremented or decremented value back to the same register.

## ADDRESS 0X28: GAIN\_COARSE\_COREB

## ADDRESS 0X29: GAIN\_MEDIUM\_COREB

## ADDRESS 0X2A: GAIN\_FINE\_COREB

Gain of ADC CoreB can be adjusted in coarse, medium and fine steps in the same way that CoreA can be adjusted. Coarse gain is a 4-bit adjustment while medium and fine are 8-bit. Multiple Coarse Gain Bits can be set for a total adjustment range of  $\pm 4.2\%$ . Bit 0 in register 0xFE must be set high to enable updates written to 0x29 and 0x2A to be used by the ADC (see description for 0xFE).

## Global Device Configuration/Control

### ADDRESS 0X71: PHASE\_SLIP

When using the clock\_divide feature, the sample clock edge that the ADC uses to sample the analog input signal can be one of several different edges on the incoming higher frequency sample clock. For example, in clock\_divide = 2 mode, every other incoming sample clock edge gets used by the ADC to sample the analog input. The phase\_slip feature allows the system to control which edge of the incoming sample clock signals gets used to cause the sampling event, by “slipping” the sampling event by one input clock period each time phase\_slip is asserted.

The clkdivrst feature can work in conjunction with phase\_slip. After well-timed assertion of the clkdivrst signal (via overloading on the SYNC inputs), the sampling edge position with respect to the incoming clock rate will have been reset, allowing the system to “slip” whatever desired number of incoming clock periods from a known state.

### ADDRESS 0X72: CLOCK\_DIVIDE

The ADC has a selectable clock divider that can be set to divide by two or one (no division). By default, the tri-level CLKDIV pin selects the divisor. This functionality can be overridden and controlled through the SPI, as shown in Table 11. This register is not changed by a Soft Reset.

TABLE 11. CLOCK DIVIDER SELECTION

VALUE	0x72[2:0] CLOCK DIVIDER
000	Pin Control
001	Divide by 1
010	Divide by 2
other	Not Allowed

### ADDRESS 0X73: OUTPUT\_MODE\_A

The output\_mode\_A register controls the logical coding of the sample data. Data can be coded in three possible formats: two's complement(default), Gray code or offset binary. See Table 12.

This register is not changed by a Soft Reset.

TABLE 12. OUTPUT FORMAT CONTROL

VALUE	0x73[2:0] OUTPUT FORMAT
000	Two's Complement (Default)
010	Gray Code
100	Offset Binary

### ADDRESS 0X74: OUTPUT\_MODE\_B

#### Bit 6 DLL Range

This bit sets the DLL operating range to fast (default) or slow.

Internal clock signals are generated by a delay-locked loop (DLL), which has a finite operating range. Table 13 shows the allowable sample rate ranges for the slow and fast settings.

TABLE 13. DLL RANGES

DLL RANGE	MIN	MAX	UNIT
Slow	40	100	MSPS
Fast	80	250	MSPS

### ADDRESS 0X77: SYNC\_FUNCTION

#### BIT 0 CLKDIVRST

This bit controls the functionality of the SYNC, SYNCN pins on this device. By default, this bit equals '0', which means that the functionality of the SYNC, SYNCN pins is the JESD204 SYNC. Setting this bit equal to '1' modifies the functionality of the SYNC, SYNCN pins to be clkdivrst, which is a synchronous divider reset on all internal dividers in the device. Usage of this clkdivrst functionality is required to support multi-chip time alignment and deterministic latency for devices that use interleaved product configurations (ISLA214S50 and ISLA214S35), and for any other product configuration that uses clkdiv > 1. In both states, the setup and hold times with respect to the sample clock remain the same. Contact [Intersil sales support](#) for more details.

### ADDRESS 0XB6: CALIBRATION STATUS

The LSB at address 0xB6 can be read to determine calibration status. The bit is '0' during calibration and goes to a logic '1' when calibration is complete. This register is unique in that it can be read after POR at calibration, unlike the other registers on chip, which can't be read until calibration is complete.

## DEVICE TEST

The device can produce preset or user defined patterns on the digital outputs to facilitate in-situ testing. A user can pick from preset built-in patterns by writing to the output test mode field [7:4] at 0xC0 or user defined patterns by writing to the user test mode field [2:0] at 0xC0. The user defined patterns should be loaded at address space 0xC1 through 0xD0, see the “SPI Memory Map” on page 33 for more detail. The test mode is enabled asynchronously to the sample clock, therefore several sample clock cycles may elapse before the data is present on the output bus.

## ADDRESS 0XC0: TEST\_IO

Bits 7:4 Output Test Mode

These bits set the test mode according to the description in “SPI Memory Map” on page 33.

Bits 2:0 User Test Mode

The three LSBs in this register determine the test pattern in combination with registers 0xC1 through 0xD0. Refer to the “SPI Memory Map” on page 33.

## ADDRESS 0XC1: USER\_PATT1\_LSB

## ADDRESS 0XC2: USER\_PATT1\_MSB

These registers define the lower and upper eight bits, respectively, of the user-defined pattern 1.

## ADDRESS 0XC3: USER\_PATT2\_LSB

## ADDRESS 0XC4: USER\_PATT2\_MSB

These registers define the lower and upper eight bits, respectively, of the user-defined pattern 2

## ADDRESS 0XC5: USER\_PATT3\_LSB

## ADDRESS 0XC6: USER\_PATT3\_MSB

These registers define the lower and upper eight bits, respectively, of the user-defined pattern 3.

## ADDRESS 0XC7: USER\_PATT4\_LSB

## ADDRESS 0XC8: USER\_PATT4\_MSB

These registers define the lower and upper eight bits, respectively, of the user-defined pattern 4.

## ADDRESS 0XC9: USER\_PATT5\_LSB

## ADDRESS 0XCA: USER\_PATT5\_MSB

These registers define the lower and upper eight bits, respectively, of the user-defined pattern 5.

## ADDRESS 0XCB: USER\_PATT6\_LSB

## ADDRESS 0XCC: USER\_PATT6\_MSB

These registers define the lower and upper eight bits, respectively, of the user-defined pattern 6.

## ADDRESS 0XCD: USER\_PATT7\_LSB

## ADDRESS 0XCE: USER\_PATT7\_MSB

These registers define the lower and upper eight bits, respectively, of the user-defined pattern 7.

## ADDRESS 0XCF: USER\_PATT8\_LSB

## ADDRESS 0XD0: USER\_PATT8\_MSB

These registers define the lower and upper eight bits, respectively, of the user-defined pattern 8.

## ADDRESS 0xDF - 0xF3: JESD204 REGISTERS

### Address 0xDF-0xEE: JESD204 Parameter INTERFACE

This set of registers controls the JESD204 transmitter configuration. By programming these parameters, the system can select between efficient and simple packing, select the number of powered up SERDES lanes, choose the ADC resolution transmitted, and so on. The JESD204 parameters for standard dual channel products are shown in Table 4. This is a small subset of the total number of configurations supported; contact [Intersil sales support](#) for details.

0xE0 through 0xED are the JESD204 parameter registers. These parameters are written to set the transport layer mapping of the JESD204 transmitter in this product family. These registers can be written to shift between efficient and simple packing, to enable or bypass scrambling, and to reduce the number of powered up lanes used in the link. Each speed graded product allows downgrading of the JESD204 link (such as reducing the number of lanes, reducing the converter resolution, etc), but not upgrading. These parameters are communicated on every lane of the link during the 2nd multi-frame of the initial lane alignment sequence, and therefore can be used by a generic JESD204 receiver that supports the given configuration. See the JESD204 specification for additional information on how these registers are used in a JESD204 system, including encoding rules.

### ADDRESS 0XDF: JESD204\_UPDATE\_CONFIG\_START

Bit 0 update\_start

This self-resetting bit is used to indicate that some or all the JESD204 parameters (addresses 0xE0 through 0xED) are going to be written. Writing a ‘1’ to this bit will hold the JESD204 PLL and transmitter in a reset state while these parameters are written, because these parameters can affect the transmitter’s dynamic behavior (such as modifying the PLL’s frequency multiplication). The bit will automatically reset to a ‘0’ once a ‘1’ is written to address 0xEE Bit[0] “update\_config W1TC”. The recommended sequence for modifying the JESD204 transmitter is:

1. Write a ‘1’ to 0xDF Bit[0]
2. Write some or all modified values to 0xE0 through 0xEC
3. Write a ‘1’ to 0xEE Bit[0]. Note: 0xDF Bit[0] and 0xEE Bit[0] will automatically be reset to a ‘0’ once configuration has been applied to the circuitry.

### ADDRESS 0XE0: JESD204\_CONFIG\_0

Bits 7:0 “DID”, JESD204 Device ID number.

### ADDRESS 0XE1: JESD204\_CONFIG\_1

Bits 3:0 “BID”, JESD204 Bank ID.

### ADDRESS 0XE2: JESD204\_CONFIG\_2

Bits 4:0 “LID” JESD204 Lane ID.

## ADDRESS 0XE3: JESD204\_CONFIG\_3

**Bit 7 “SCR”**, JESD204 SCR controls if scrambling across the SERDES lane(s) is enabled (‘1’ means enabled).

**Bits 4:0 “L”**, JESD204 L is the number of SERDES lanes in the link.

Address 0xE4: jesd204\_config\_4

**Bits 7:0 “F”**, JESD204 Number of octets per frame period.

Address 0xE5: jesd204\_config\_5

**Bits 4:0 “K”** JESD204 Number of frame periods per multi-frame period. This product family supports the full programmable range of K (decimal 0 through 31), although note that the JESD204 standard dictates a minimum number for this parameter that is configuration dependent.

Address 0xE6: jesd204\_config\_6

**Bits 7:0 “M”** JESD204 Number of converters per device.

Address 0xE7: jesd204\_config\_7

**Bits 7:6 “CS”**, JESD204 CS is the number of control bits per sample (Always ‘0’ for this product family).

**Bits 4:0 “N”**, JESD204 N is the converter resolution.

Address 0xE8: jesd204\_config\_8

**Bits 4:0 “N”**, JESD204 N’ is the total number of bits per sample.

Address 0xE9: jesd204\_config\_9

**Bits 4:0 “S”**, JESD204 Number of samples per converter per frame cycle.

Address 0xEa: jesd204\_config\_10

**Bit 7 “HD”**, JESD204 HD indicates if a converter’s sample can be split across multiple lanes in the link (always ‘0’ for this product family).

**Bits 4:0 “CF”**, JESD204 CF is the number of control frames per frame clock (always ‘0’ for this product family).

Address 0xEb: jesd204\_config\_11

**Bits 7:0 “RES1”**, JESD204 reserved for future use.

Address 0xEc: jesd204\_config\_12

**Bits 7:0 “RES2”**, JESD204 reserved for future use.

Address 0xEd: jesd204\_config\_13

**Bits 7:0 “FCHK”** JESD204 checksum (unsigned sum MOD 256) of all the other JESD204 parameter register values. This is a read-only register, as the checksum is calculated by the device.

## ADDRESS 0XEE: JESD204\_UPDATE\_CONFIG\_COMPLETE

**Bit 0** update\_complete

This self-resetting bit is used to indicate that all the modifications to the JESD204 parameters are complete.

## ADDRESS 0XEF: JESD204\_PLL\_MONITOR\_RESET

**Bit 0** “pll\_lock\_mon\_rst”, This self resetting register resets the state of the 0xF0 Bit[0] “latched\_pll\_lockn” bit. The purpose of this pair of bits is as a debugging feature to the system designer. The “latched\_pll\_lockn” bit indicates if the JESD204 transmitter PLL inside the device has at any time lost lock since the last ‘1’ was written to the “pll\_lock\_mon\_rst” bit. This can be used to help identify the source of intermittent link lost errors in the system.

## ADDRESS 0XF0: JESD204\_STATUS

**Bit 2** “op\_cfg\_wrong” indicates if the JESD204 parameters (registers 0xE0 through 0xED) are supported by the JESD204 transmitter (a ‘1’ indicates they are not supported, a ‘0’ indicates they are supported).

**Bit 1** “pll\_lockn” indicates if the JESD204 transmitter PLL is currently locked (a ‘1’ indicates it is not locked, a ‘0’ indicates it is locked).

**Bit 0** “latched\_pll\_lockn” indicates if the JESD204 transmitter PLL has lost lock since the last assertion of the “pll\_lock\_mon\_rst” (see register 0xEF description for more information).

## ADDRESS 0XF1: JESD204\_SYNC

**Bit 0** “sync\_req” this register provides a SPI-programmable interface that can be used to assert and de-assert the JESD204 SYNC~ functionality. Certain systems may benefit from the elimination of SYNC~ as a separate board-level LVDS signal (and the power, PCB space, and pins it consumes), and these systems can use this register to functionally assert and de-assert SYNC~. For this bit to have any effect, a ‘1’ must have previously been written to the SYNC\_FUNCTION (Address 0x77, bit 0).

A ‘1’ written to this bit will result in behavior identical to the assertion of SYNC~ (comma character generation), and ‘0’ will result in the behavior identical to the de-assertion of SYNC~ (initial lane alignment sequence followed by converter data). Usage of this SPI SYNC~ capability may compromise the system’s ability to perform multi-chip time alignment, as the SYNC~ asserted to de-asserted transition using this register is not well timed with respect to sample clock.

## ADDRESS 0XF2: JESD204\_TRANS\_PAT\_CONFIG

**Bit 0** “no\_mf\_lane\_sync”, By default, this device family assumes that both sides of the link support lane synchronization. As per the JESD204 rev A standard, in this case continuous frame alignment monitoring via character substitution (section 5.3.3.4) is modified such that a different control character is substituted when the octet reoccurrence happens at the end of a multi-frame. This behavior occurs when bit 0 is ‘0’ (the power on default). Writing a ‘1’ to bit 0 will inform the JESD204 transmitter than the receiving device does not support lane synchronization, and therefore the transmitter will no longer substitute this different control character when reoccurrence of octets occurs at the end of a multi-frame.

**Bit 1** “trans\_pat\_max\_len” There is some ambiguity of the proper length of the JESD204 rev A section 5.1.6.2 required transport layer test pattern. Specifically, that the description perhaps should have “max()” in place of “min()” for the equation defining

the length of the pattern. Setting bit 1 in this register to a '0' (also the power-on default) and issuing this test pattern by writing to 0xC0 will cause the pattern to assume a "min()" interpretation of the pattern described in section 5.1.6.2. Setting the bit to a '1' will assume a "max()" interpretation of the described pattern.

### **ADDRESS 0xF3: JESD204\_CML\_POLARITY**

0xF3 Bit[2:0]: "TX polarity flip lane x" This register allows the system designer to invert the sense of the SERDES pins on a per lane basis. For example, writing a '1' to Bit[0] causes LANEON to functionally become LANEOP and LANEOP to become LANEON. This feature allows the system designer to avoid having to crossover P and N sides of the CML pair on the board to match pin out and layout of the transmitter and receiver. Typically, a trace crossover would require vias, which can degrade the signal integrity of the high-speed SERDES lanes.

### **ADDRESS 0xFE: OFFSET/GAIN\_ADJUST\_ENABLE**

Bit 0 at this register must be set high to enable adjustment of offset coarse and fine adjustments (0x20 and 0x21) and gain medium and gain fine adjustments(0x23 and 0x24). It is recommended that new data be written to the offset and gain adjustment registers (0x20, 0x21, 0x23, 0x24) while Bit 0 is a '0'. Subsequently, Bit 0 should be set to '1' to allow the values written to the aforementioned registers to be used by the ADC. Bit 0 should be set to a '0' upon completion.



## SPI Memory Map

	ADDR. (Hex)	PARAMETER NAME	BIT 7 (MSB)	BIT 6	BIT 5	BIT 4	BIT 3	BIT 2	BIT 1	BIT 0 (LSB)	DEF. VALUE (HEX)	
SPI Config/Control	00	port_config	SDO Active	LSB First	Soft Reset			Mirror (bit5)	Mirror (bit6)	Mirror (bit7)	00h	
	01	Reserved	Reserved									
	02	burst_end	Burst end address [7:0]									00h
	03-07	Reserved	Reserved									
DUT Info	08	chip_id	Chip ID #									Read only
	09	chip_version	Chip Version #									Read only
	0A-0F	Reserved	Reserved									
Device Config/Control	10-1F	Reserved	Reserved									
	20	offset_coarse_CoreA	Coarse Offset									cal. value
	21	offset_fine_CoreA	Fine Offset									cal. value
	22	gain_coarse_CoreA	Reserved				Coarse Gain				cal. value	
	23	gain_medium_CoreA	Medium Gain									cal. value
	24	gain_fine_CoreA	Fine Gain									cal. value
	25	modes_CoreA	Reserved					Power Down Mode CoreA [2:0] 000 = Pin Control 001 = Normal Operation 010 = Nap 100 = Sleep Other codes = Reserved				00h NOT reset by Soft Reset
	26	offset_coarse_CoreB	Coarse Offset									cal. value
	27	offset_fine_CoreB	Fine Offset									cal. value
	28	gain_coarse_CoreB	Reserved				Coarse Gain				cal. value	
	29	gain_medium_CoreB	Medium Gain									cal. value
	2A	gain_fine_CoreB	Fine Gain									cal. value
	2B	modes_CoreB	Reserved					Power Down Mode CoreB [2:0] 000 = Pin Control 001 = Normal Operation 010 = Nap 100 = Sleep Other codes = Reserved				00h NOT reset by Soft Reset
	2C-6F	Reserved	Reserved									
	70	skew_diff	Differential Skew									80h
	71	phase_slip	Reserved								Next Clock Edge	00h
	72	clock_divide							Clock Divide [2:0] 000 = Pin Control 001 = divide by 1 010 = divide by 2 100 = divide by 4 Other codes = Reserved			00h NOT reset by Soft Reset

# ISLA222S

## SPI Memory Map (Continued)

	ADDR. (Hex)	PARAMETER NAME	BIT 7 (MSB)	BIT 6	BIT 5	BIT 4	BIT 3	BIT 2	BIT 1	BIT 0 (LSB)	DEF. VALUE (HEX)	
Device Config/Control	73	output_mode_A						Output Format [2:0] 000 = Two's Complement (Default) 010 = Gray Code 100 = Offset Binary Other codes = Reserved			00h NOT reset by Soft Reset	
	74	output_mode_B		DLL Range 0 = Fast 1 = Slow Default='0							00h NOT reset by Soft Reset	
	75-76	Reserved	Reserved									
	77	SYNC_function								Clkdivrst		
	78-B5	Reserved	Reserved									
	B6	cal_status	Reserved								Calibration Done	Read Only
	B7-BF	Reserved										

# ISLA222S

## SPI Memory Map (Continued)

ADDR. (Hex)	PARAMETER NAME	BIT 7 (MSB)	BIT 6	BIT 5	BIT 4	BIT 3	BIT 2	BIT 1	BIT 0 (LSB)	DEF. VALUE (HEX)		
Device Test	C0	test_io				Output Test Mode [7:4]		JESD Test		User Test Mode [2:0]		00h
			<p>&lt;7:4&gt;=Output Test, &lt;3&gt; = JESD Test            JESD Test=0            Output Test =</p> <p>0x0= Output Test Mode Off. During calibration MSB justified constant output 0xCCCC            0x1 = Midscale adjusted by numeric format            0x2 = Plus full scale, adjusted by numeric format            0x3 = Minus full scale adjusted by numeric format            0x4 = Checkboard output - 0xAAAA, 0x5555            0x5 = reserved            0x6 = reserved            0x7 = 0xFFFF, 0x0000 all on pattern            0x8 = User pattern 8 deep, MSB justified with output            0x9 = reserved            0xA, Count-up ramp            0xB, PRBS-9            0xC, PRBS-15            0xD, PRBS-23            0xE, PRBS-31            0xF = reserved            JESD Test=1            Output Test =</p> <p>0x0 =Link Layer Repeat K28.5+Lane Alignment Sequence            0x1, Link Layer Repeat K28.5            0x2, Link Layer Repeat D21.5            0x3, Link Layer Repeat K28.7            0x4, Link Layer PRBS-7            0x5, Link Layer PRBS-23            0x6, Link Layer All Zeros            0x7, Link Layer All Ones            0x8-0xE, reserved            0xF, JESD204 section 5.1.6.2 Transport Layer Test Pattern</p>						<p>User Test Mode (Single ADC products only)            0 = user pattern 1 only            1 = cycle pattern 1 through 2            2 = cycle pattern 1 through 3            3 = cycle pattern 1 through 4            4 = cycle pattern 1 through 5            5 = cycle pattern 1 through 6            6 = cycle pattern 1 through 7            7 = cycle pattern 1 through 8            User Test Mode (Dual and interleaved ADC products only)            0 = cycle pattern 1 through 2            1 = cycle pattern 1 through 4            2 = cycle pattern 1 through 6            3 = cycle pattern 1 through 8            4 -7 = NA</p>			
	C1	user_patt1_lsb	B7	B6	B5	B4	B3	B2	B1	B0	00h	
	C2	user_patt1_msb	B15	B14	B13	B12	B11	B10	B9	B8	00h	
	C3	user_patt2_lsb	B7	B6	B5	B4	B3	B2	B1	B0	00h	
	C4	user_patt2_msb	B15	B14	B13	B12	B11	B10	B9	B8	00h	
	C5	user_patt3_lsb	B7	B6	B5	B4	B3	B2	B1	B0	00h	
	C6	user_patt3_msb	B15	B14	B13	B12	B11	B10	B9	B8	00h	
	C7	user_patt4_lsb	B7	B6	B5	B4	B3	B2	B1	B0	00h	
	C8	user_patt4_msb	B15	B14	B13	B12	B11	B10	B9	B8	00h	
	C9	user_patt5_lsb	B7	B6	B5	B4	B3	B2	B1	B0	00h	
	CA	user_patt5_msb	B15	B14	B13	B12	B11	B10	B9	B8	00h	
	CB	user_patt6_lsb	B7	B6	B5	B4	B3	B2	B1	B0	00h	
	CC	user_patt6_msb	B15	B14	B13	B12	B11	B10	B9	B8	00h	
	CD	user_patt7_lsb	B7	B6	B5	B4	B3	B2	B1	B0	00h	
	CE	user_patt7_msb	B15	B14	B13	B12	B11	B10	B9	B8	00h	
	CF	user_patt8_lsb	B7	B6	B5	B4	B3	B2	B1	B0	00h	
D0	user_patt8_msb	B15	B14	B13	B12	B11	B10	B9	B8	00h		
D1-DE	Reserved	Reserved										

# ISLA222S

## SPI Memory Map (Continued)

ADDR. (Hex)	PARAMETER NAME	BIT 7 (MSB)	BIT 6	BIT 5	BIT 4	BIT 3	BIT 2	BIT 1	BIT 0 (LSB)	DEF. VALUE (HEX)		
DF	JESD204_update_config_start								update_start	00h		
E0	JESD204_config_0	<i>DID</i> (Device ID Number)								See Description for Default Settings	00h	
E1	JESD204_config_1	<i>BID</i> (Bank ID Number)										
E2	JESD204_config_2	<i>LID</i> (Lane ID Number)										
E3	JESD204_config_3	SCR	<i>L</i> (Number of Lanes per Device)									
E4	JESD204_config_4	<i>F</i> (Number of Octets per Frame)										
E5	JESD204_config_5	<i>K</i> (Number of frames per multi-frame)										
E6	JESD204_config_6	<i>M</i> (Number of Converters per Device)										
E7	JESD204_config_7	CS (Number of Control bits per Sample)		<i>N</i> (Converter Resolution in bits)								
E8	JESD204_config_8	<i>N'</i> (Total number of bits per Sample)										
E9	JESD204_config_9	<i>S</i> (Number of Samples per Converter per Frame)										
EA	JESD204_config_10	HD	<i>CF</i> (Number of Control Words per Frame per Link)									
EB	JESD204_config_11	RES1										
EC	JESD204_config_12	RES2										
ED	JESD204_config_13	<i>FCHK</i> (Checksum)										
EE	JESD204_update_config_complete								update_complete	00h		
EF	JESD204_PLL_monitor_reset								pll_lock_mon_rst	00h		
F0	JESD204_status						op_cfg_wrong	pll_lockn	latched_pll_lockn	00h		
F1	JESD204_sync								sync_req			
F2	JESD204_trans_pat_config							trans_pat_max_len	no_mf_lane_sync			
F3	JESD204_CML_polarity						lane_2_polarity	lane_1_polarity	lane_0_polarity	00h		
F4-FD	Reserved	Reserved										
FE	Offset/Gain_Adjust_Enable								Enable '1'=Enable	00h		
FF	Reserved	Reserved										

Equivalent Circuits

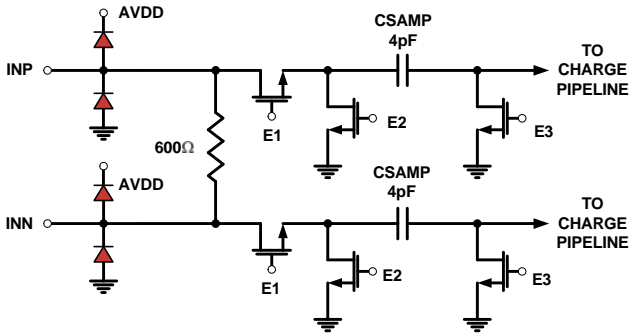

FIGURE 60. ANALOG INPUTS

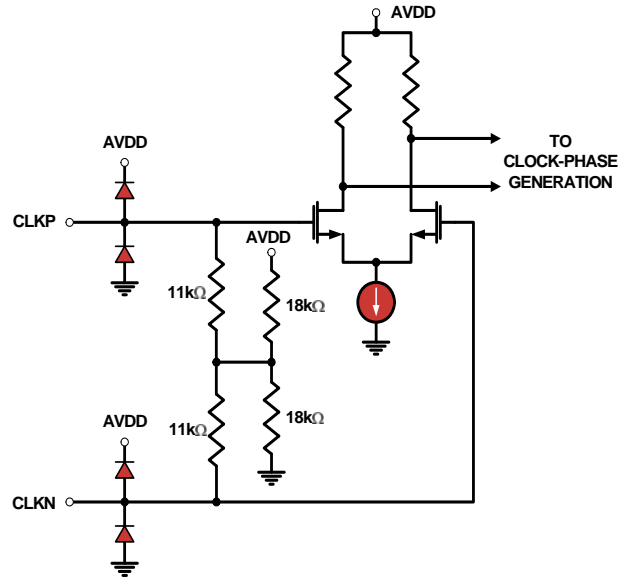

FIGURE 61. CLOCK INPUTS

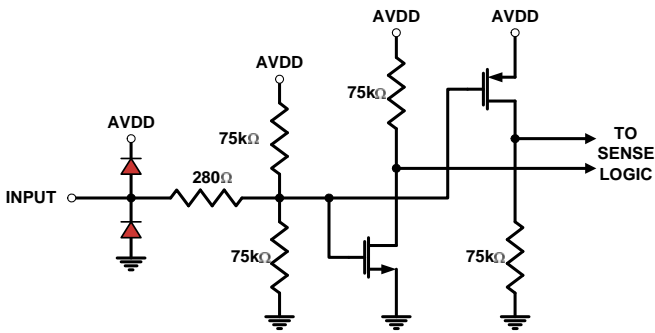

FIGURE 62. TRI-LEVEL DIGITAL INPUTS

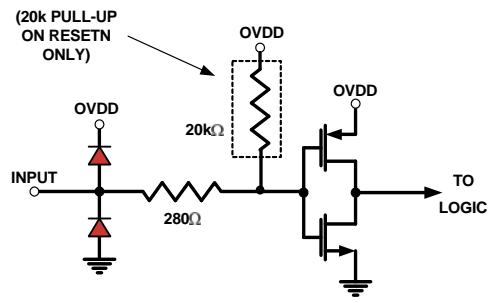

FIGURE 63. DIGITAL INPUTS

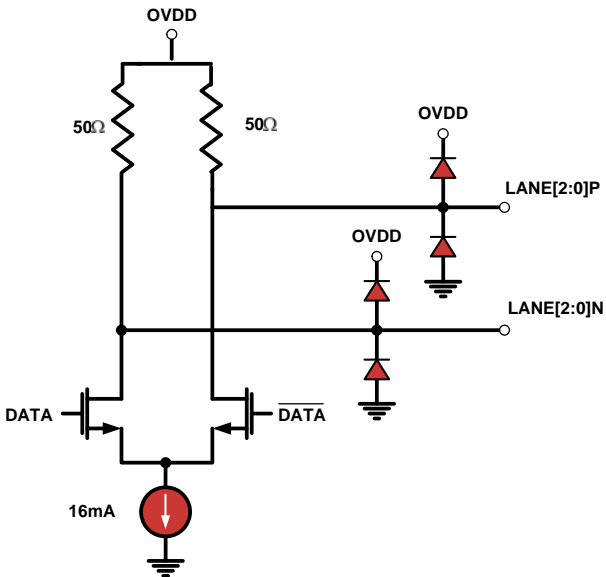

FIGURE 64. CML OUTPUTS

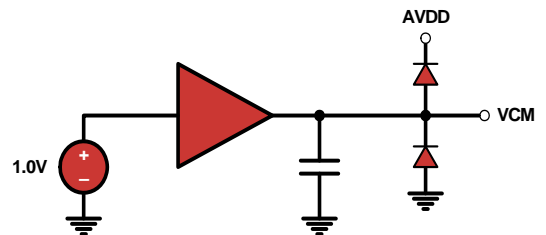

FIGURE 65. VCM\_OUT OUTPUT

## ADC Evaluation Platform

Intersil offers ADC Evaluation platforms which can be used to evaluate any of Intersil's high speed ADC products. Each platform consists of a FPGA based data capture motherboard and a family of ADC daughtercards. The USB interface and evaluation platform control software allow a user to quickly evaluate the ADC's performance at a user's specific application frequency requirements. More information is available at [http://www.intersil.com/converters/adc\\_eval\\_platform/](http://www.intersil.com/converters/adc_eval_platform/)

## Layout Considerations

### Split Ground and Power Planes

Data converters operating at high sampling frequencies require extra care in PC board layout. Many complex board designs benefit from isolating the analog and digital sections. Analog supply and ground planes should be laid out under signal and clock inputs. Locate the digital planes under outputs and logic pins. Grounds should be joined under the chip.

### Clock Input Considerations

Use matched transmission lines to the transformer inputs for the analog input and clock signals. Locate transformers and terminations as close to the chip as possible.

### Exposed Paddle

The exposed paddle must be electrically connected to analog ground (AVSS) and should be connected to a large copper plane using numerous vias for optimal thermal performance.

### Bypass and Filtering

Bulk capacitors should have low equivalent series resistance. Tantalum is a good choice. For best performance, keep ceramic bypass capacitors very close to device pins, as longer traces between the ceramic bypass capacitors and the device pins will increase inductance, which can result in diminished dynamic performance. Best practices bypassing is especially important on the AVDD and OVDD(PLL) power supply pins. Whenever possible, each supply pin should have its own 0.1uF bypass capacitor. Make sure that connections to ground are direct and low impedance. Avoid forming ground loops.

### CML Outputs

Output traces and connections must be designed for 50Ω (100Ω differential) characteristic impedance. Keep traces direct and short, and minimize bends and vias where possible. Avoid crossing ground and power-plane breaks with signal traces. Keep good clearance (at least 5 trace widths) between the SERDES traces and other signals. Given the speed of these outputs and importance of maintaining an open eye to achieve low BER, signal integrity simulations are recommended, especially when the data lane rate exceeds 3Gbps and/or the trace or cable length between the ADC and the receiver gets larger than 20cm.

### Unused Inputs

Standard logic inputs (RESETN, CSB, SCLK, SDIO, SDO) which will not be operated do not require connection to ensure optimal ADC performance. These inputs can be left floating if they are not

used. Tri-level inputs (NAPSLP) accept a floating input as a valid state, and therefore should be biased according to the desired functionality.

## Definitions

**Analog Input Bandwidth** is the analog input frequency at which the spectral output power at the fundamental frequency (as determined by FFT analysis) is reduced by 3dB from its full-scale low-frequency value. This is also referred to as Full Power Bandwidth.

**Aperture Delay or Sampling Delay** is the time required after the rise of the clock input for the sampling switch to open, at which time the signal is held for conversion.

**Aperture Jitter** is the RMS variation in aperture delay for a set of samples.

**Clock Duty Cycle** is the ratio of the time the clock wave is at logic high to the total time of one clock period.

**Differential Non-Linearity (DNL)** is the deviation of any code width from an ideal 1 LSB step.

**Effective Number of Bits (ENOB)** is an alternate method of specifying Signal to Noise-and-Distortion Ratio (SINAD). In dB, it is calculated as:  $ENOB = (SINAD - 1.76)/6.02$

**Gain Error** is the ratio of the difference between the voltages that cause the lowest and highest code transitions to the full-scale voltage less than 2 LSB. It is typically expressed in percent.

**I2E** The Intersil Interleave Engine. This highly configurable circuitry performs estimates of offset, gain, and sample time skew mismatches between the core converters, and updates analog adjustments for each to minimize interleave spurs.

**Integral Non-Linearity (INL)** is the maximum deviation of the ADC's transfer function from a best fit line determined by a least squares curve fit of that transfer function, measured in units of LSBs.

**Least Significant Bit (LSB)** is the bit that has the smallest value or weight in a digital word. Its value in terms of input voltage is  $V_{FS}/(2^N - 1)$  where N is the resolution in bits.

**Missing Codes** are output codes that are skipped and will never appear at the ADC output. These codes cannot be reached with any input value.

**Most Significant Bit (MSB)** is the bit that has the largest value or weight.

**Pipeline Delay** is the number of clock cycles between the initiation of a conversion and the appearance at the output pins of the data.

**Power Supply Rejection Ratio (PSRR)** is the ratio of the observed magnitude of a spur in the ADC FFT, caused by an AC signal superimposed on the power supply voltage.

**Signal to Noise-and-Distortion (SINAD)** is the ratio of the RMS signal amplitude to the RMS sum of all other spectral components below one half the clock frequency, including harmonics but excluding DC.

# ISLA222S

**Signal-to-Noise Ratio** (without Harmonics) is the ratio of the RMS signal amplitude to the RMS sum of all other spectral components below one-half the sampling frequency, excluding harmonics and DC.

SNR and SINAD are either given in units of dB when the power of the fundamental is used as the reference, or dBFS (dB to full scale) when the converter's full-scale input power is used as the reference.

**Spurious-Free-Dynamic Range (SFDR)** is the ratio of the RMS signal amplitude to the RMS value of the largest spurious spectral component. The largest spurious spectral component may or may not be a harmonic.

## Revision History

The revision history provided is for informational purposes only and is believed to be accurate, but not warranted. Please go to web to make sure you have the latest Rev.

DATE	REVISION	CHANGE
May 1, 2012	FN8302.0	Initial Release

Intersil Corporation is a leader in the design and manufacture of high-performance analog semiconductors. The Company's products address some of the industry's fastest growing markets, such as, flat panel displays, cell phones, handheld products, and notebooks. Intersil's product families address power management and analog signal processing functions. Go to [www.intersil.com/products](http://www.intersil.com/products) for a complete list of Intersil product families.

For a complete listing of Applications, Related Documentation and Related Parts, please see the respective device information page on intersil.com: [ISLA222S12](http://www.intersil.com/products/isla222s12), [ISLA222S20](http://www.intersil.com/products/isla222s20), [ISLA222S25](http://www.intersil.com/products/isla222s25).

To report errors or suggestions for this datasheet, please go to: [www.intersil.com/askourstaff](http://www.intersil.com/askourstaff)

FITs are available from our website at: <http://rel.intersil.com/reports/search.php>

For additional products, see [www.intersil.com/product\\_tree](http://www.intersil.com/product_tree)

Intersil products are manufactured, assembled and tested utilizing ISO9000 quality systems as noted in the quality certifications found at [www.intersil.com/design/quality](http://www.intersil.com/design/quality)

*Intersil products are sold by description only. Intersil Corporation reserves the right to make changes in circuit design, software and/or specifications at any time without notice. Accordingly, the reader is cautioned to verify that data sheets are current before placing orders. Information furnished by Intersil is believed to be accurate and reliable. However, no responsibility is assumed by Intersil or its subsidiaries for its use; nor for any infringements of patents or other rights of third parties which may result from its use. No license is granted by implication or otherwise under any patent or patent rights of Intersil or its subsidiaries.*

For information regarding Intersil Corporation and its products, see [www.intersil.com](http://www.intersil.com)

## Package Outline Drawing

### L48.7x7G

48 LEAD QUAD FLAT NO-LEAD PLASTIC PACKAGE

Rev 0, 1/10

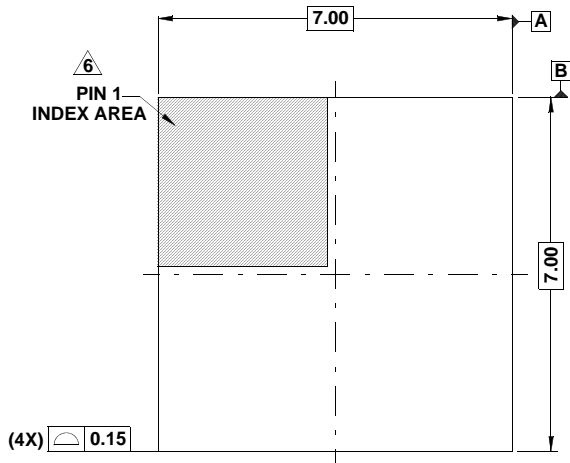

**TOP VIEW**

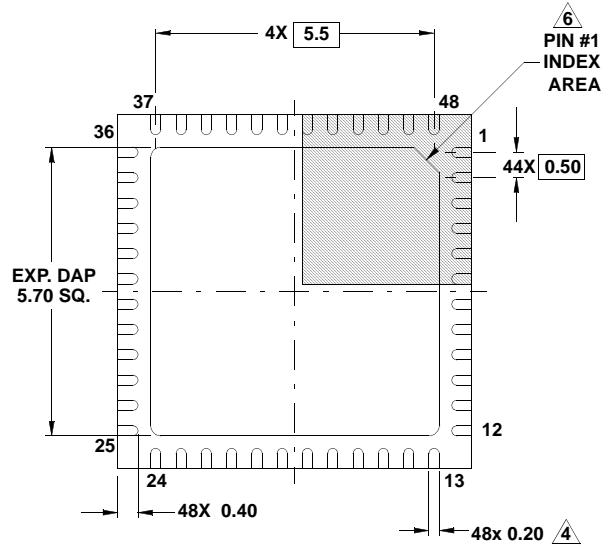

**BOTTOM VIEW**

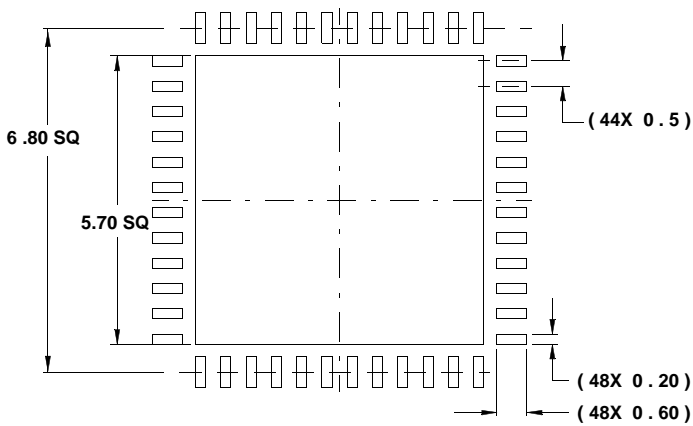

**TYPICAL RECOMMENDED LAND PATTERN**

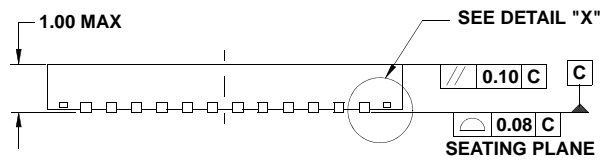

**SIDE VIEW**

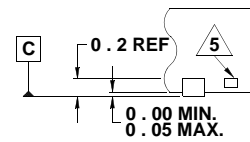

**DETAIL "X"**

**NOTES:**

1. Dimensions are in millimeters.  
Dimensions in ( ) for Reference Only.
2. Dimensioning and tolerancing conform to ASME Y14.5m-1994.
3. Unless otherwise specified, tolerance : Decimal  $\pm 0.05$
4. Dimension applies to the metallized terminal and is measured between 0.015mm and 0.30mm from the terminal tip.
5. Tiebar shown (if present) is a non-functional feature.
6. The configuration of the pin #1 identifier is optional, but must be located within the zone indicated. The pin #1 identifier may be either a mold or mark feature.