

# 2MBI600U4G-120

IGBT Modules

## IGBT MODULE (U series) 1200V / 600A / 2 in one package

### ■ Features

- High speed switching
- Voltage drive
- Low Inductance module structure

### ■ Applications

- Inverter for Motor Drive
- AC and DC Servo Drive Amplifier
- Uninterruptible Power Supply
- Industrial machines, such as Welding machines



### ■ Maximum Ratings and Characteristics

#### ● Absolute Maximum Ratings (at Tc=25°C unless otherwise specified)

Items	Symbols	Conditions	Maximum ratings	Units	
Collector-Emitter voltage	V <sub>CEs</sub>		1200	V	
Gate-Emitter voltage	V <sub>GES</sub>		±20	V	
Collector current	I <sub>c</sub>	Continuous	Tc=25°C	800	A
			Tc=80°C	600	
	I <sub>c</sub> pulse	1ms	Tc=25°C	1600	
			Tc=80°C	1200	
	-I <sub>c</sub>			600	
-I <sub>c</sub> pulse	1ms		1200		
Collector power dissipation	P <sub>c</sub>	1 device	3670	W	
Junction temperature	T <sub>j</sub>		150	°C	
Storage temperature	T <sub>stg</sub>		-40 ~ +125		
Isolation voltage	Between terminal and copper base (*1)	AC : 1min.	4000	VAC	
	Mounting (*2)		5.75		
Screw torque	Terminals (*3)		10	N m	
			2.5		

Note \*1: All terminals should be connected together when isolation test will be done.

Note \*2: Recommendable Value : Mounting 4.25~5.75 Nm (M6)

Note \*3: Recommendable Value : Main Terminals 8~10 Nm (M8)

Sense Terminals 1.7~2.5 Nm (M4)

#### ● Electrical characteristics (at Tj= 25°C unless otherwise specified)

Items	Symbols	Conditions	Characteristics			Units	
			min.	typ.	max.		
Zero gate voltage collector current	I <sub>CEs</sub>	V <sub>GE</sub> = 0V, V <sub>CE</sub> = 1200V	-	-	1.0	mA	
Gate-Emitter leakage current	I <sub>GES</sub>	V <sub>CE</sub> = 0V, V <sub>GE</sub> = ±20V	-	-	1200	nA	
Gate-Emitter threshold voltage	V <sub>GE(th)</sub>	V <sub>CE</sub> = 20V, I <sub>c</sub> = 600mA	5.5	6.5	7.5	V	
Collector-Emitter saturation voltage	V <sub>CE(sat)</sub> (main terminal)	V <sub>GE</sub> = 15V I <sub>c</sub> = 600A	Tj=25°C	-	2.08	2.26	V
			Tj=125°C	-	2.28	-	
	V <sub>CE(sat)</sub> (chip)		Tj=25°C	-	1.90	2.05	
			Tj=125°C	-	2.10	-	
Input capacitance	C <sub>ies</sub>	V <sub>CE</sub> = 10V, V <sub>GE</sub> = 0V, f = 1MHz	-	68	-	nF	
Turn-on	t <sub>on</sub>	V <sub>CC</sub> = 600V I <sub>c</sub> = 600A R <sub>son</sub> = 6.8Ω R <sub>goff</sub> = 2Ω	-	1.35	-	μs	
	t <sub>r</sub>		-	0.65	-		
Turn-off	t <sub>off</sub>	V <sub>GE</sub> = ±15V Tj = 125°C	-	0.80	-	μs	
	t <sub>f</sub>		-	0.20	-		
Forward on voltage	V <sub>F</sub> (main terminal)	V <sub>GE</sub> = 0V I <sub>F</sub> = 600A	Tj=25°C	-	1.83	2.01	V
			Tj=125°C	-	1.93	-	
	V <sub>F</sub> (chip)		Tj=25°C	-	1.65	1.80	
			Tj=125°C	-	1.75	-	
Reverse recovery	t <sub>rr</sub>	I <sub>F</sub> = 600A	-	0.45	-	μs	
Lead resistance, terminal-chip (*4)	R <sub>lead</sub>		-	0.29	-	mΩ	

Note \*4: Biggest internal terminal resistance among arm.

#### ● Thermal resistance characteristics

Items	Symbols	Conditions	Characteristics			Units
			min.	typ.	max.	
Thermal resistance (1device)	R <sub>th(j-c)</sub>	IGBT FWD	-	-	0.034	°C/W
Contact thermal resistance (1device)	R <sub>th(c-f)</sub>	with Thermal Compound (*5)	-	0.006	-	

Note \*5: This is the value which is defined mounting on the additional cooling fin with thermal compound.

■ Characteristics (Representative)

Collector current vs. Collector-Emitter voltage (typ.)  
Tj=25°C, chip

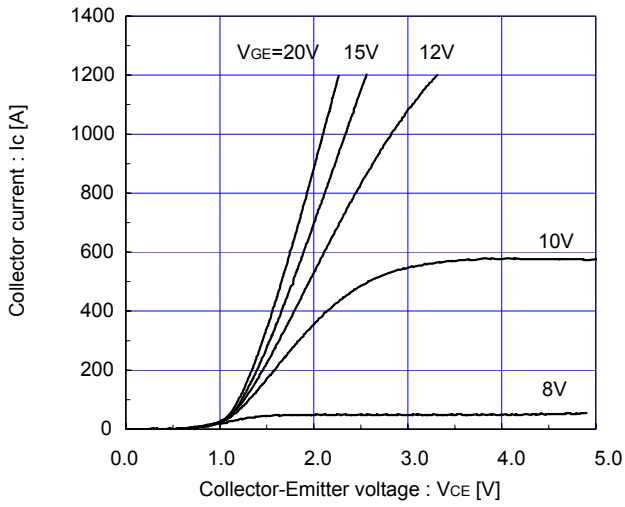

Collector current vs. Collector-Emitter voltage (typ.)  
Tj= 125°C, chip

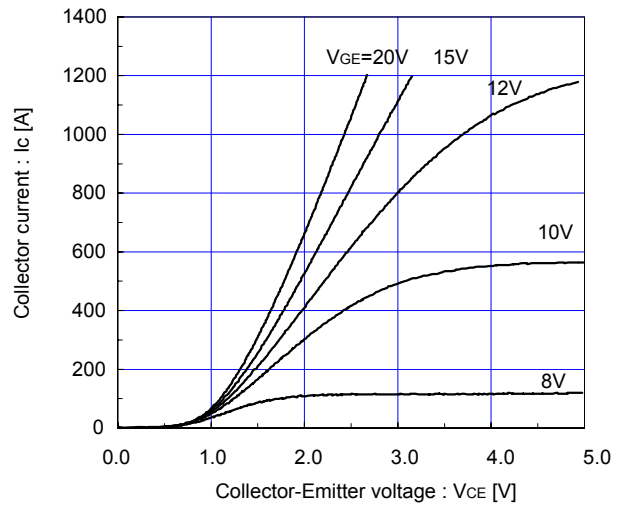

Collector-Emitter voltage vs. Gate-Emitter voltage (typ.)  
VGE=+15V, chip

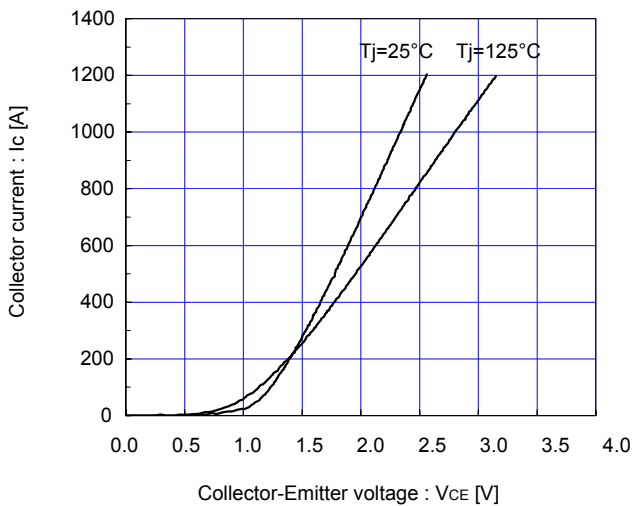

Collector-Emitter voltage vs. Gate-Emitter voltage (typ.)  
Tj=25°C, chip

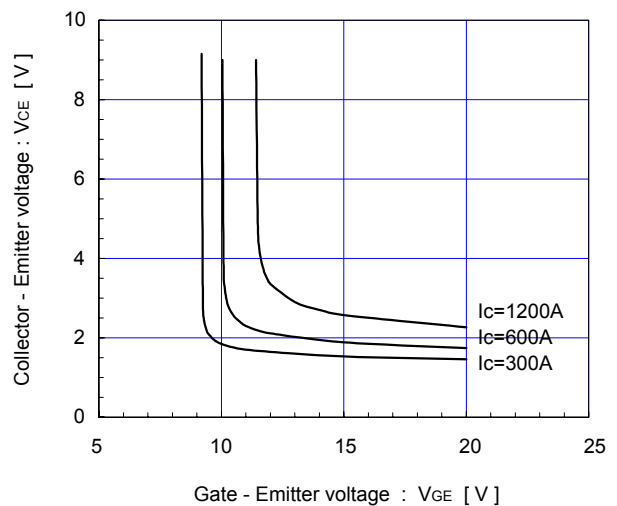

Capacitance vs. Collector-Emitter voltage (typ.)  
VGE=0V, f= 1MHz, Tj= 25°C

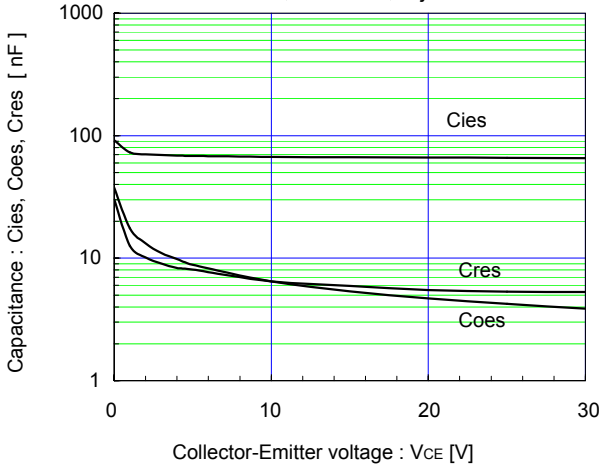

Dynamic Gate charge (typ.)  
Vcc=600V, Ic=600A, Tj= 25°C

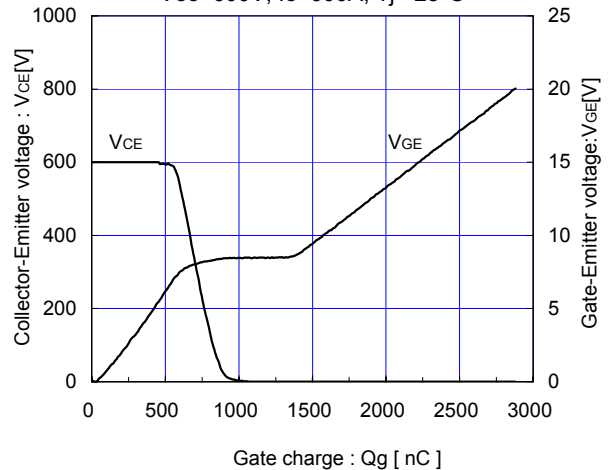

Switching time vs. Collector current (typ.)

V<sub>cc</sub>=600V, V<sub>GE</sub>=±15V, R<sub>Gon</sub>=6.8Ω, R<sub>Goff</sub>=2Ω, T<sub>j</sub>= 125°C

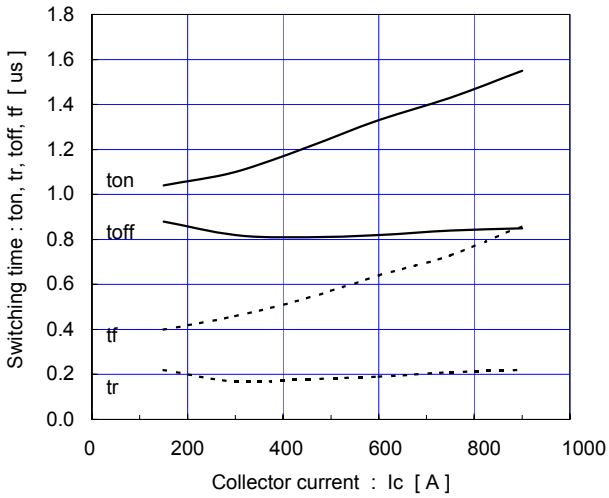

Switching time vs. Gate resistance (typ.)

V<sub>cc</sub>=600V, I<sub>c</sub>=600A, V<sub>GE</sub>=±15V, T<sub>j</sub>=125°C

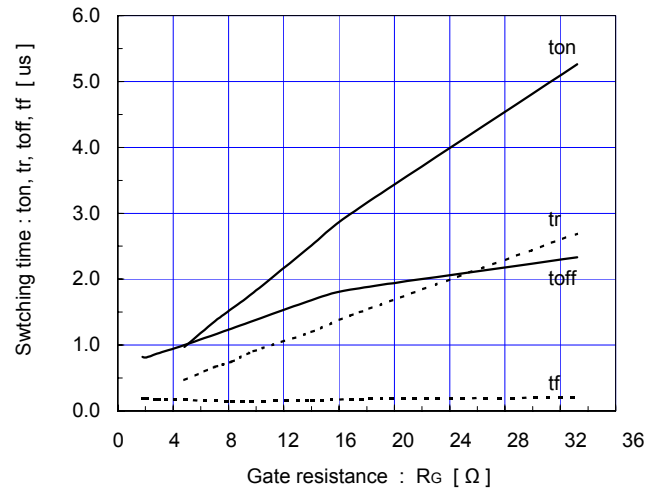

Switching loss vs. Collector current (typ.)

V<sub>cc</sub>=600V, V<sub>GE</sub>=±15V, R<sub>Gon</sub>=6.8Ω, R<sub>Goff</sub>=2Ω, T<sub>j</sub>= 125°C

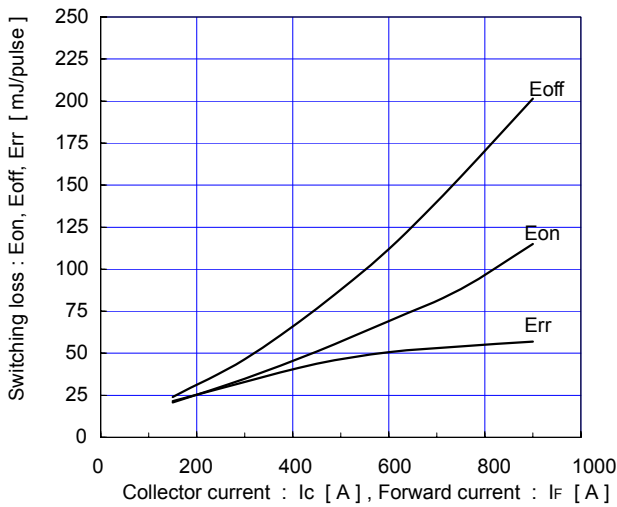

Switching loss vs. Gate resistance (typ.)

V<sub>cc</sub>=600V, I<sub>c</sub>=600A, V<sub>GE</sub>=±15V, T<sub>j</sub>=125°C

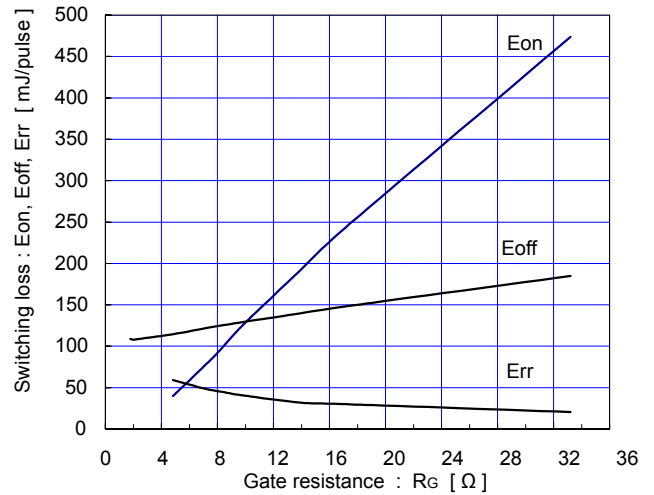

Reverse bias safe operating area (max.)

±V<sub>GE</sub>=15V, T<sub>j</sub> = 125°C / chip

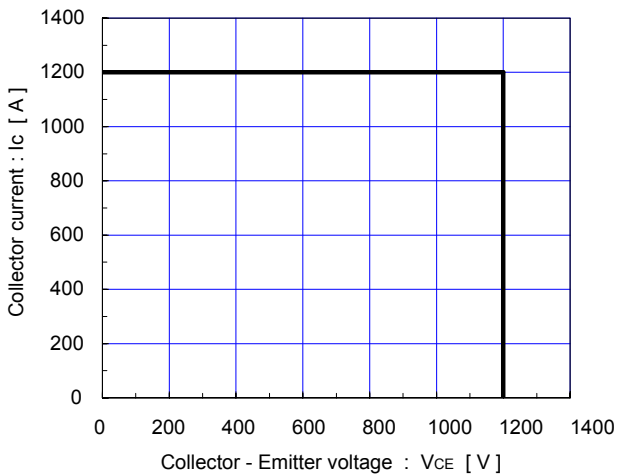

Forward current vs. Forward on voltage (typ.)  
chip

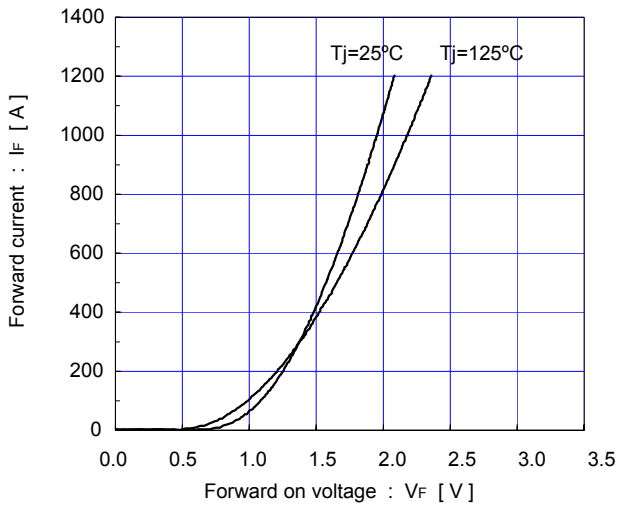

Reverse recovery characteristics (typ.)  
 $V_{CC}=600\text{V}$ ,  $V_{GE}=\pm 15\text{V}$ ,  $R_G=6.8\Omega$ ,  $T_j=125^\circ\text{C}$

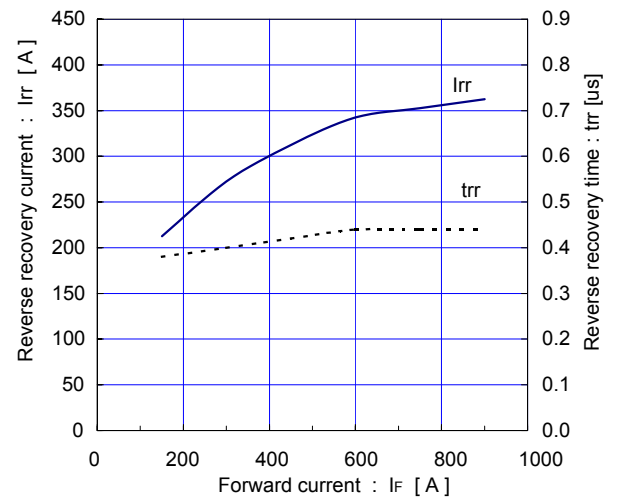

Transient thermal resistance (max.)

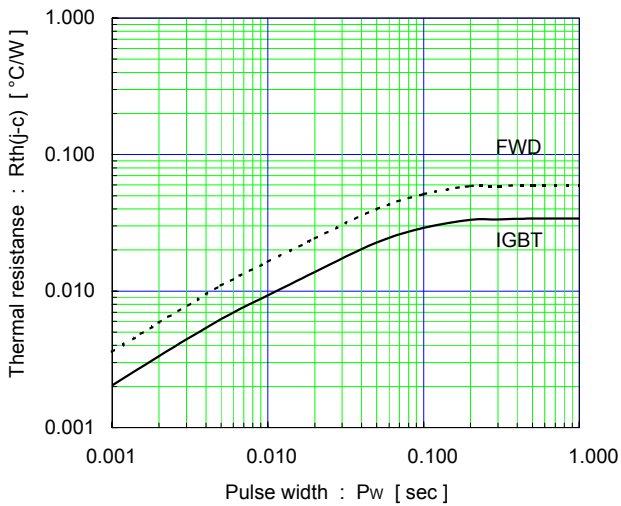

■ Outline Drawings, mm

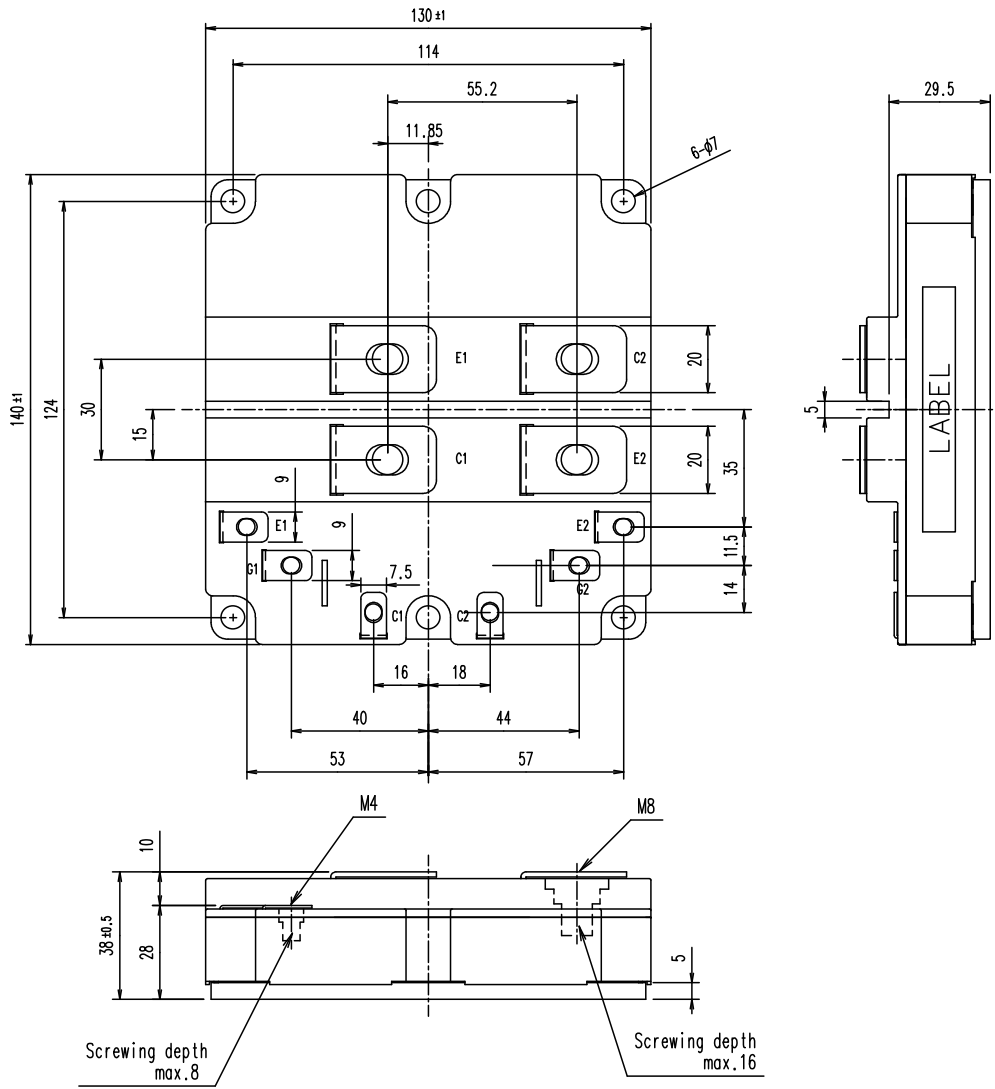

■ Equivalent Circuit Schematic

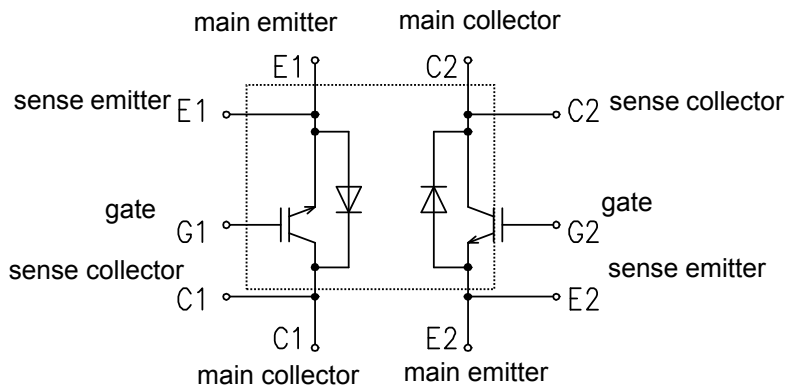

**WARNING**

1. This Catalog contains the product specifications, characteristics, data, materials, and structures as of May 2011. The contents are subject to change without notice for specification changes or other reasons. When using a product listed in this Catalog, be sure to obtain the latest specifications.
2. All applications described in this Catalog exemplify the use of Fuji's products for your reference only. No right or license, either express or implied, under any patent, copyright, trade secret or other intellectual property right owned by Fuji Electric Co., Ltd. is (or shall be deemed) granted. Fuji Electric Co., Ltd. makes no representation or warranty, whether express or implied, relating to the infringement or alleged infringement of other's intellectual property rights which may arise from the use of the applications described herein.
3. Although Fuji Electric Co., Ltd. is enhancing product quality and reliability, a small percentage of semiconductor products may become faulty. When using Fuji Electric semiconductor products in your equipment, you are requested to take adequate safety measures to prevent the equipment from causing a physical injury, fire, or other problem if any of the products become faulty. It is recommended to make your design failsafe, flame retardant, and free of malfunction.
4. The products introduced in this Catalog are intended for use in the following electronic and electrical equipment which has normal reliability requirements.
  - Computers
  - OA equipment
  - Communications equipment (terminal devices)
  - Measurement equipment
  - Machine tools
  - Audiovisual equipment
  - Electrical home appliances
  - Personal equipment
  - Industrial robots etc.
5. If you need to use a product in this Catalog for equipment requiring higher reliability than normal, such as for the equipment listed below, it is imperative to contact Fuji Electric Co., Ltd. to obtain prior approval. When using these products for such equipment, take adequate measures such as a backup system to prevent the equipment from malfunctioning even if a Fuji's product incorporated in the equipment becomes faulty.
  - Transportation equipment (mounted on cars and ships)
  - Trunk communications equipment
  - Traffic-signal control equipment
  - Gas leakage detectors with an auto-shut-off feature
  - Emergency equipment for responding to disasters and anti-burglary devices
  - Safety devices
  - Medical equipment
6. Do not use products in this Catalog for the equipment requiring strict reliability such as the following and equivalents to strategic equipment (without limitation).
  - Space equipment
  - Aeronautic equipment
  - Nuclear control equipment
  - Submarine repeater equipment
7. Copyright ©1996-2011 by Fuji Electric Co., Ltd. All rights reserved.  
No part of this Catalog may be reproduced in any form or by any means without the express permission of Fuji Electric Co., Ltd.
8. If you have any question about any portion in this Catalog, ask Fuji Electric Co., Ltd. or its sales agents before using the product. Neither Fuji Electric Co., Ltd. nor its agents shall be liable for any injury caused by any use of the products not in accordance with instructions set forth herein.