

PLEASE CHECK WWW.MOLEX.COM FOR LATEST PART INFORMATION

Part Number: [0905842308](#)
Status: **Active**
Description: 1.27mm (.050") Pitch Picoflex® PF-50 IDT Receptacle, Low Profile, Board-In, 8 Circuits

Documents:

[3D Model](#) [Product Specification PS-99020-0011 \(PDF\)](#)
[Drawing \(PDF\)](#) [RoHS Certificate of Compliance \(PDF\)](#)
[Product Specification ES-99033-0002 \(PDF\)](#)

General

Product Family	Ribbon Cable / Wire Trap Connectors
Series	90584
Comments	Low Profile
Component Type	One Piece
Glow-Wire Compliant	No
Product Name	Board-In, Picoflex®

Physical

Circuits (Loaded)	8
Color - Resin	Natural
Durability (mating cycles max)	30
Entry Angle	90° Angle
Lock to Mating Part	None
Material - Metal	Phosphor Bronze
Material - Plating Mating	Tin
Material - Plating Termination	Tin
Material - Resin	Polyester
Number of Rows	2
PCB Locator	No
PCB Retention	Yes
PCB Thickness Recommended (in)	0.062 In
PCB Thickness Recommended (mm)	1.60 mm
Packaging Type	Tube - Stacked
Pitch - Mating Interface (in)	0.050 In
Pitch - Mating Interface (mm)	1.27 mm
Plating min: Mating (µin)	80.00
Plating min: Mating (µm)	2.00
Plating min: Termination (µin)	80.00
Plating min: Termination (µm)	2.00
Polarized to Mating Part	N/A
Polarized to PCB	Yes
Stackable	No
Surface Mount Compatible (SMC)	No
Temperature Range - Operating	-40°C to +105°C
Termination Interface: Style	Through Hole - Kinked Pin
Wire Insulation Diameter	1.00mm (.039") max.
Wire Size AWG	26, 28
Wire/Cable Type	Ribbon Cable

Electrical

Current - Maximum per Contact	1.2A
Voltage - Maximum	250V

Solder Process Data

Lead-free Process Capability	Wave Capable (TH only)
------------------------------	------------------------

Material Info

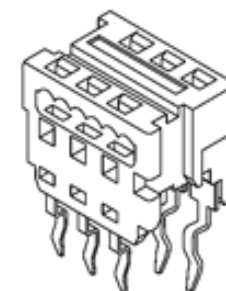

image - Reference only

Series

EU RoHS

ELV and RoHS Compliant

REACH SVHC

Contains SVHC: No

Halogen-Free

Status

Not Halogen-Free

China RoHS



Need more information on product environmental compliance?

Email productcompliance@molex.com
 For a multiple part number RoHS Certificate of Compliance, [click here](#)

Please visit the [Contact Us](#) section for any non-product compliance questions.

Search Parts in this Series

90584Series

Mates With

N/A

Application Tooling | FAQ

Tooling specifications and manuals are found by selecting the products below. Crimp Height Specifications are then contained in the Application Tooling Specification document.

Global

Description	Product #
Arbor Press Fixture	0690201902

Old Part Number

99994071

Reference - Drawing Numbers

Product Specification

ES-99033-0002, PS-99020-0011

Sales Drawing

SDA-90584

This document was generated on 03/16/2010

PLEASE CHECK WWW.MOLEX.COM FOR LATEST PART INFORMATION

90584	***26	26	(35.53)/1.399	(31.75)/1.250	(30.48)/1.200	14	98	7
	***24	24	(32.99)/1.299	(29.21)/1.150	(27.94)/1.100	15	105	
	***22	22	(30.45)/1.199	(26.67)/1.050	(25.40)/1.000	16	112	
	***20	20	(27.91)/1.099	(24.13)/.950	(22.86)/.900	18	126	
	***18	18	(25.37)/.999	(21.59)/.850	(20.32)/.800	20	140	
	***16	16	(22.83)/.899	(19.05)/.750	(17.78)/.700	23	161	
	***14	14	(20.29)/.799	(16.51)/.650	(15.24)/.600	26	182	
	***12	12	(17.75)/.699	(13.97)/.550	(12.70)/.500	30	210	
	***10	10	(15.21)/.599	(11.43)/.450	(10.16)/.400	34	238	
	***08	8	(12.67)/.499	(8.89)/.350	(7.62)/.300	42	294	
	***06	6	(10.13)/.399	(6.35)/.250	(5.08)/.200	54	378	
90584	***04	4	(7.59)/.299	(3.81)/.150	(2.54)/.100	70	490	7
PART NO.	CCT SIZE	DIMENSION A	DIMENSION B	DIMENSION C	TUBE QTY	STACK QTY	TUBES PER STACK	

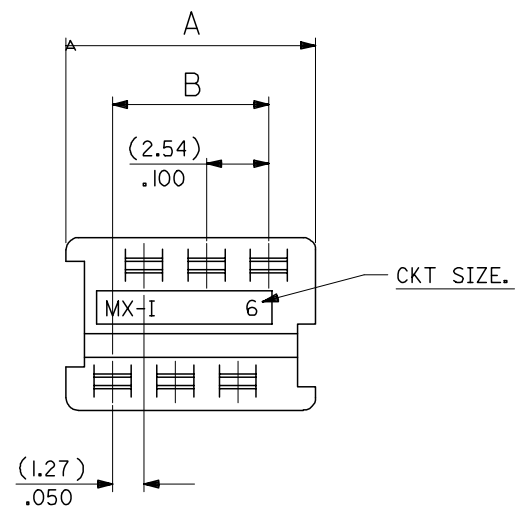

HOUSING
MATL. POLYESTER, RATED UL 94V-0, COLOUR WHITE.

IDT CONTACT
MATL : PHOSPHOR BRONZE (0.28)/.011 REF THICK.
PLATING : (2-4um) / 80-160u" TIN

- NOTES:**
- APPL. CLASS TO DIN 40040 HME (-25°C/+100°C)
 - SEE PRODUCT SPECIFICATION PS-99020-0011
 - WIRE TERMINATION SPEC : ES-99033-0002
- 90584- * * * *
04 TO 26 = CKT SIZE.
3= NO CIRCUITS VOIDED.
4= CIRCUITS 4 & 5 VOIDED.
1= INDIVIDUAL TUBED ASSY
2= STACKED TUBED ASSY - SEE SHEET 2
9= NON STANDARD OPTION - SEE SHEET 3

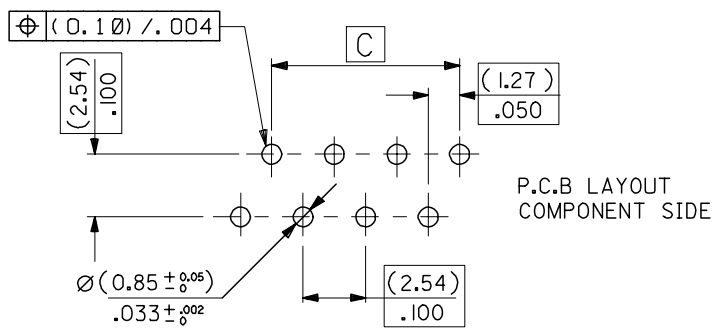
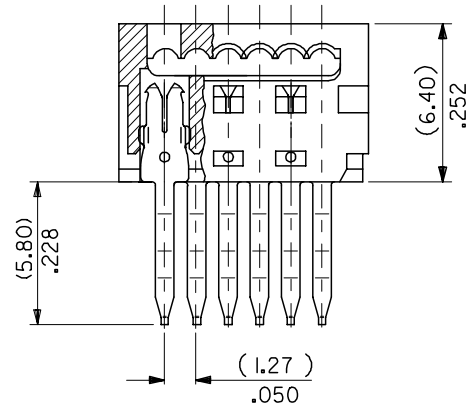
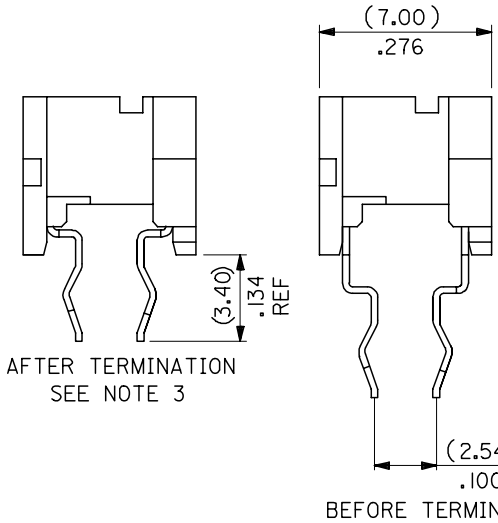

ADD VOIDED OPTION EC NO: E2005-1027 DRAWN: GMSWEN 2005/05/10 CHKD: DMORLARTY 2005/05/10 APPR: J DENNEY 2005/05/26	QUALITY SYMBOLS ▽=0 ▽=0	GENERAL TOLERANCES (UNLESS SPECIFIED)		DIMENSION STYLE MM/IN	SCALE 5:1	DESIGN UNITS METRIC	THIRD ANGLE PROJECTION
		4 PLACES ± --- ± ---	3 PLACES ± --- ± ---	2 PLACES ± 0.10 ± ---	1 PLACE ± 0.20 ± ---	ANGULAR ± 1/2°	DRAWN BY DMCNAMAR 2003/09/01
M	REV	DRAFT WHERE APPLICABLE MUST REMAIN WITHIN DIMENSIONS		APPROVED BY MWILHITE 2003/09/01	DATE 2003/09/01	MOLEX INCORPORATED	
		SEE CHART		MATERIAL NO.	DOCUMENT NO. SDA-90584	SHEET NO. 1 OF 3	

10 9 8 7 6 5 4 3 2 1

F F

E E

D D

C C

B B

A A

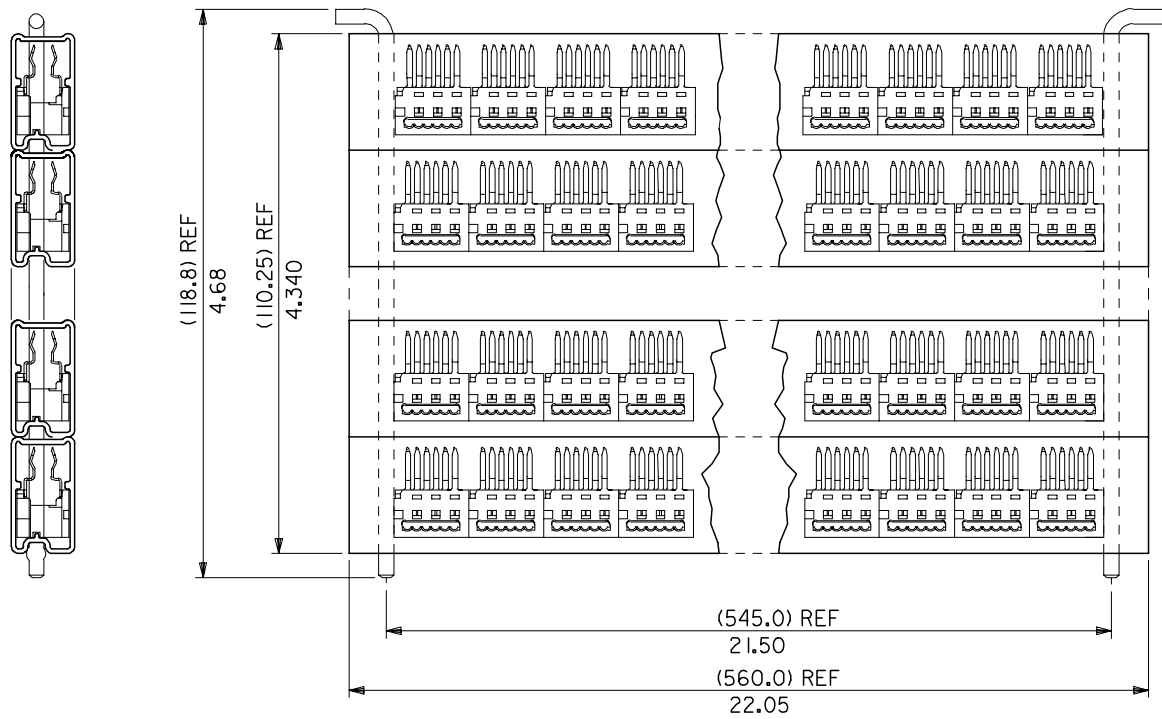

STACKED TUBED ASSEMBLY

REVISION UPDATE EC NO: E2005-1027 DRAWN:GMSWEEN 2005/05/10 CHKD:DMORIARTY 2005/05/10 APPR: JDENNEHY 2005/05/26	QUALITY SYMBOLS 	GENERAL TOLERANCES (UNLESS SPECIFIED)		DIMENSION STYLE MM/IN	SCALE NTS	DESIGN UNITS METRIC	THIRD ANGLE PROJECTION		
		4 PLACES ± --- ± ---	3 PLACES ± --- ± .010	DRAWN BY PW	DATE 1994/02/25	TITLE 1.27MM PF LOW PRO IDT BOARD-IN CONNECTOR			
		2 PLACES ± 0.25 ± ---	1 PLACE ± --- ± ---	CHECKED BY DMORIARTY	DATE 2005/05/06	MOLEX INCORPORATED			
		ANGULAR ± 2 °		APPROVED BY JDENNEHY	DATE 2005/05/10	MATERIAL NO.	DOCUMENT NO. SDA-90584	SHEET NO. 2 OF 3	
DRAFT WHERE APPLICABLE MUST REMAIN WITHIN DIMENSIONS		SEE SHEET 1		THIS DRAWING CONTAINS INFORMATION THAT IS PROPRIETARY TO MOLEX INCORPORATED AND SHOULD NOT BE USED WITHOUT WRITTEN PERMISSION					

9 8 7 6 5 4 3 2 1

10 9 8 7 6 5 4 3 2 1

90584-9001	26	(35.53)/ 1.399	(31.75)/ 1.250	(30.48)/ 1.200	12, 13, 14, 15	14	98	7
PART NO.	CCT SIZE	DIMENSION A	DIMENSION B	DIMENSION C	VOIDED POSITIONS	TUBE QTY	STACK QTY	TUBES PER STACK

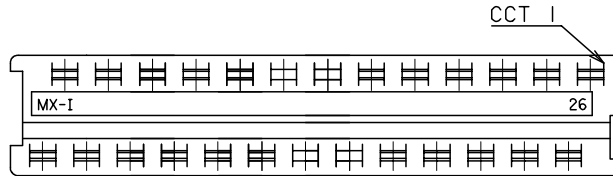

NOTES:

1. SEE SHEET ONE FOR ALL DIMENSIONS AND NOTES

NON STANDARD OPTION

REVISION UPDATE EC NO: E2005-1027 DRAWN: GMSWEEN 2005/05/10 CHKD: DMOR IARTY 2005/05/10 APPR: JDENNEHY 2005/05/26	QUALITY SYMBOLS ▽=0 ▽=0	GENERAL TOLERANCES (UNLESS SPECIFIED)		DIMENSION STYLE MM/IN		SCALE 5:1	DESIGN UNITS METRIC	THIRD ANGLE PROJECTION		
						DRAWN BY KD		DATE 2001/01/31		TITLE 1.27MM PF LOW PRO IDT BOARD-IN CONNECTOR
						CHECKED BY DMOR IARTY		DATE 2005/05/06		
						APPROVED BY JDENNEHY		DATE 2005/05/10		MOLEX INCORPORATED
		DRAFT WHERE APPLICABLE MUST REMAIN WITHIN DIMENSIONS		SEE CHART		DOCUMENT NO. SDA-90584		SHEET NO. 3 OF 3		

9 8 7 6 5 4 3 2 1