



Frontier Electronics Corp.

667 E. COCHRAN STREET, SIMI VALLEY, CA 93065

TEL: (805) 522-9998 FAX: (805) 522-9989

E-mail: frontiersales@frontierusa.com

Web: <http://www.frontierusa.com>

1A FAST RECOVERY GLASS PASSIVATED RECTIFIER

FR10-005G-LFR THRU FR10-10G-LFR

FEATURES

- FAST RECOVERY TIMES
- UL 94V0 FLAME RETARDANT EPOXY MOLDING COMPOUND
- GLASS PASSIVATED CHIP JUNCTION
- LOW COST
- HIGH SURGE CURRENT CAPABILITY
- ROHS

MECHANICAL DATA

- CASE: TRANSFER MOLDED, DO41, DIMENSIONS IN INCHES AND (MILLIMETERS)
- LEADS: SOLDERABLE PER MIL-STD-202, METHOD 208
- POLARITY: CATHODE INDICATED BY COLOR BAND
- WEIGHT: 0.34 GRAMS

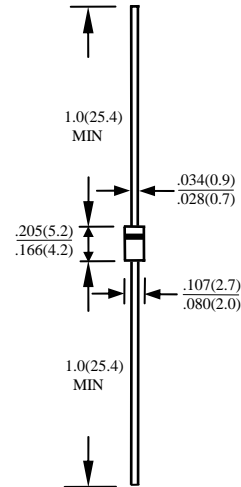

MAXIMUM RATINGS AND ELECTRICAL CHARACTERISTICS RATINGS AT 25°C AMBIENT TEMPERATURE UNLESS OTHERWISE SPECIFIED SINGLE PHASE, HALF WAVE, 60 HZ, RESISTIVE OR INDUCTIVE LOAD. FOR CAPACITIVE LOAD, DERATE CURRENT BY 20%

RATINGS	SYMBOL	FR10-005G-LFR	FR10-01G-LFR	FR10-02G-LFR	FR10-04G-LFR	FR10-06G-LFR	FR10-08G-LFR	FR10-10G-LFR	UNITS
MAXIMUM RECURRENT PEAK REVERSE VOLTAGE	V_{RRM}	50	100	200	400	600	800	1000	V
MAXIMUM RMS VOLTAGE	V_{RMS}	35	70	140	280	420	560	700	V
MAXIMUM DC BLOCKING VOLTAGE	V_{DC}	50	100	200	400	600	800	1000	V
MAXIMUM AVERAGE FORWARD RECTIFIED CURRENT 0.375" (9.5mm) LEAD LENGTH AT $T_A=55^\circ\text{C}$	I_O	1.0							A
PEAK FORWARD SURGE CURRENT, 8.3ms SINGLE HALF SINE-WAVE SUPERIMPOSED ON RATED LOAD	I_{FSM}	30							A
TYPICAL JUNCTION CAPACITANCE (NOTE 1)	C_J	15							PF
TYPICAL THERMAL RESISTANCE (NOTE 2)	$R_{\theta jc}$	50							$^\circ\text{C/W}$
STORAGE TEMPERATURE RANGE	T_{STG}	- 55 TO + 150							$^\circ\text{C}$
OPERATING TEMPERATURE RANGE	T_{OP}	- 55 TO + 150							$^\circ\text{C}$

ELECTRICAL CHARACTERISTICS ($A_T T_A = 25^\circ\text{C}$ UNLESS OTHERWISE NOTED)

CHARACTERISTICS	SYMBOL	FR10-005G-LFR	FR10-01G-LFR	FR10-02G-LFR	FR10-04G-LFR	FR10-06G-LFR	FR10-08G-LFR	FR10-10G-LFR	UNITS
MAXIMUM FORWARD VOLTAGE AT I_O DC	V_F	1.3							V
MAXIMUM REVERSE CURRENT AT 25°C	I_R	5							μA
MAXIMUM REVERSE CURRENT AT 100°C	I_R	50							μA
MAXIMUM REVERSE RECOVERY TIME (NOTE 3)	T_{RR}	150			250		500		nS

- NOTE:
1. MEASURED AT 1 MHZ AND APPLIED REVERSE VOLTAGE OF 4.0 VOLTS
 2. BOTH LEADS ATTACHED TO HEAT SINK 20x20x1t(mm) COPPER PLATE AT LEAD LENGTH 5mm
 3. REVERSE RECOVERY TEST CONDITIONS: $I_F=0.5\text{A}$, $I_R=1.0\text{A}$, $I_{RR}=0.25\text{A}$

RATINGS AND CHARACTERISTIC CURVE FR10-005G-LFR THRU FR10-10G-LFR

FIG. 1-TEST CIRCUIT DIAGRAM AND REVERSE RECOVERY TIME CHARACTERISTIC

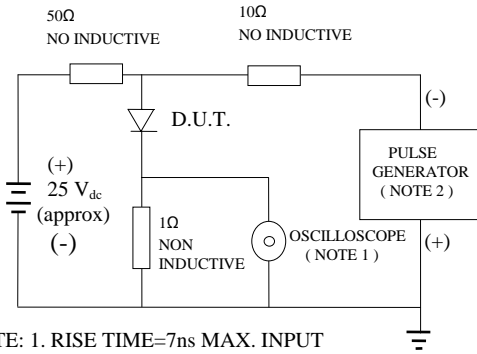

NOTE: 1. RISE TIME=7ns MAX. INPUT IMPEDANCE=1 MOhms 22PF
 2. RISE TIME =10ns MAX. SOURCE IMPEDANCE=50 OHMS

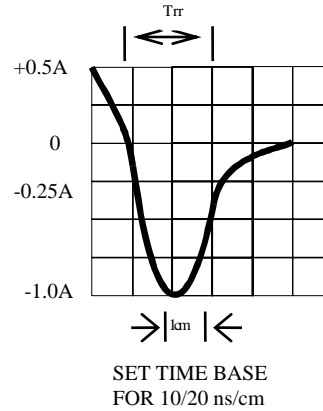

Fig. 2-MAXIMUM FORWARD CURRENT DERATING CURVE

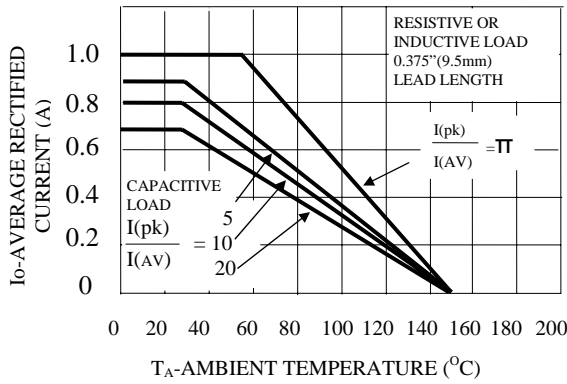

FIG. 3-TYPICAL JUNCTION CAPACITANCE

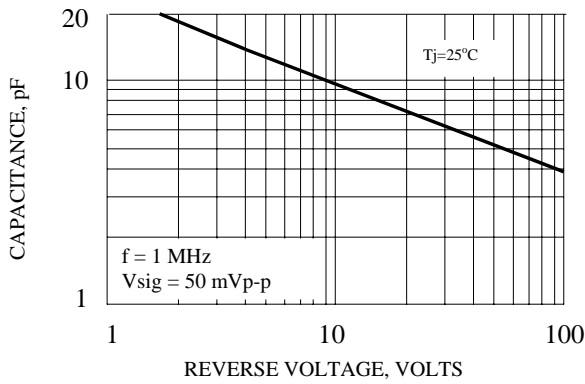

FIG. 4-TYPICAL REVERSE CHARACTERISTICS

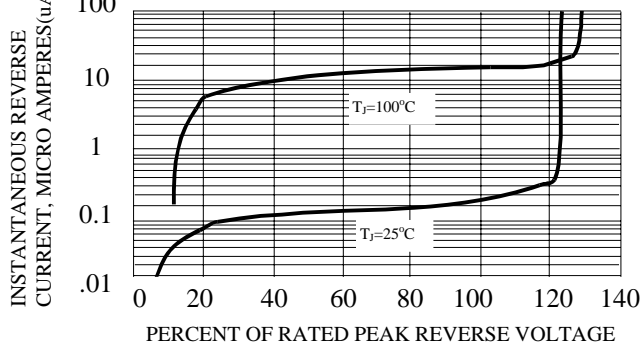

Fig. 5-MAXIMUM FORWARD SURGE CURRENT

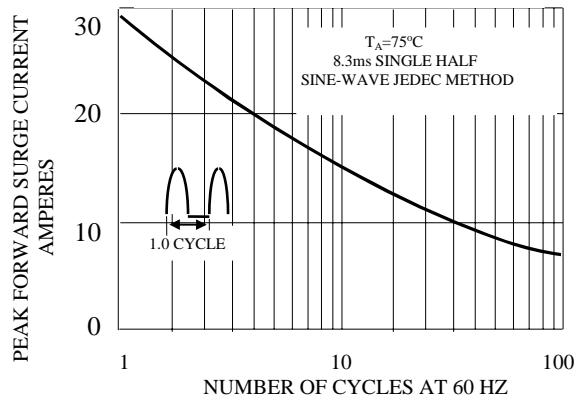

FIG. 6-TYPICAL INSTANTANEOUS FORWARD CHARACTERISTICS

