



Technical Data Sheet  
3mm 1Pcs Circuit Board Indicator

A274B/SYG/S530-E2

■ Features :

- Low power consumption
- High efficiency and low cost
- Good control and free combinations on the colors of LED lamps
- Good lock and easy to assembly
- Stackable and easy to assembly  
Stackable vertically and easy to assembly
- Versatile mounting on P.C board or panel
- Stackable horizontally and easy to assembly
- Pb free

■ Descriptions :

- ARRAY=Plastic Holder+Combinations of Lamps
- The array will easily mount the applicable lamps on any panel up to

■ Applications :

- 1.Used as indicators of indicating the Degree, Functions, Positions etc, in electronic instruments.

| PART NO.           | Chip     |                    | Lens Color     |
|--------------------|----------|--------------------|----------------|
|                    | Material | Emitted Color      |                |
| 264-10SYGD/S530-E2 | AlGaInP  | Super Yellow Green | Green Diffused |

Technical Data Sheet  
 3mm 1Pcs Circuit Board Indicator

A274B/SYG/S530-E2

## Package Dimensions

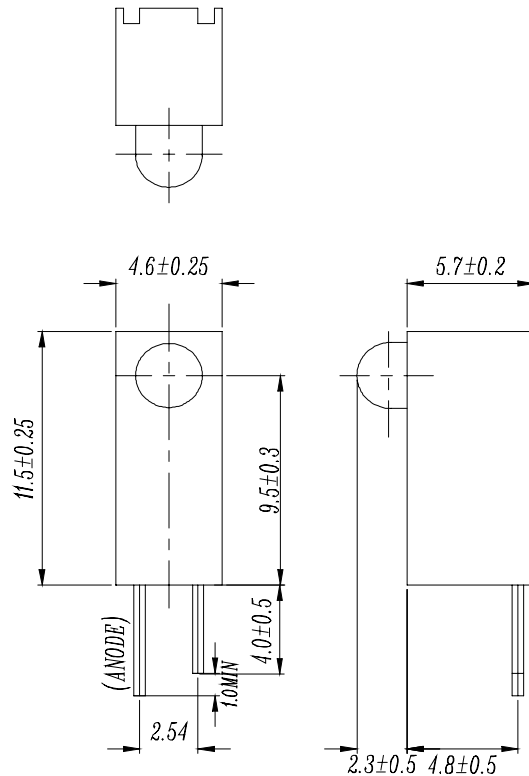

Notes: 1.All dimensions are in millimeters, tolerance is 0.25mm except being specified  
 2.Lead spacing is measured where the lead emerge from the package

 Absolute Maximum Ratings at  $T_a = 25^\circ\text{C}$ 

| Parameter               | Symbol    | Rating      | Unit             |
|-------------------------|-----------|-------------|------------------|
| Forward Current         | $I_F$     | 25          | mA               |
| Operating Temperature   | $T_{opr}$ | -40 to +85  | $^\circ\text{C}$ |
| Storage Temperature     | $T_{stg}$ | -40 to +100 | $^\circ\text{C}$ |
| Soldering Temperature   | $T_{sol}$ | $260 \pm 5$ | $^\circ\text{C}$ |
| Electrostatic Discharge | ESD       | 2000        | V                |
| Power Dissipation       | $P_d$     | 60          | mW               |
| Reverse Voltage         | $V_R$     | 5           | V                |

Note: \*1:Soldering time  $\leq 5$  seconds.



## Technical Data Sheet

## 3mm 1Pcs Circuit Board Indicator

A274B/SYG/S530-E2

Electro-Optical Characteristics(Ta=25°C)

| Parameter                    | Symbol         | Condition              | Min. | Typ. | Max. | Unit |
|------------------------------|----------------|------------------------|------|------|------|------|
| Forward Voltage              | V <sub>F</sub> | I <sub>F</sub> = 20 mA | /    | 2.0  | 2.4  | V    |
| Reverse Current              | I <sub>R</sub> | V <sub>R</sub> = 5 V   | /    | /    | 10   | μA   |
| Luminous Intensity           | I <sub>v</sub> | I <sub>F</sub> = 20 mA | 25   | 50   | /    | mcd  |
| Viewing Angle                | 2θ 1/2         | I <sub>F</sub> = 20 mA | /    | 60   | /    | deg  |
| Peak Wavelength              | λ <sub>p</sub> | I <sub>F</sub> = 20 mA | /    | 575  | /    | nm   |
| Dominant Wavelength          | λ <sub>d</sub> | I <sub>F</sub> = 20 mA | /    | 573  | /    | nm   |
| Spectrum Radiation Bandwidth | Δλ             | I <sub>F</sub> = 20 mA | /    | 20   | /    | nm   |

Technical Data Sheet  
3mm 1Pcs Circuit Board Indicator

A274B/SYG/S530-E2

■ Typical Electro-Optical Characteristic Curves:

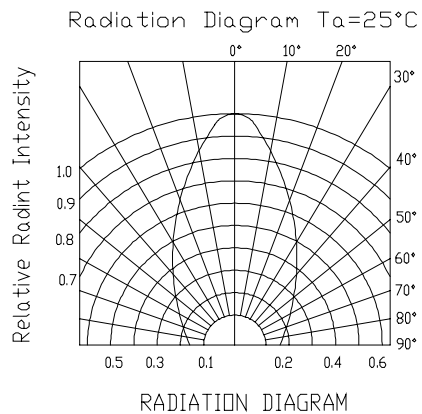
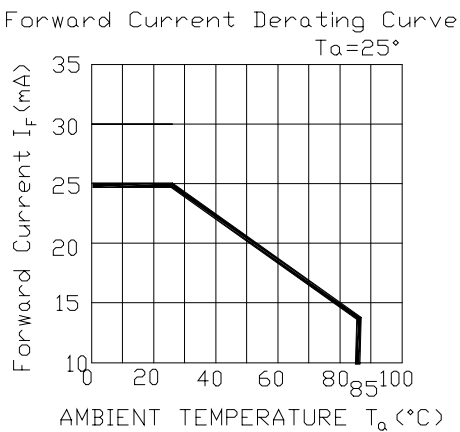
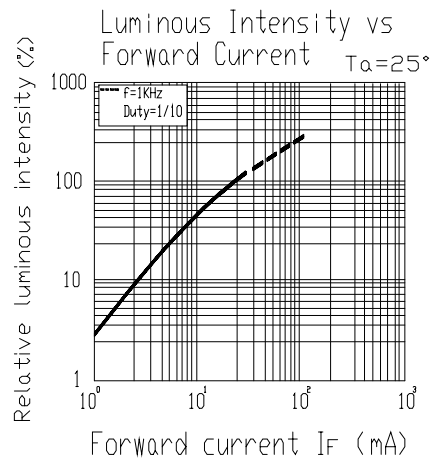
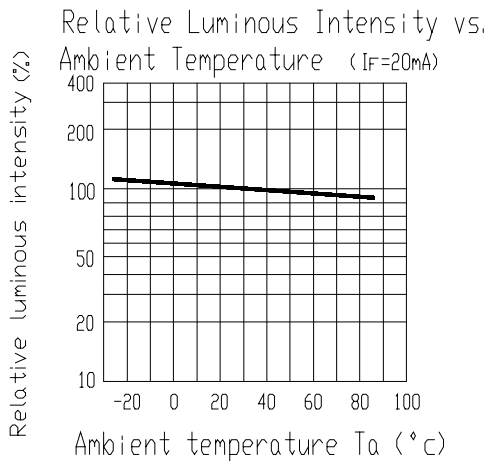
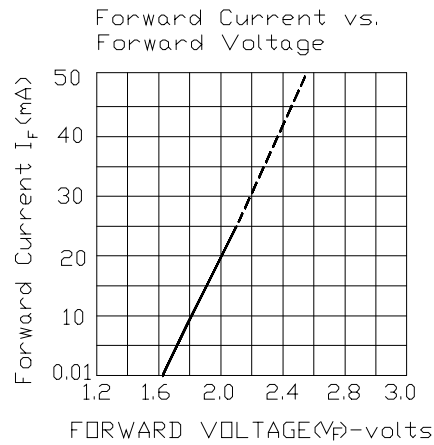
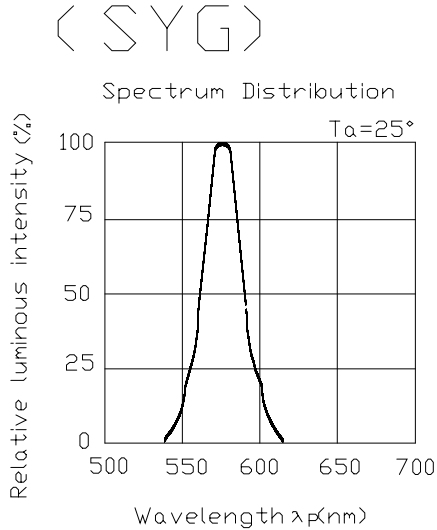



# Technical Data Sheet

## 3mm 1Pcs Circuit Board Indicator

A274B/SYG/S530-E2

### ■ Reliability test items and conditions:

The reliability of products shall be satisfied with items listed below.

Confidence level : 97%

LTPD : 3%

| NO | Item                             | Test Conditions                                     | Test Hours/Cycle | Sample Size | Failure Judgment Criteria   | Ac/Re |
|----|----------------------------------|---|------------------|-------------|---|-------|
| 1  | Solder Heat                      | TEMP : 260°C ± 5 °C                                 | 10 SEC           | 76 PCS      | $I_v \leq I_{vt} * 0.5$<br>or<br>$V_f \geq U$<br>or<br>$V_f \leq L$ | 0/1   |
| 2  | Temperature Cycle                | H : +100°C 15min<br>$\int$ 5 min<br>L : -40°C 15min | 300 CYCLES       | 76 PCS      |   | 0/1   |
| 3  | Thermal Shock                    | H : +100°C 5min<br>$\int$ 10 sec<br>L : -10°C 5min  | 300 CYCLES       | 76 PCS      |   | 0/1   |
| 4  | High Temperature Storage         | TEMP : 100°C  | 1000 HRS         | 76 PCS      |   | 0/1   |
| 5  | Low Temperature Storage          | TEMP : -40°C  | 1000 HRS         | 76 PCS      |   | 0/1   |
| 6  | DC Operating Life                | TEMP : 25°C<br>IF = 20mA                            | 1000 HRS         | 76 PCS      |   | 0/1   |
| 7  | High Temperature / High Humidity | 85°C / 85% RH                                       | 1000 HRS         | 76 PCS      |   | 0/1   |

Note :  $I_{vt}$  : To test  $I_v$  value of the chip before the reliability test

$I_v$  : The test value of the chip that has completed the reliability test

U : Upper Specification Limit

L : Lower Specification Limit



Technical Data Sheet  
3mm 1Pcs Circuit Board Indicator

A274B/SYG/S530-E2

Packing Quantity Specification

- 1.500PCS/1Bag · 4Bags/1Box
- 2. 10Boxes/1Carton

Label Form Specification



CPN: Customer's Production Number  
P/N : Production Number  
QTY: Packing Quantity  
CAT: Ranks  
HUE: Dominant Wavelength  
REF: Reference  
LOT No: Lot Number  
MADE IN TAIWAN: Production Place

Notes

1. Above specification may be changed without notice. EVERLIGHT will reserve authority on material change for above specification.
2. When using this product, please observe the absolute maximum ratings and the instructions for using outlined in these specification sheets. EVERLIGHT assumes no responsibility for any damage resulting from use of the product which does not comply with the absolute maximum ratings and the instructions included in these specification sheets.
3. These specification sheets include materials protected under copyright of EVERLIGHT corporation.

Please don't reproduce or cause anyone to reproduce them without EVERLIGHT's consent.

|  |   |
|--|---|
| <i>EVERLIGHT ELECTRONICS CO., LTD.</i>               | <i>Tel: (886-2-2267-2000, 2267-9936</i>         |
| <i>Office: No 25, Lane 76, Sec 3, Chung Yang Rd,</i> | <i>Fax: 886-2267-6244, 2267-6189, 2267-6306</i> |
| <i>Tucheng, Taipei 236, Taiwan, R.O.C</i>            | <i>http://www.everlight.com</i>                 |