

# Spezifikation für Freigabe / specification for release

Kunde / customer :  
 Artikelnummer / part number : **7443630140**  
 Bezeichnung : **SPEICHERDROSSEL WE-HCF 2013**  
 description : **POWER-CHOKE WE-HCF 2013**



DATUM / DATE : 2009-07-07

## A Mechanische Abmessungen / dimensions:

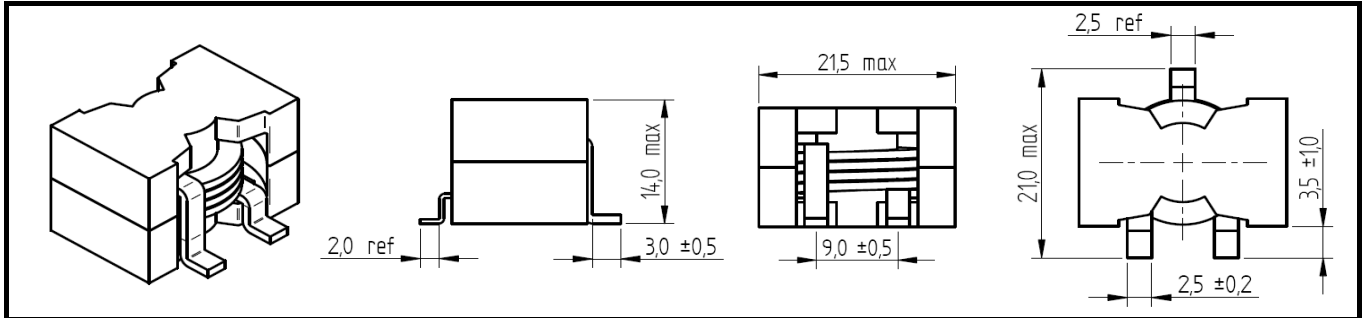

Marking = part number

## B Elektrische Eigenschaften / electrical properties:

Eigenschaften / properties	Testbedingungen / test conditions		Wert / value	Einheit / unit	tol.
Lerrlaufinduktivität / initial inductance	100 kHz / 10mA	$L_0$	1,40	$\mu\text{H}$	$\pm 15\%$
DC-Widerstand / DC-resistance	@ 20° C	$R_{DC}$	1,08	$\text{m}\Omega$	$\pm 10\%$
Nennstrom / rated current	$\Delta T = 50 \text{ K}$	$I_N$	31,5	A	typ.
Sättigungsstrom / saturation current	$\Delta L/L_0 = 30 \%$	$I_{sat}$	60,0	A	typ.
Eigenres.-Frequenz / self-res.-frequency		SRF	52,0	MHz	typ.

## C Lötpad / soldering spec.:

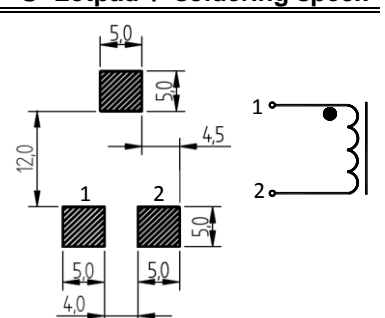

## D Prüfgeräte / test equipment:

WAYNE KERR 3260B für/for  $L_0$ ;  $I_{SAT}$   
 HP 34401 A & Fluke 5411 für/for  $I_{DC}$ ;  
 Metra HIT 271 für/for  $R_{DC}$

## E Testbedingungen / test conditions:

Luftfeuchtigkeit / humidity: 33%  
 Umgebungstemperatur / temperature: +20°C

## F Werkstoffe & Zulassungen / material & approvals:

Basismaterial / base material: Ferrite  
 Draht / wire: Class F

## G Eigenschaften / general specifications:

Arbeitstemperatur / operating temperature: -40°C - +125°C  
 Umgebungstemp. / ambient temperature: -40°C - +85°C  
 It is recommended that the temperature of the part does not exceed 125°C under worst case operating conditions.

Freigabe erteilt / general release:	Kunde / customer			
Datum / date	Unterschrift / signature			
	Würth Elektronik			
Geprüft / checked	Kontrolliert / approved	Rst	Version 1	09-07-07
		Name	Änderung / modification	Datum / date

### Würth Elektronik eiSos GmbH & Co. KG

D-74638 Waldenburg · Max-Eyth-Strasse 1 - 3 · Germany · Telefon (+49) (0) 7942 - 945 - 0 · Telefax (+49) (0) 7942 - 945 - 400  
<http://www.we-online.de>

# Spezifikation für Freigabe / specification for release

Kunde / customer :  
 Artikelnummer / part number : **7443630140**  
 Bezeichnung : **SPEICHERDROSSEL WE-HCF 2013**  
 description : **POWER-CHOKE WE-HCF 2013**



DATUM / DATE : 2009-07-07

## H Induktivitätskurve / Inductance curve:

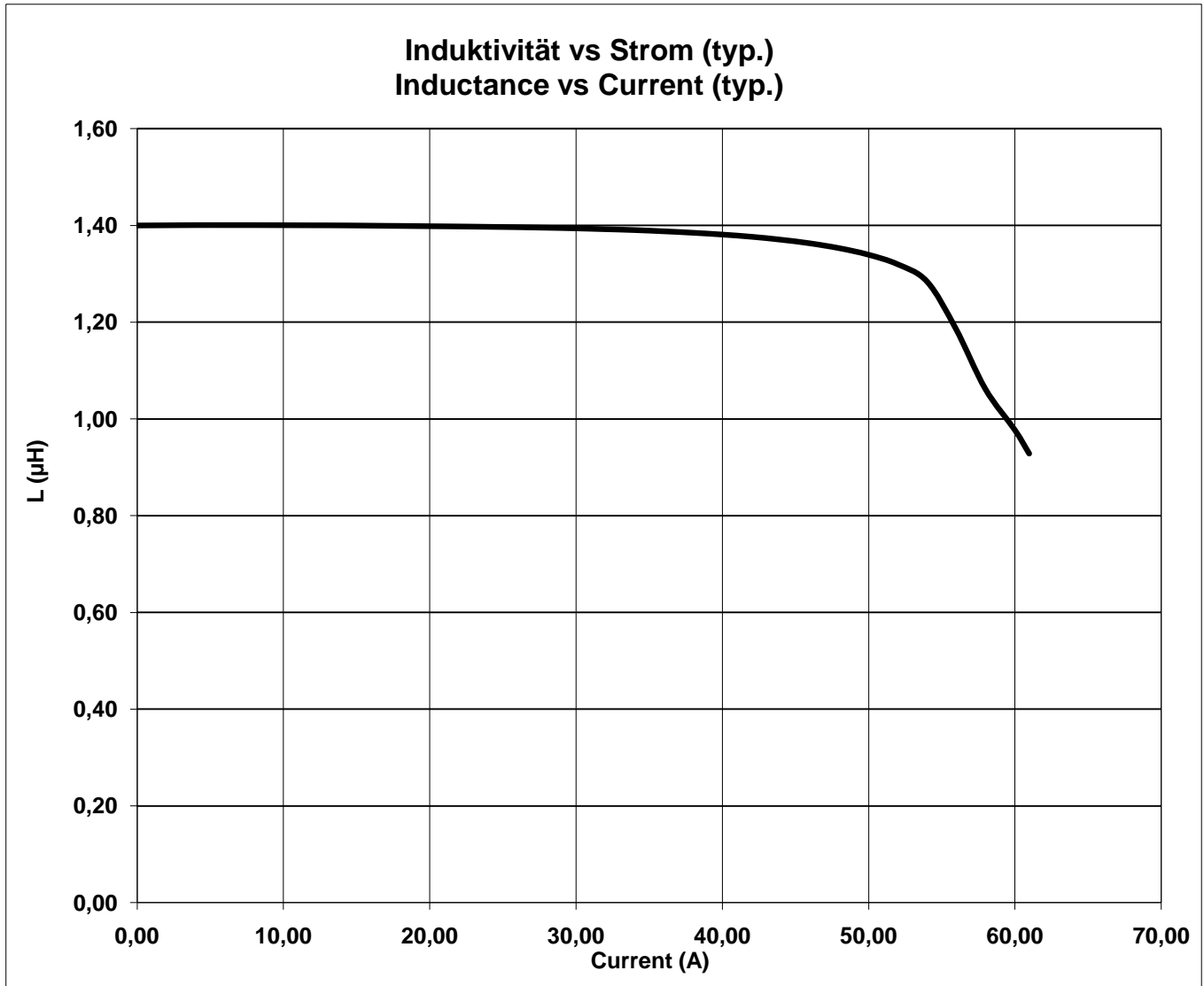

Freigabe erteilt / general release:	Kunde / customer			
.....	.....			
Datum / date	Unterschrift / signature			
	Würth Elektronik			
.....	.....			
Geprüft / checked	Kontrolliert / approved	Rst	Version 1	09-07-07
		Name	Änderung / modification	Datum / date

**Würth Elektronik eiSos GmbH & Co. KG**

D-74638 Waldenburg · Max-Eyth-Strasse 1 - 3 · Germany · Telefon (+49) (0) 7942 - 945 - 0 · Telefax (+49) (0) 7942 - 945 - 400  
<http://www.we-online.de>

# Spezifikation für Freigabe / specification for release

Kunde / customer :  
 Artikelnummer / part number : **7443630140**  
 Bezeichnung : **SPEICHERDROSSEL WE-HCF 2013**  
 description : **POWER-CHOKE WE-HCF 2013**

LF



DATUM / DATE : 2009-07-07

## I Temperaturanstieg / Temperature rise curve:

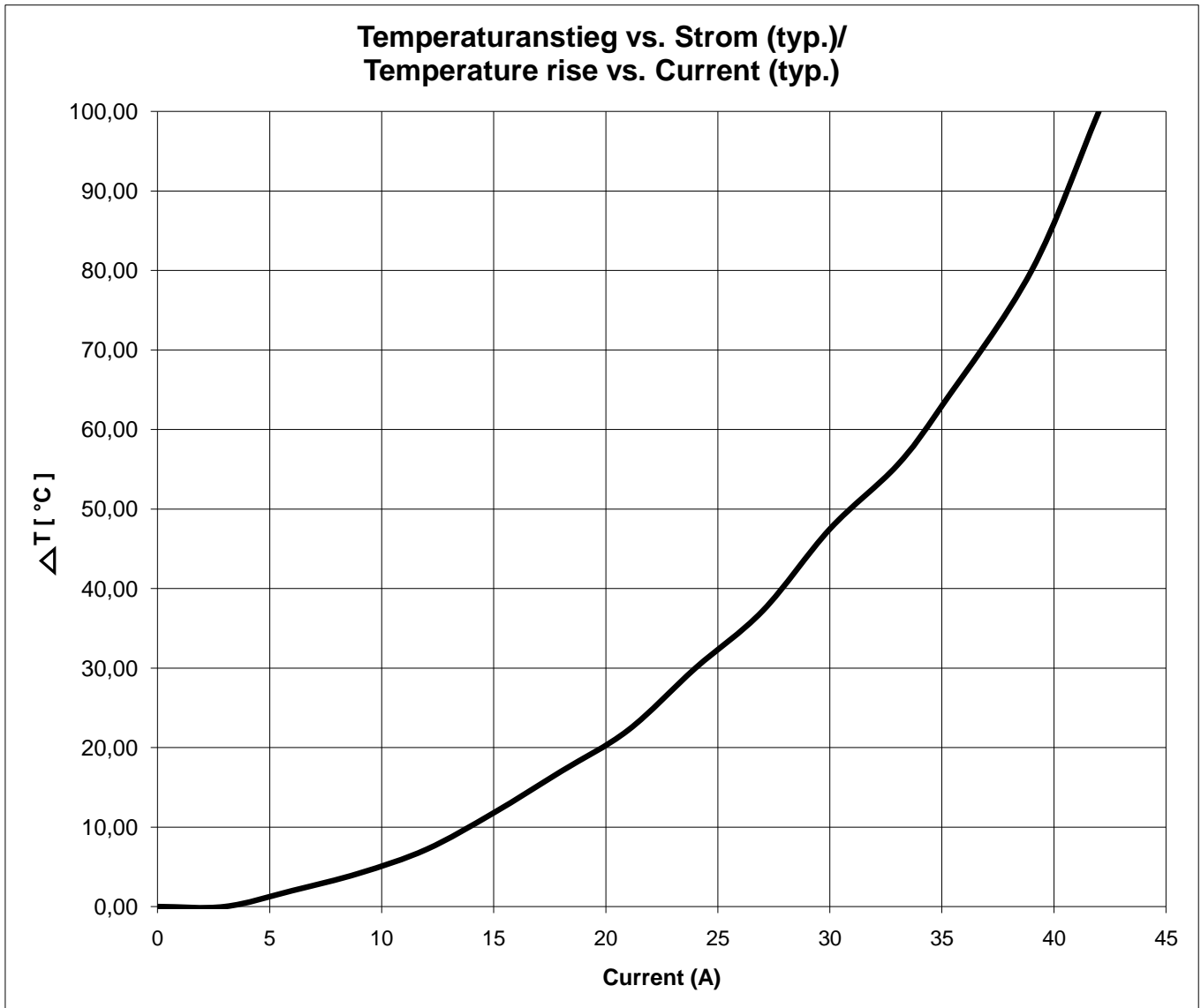

Freigabe erteilt / general release:	<b>Kunde / customer</b>			
.....	.....			
Datum / date	Unterschrift / signature			
.....	<b>Würth Elektronik</b>			
.....	.....			
Geprüft / checked	Kontrolliert / approved	Rst	Version 1	09-07-07
.....	.....	Name	Änderung / modification	Datum / date

**Würth Elektronik eiSos GmbH & Co. KG**

D-74638 Waldenburg · Max-Eyth-Strasse 1 - 3 · Germany · Telefon (+49) (0) 7942 - 945 - 0 · Telefax (+49) (0) 7942 - 945 - 400  
<http://www.we-online.de>

# Spezifikation für Freigabe / specification for release

Kunde / customer :  
 Artikelnummer / part number : **7443630140**  
 Bezeichnung : **SPEICHERDROSSEL WE-HCF 2013**  
 description : **POWER-CHOKE WE-HCF 2013**

LF



DATUM / DATE : 2009-07-07

**J Rollenspezifikation / tape and reel specification:**

Gurtspezifikation / Tape specification:

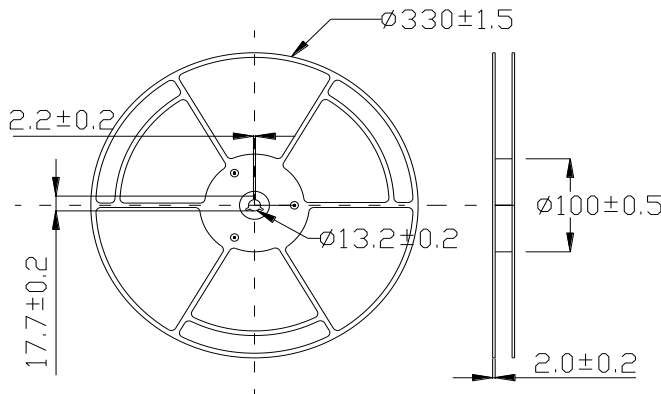
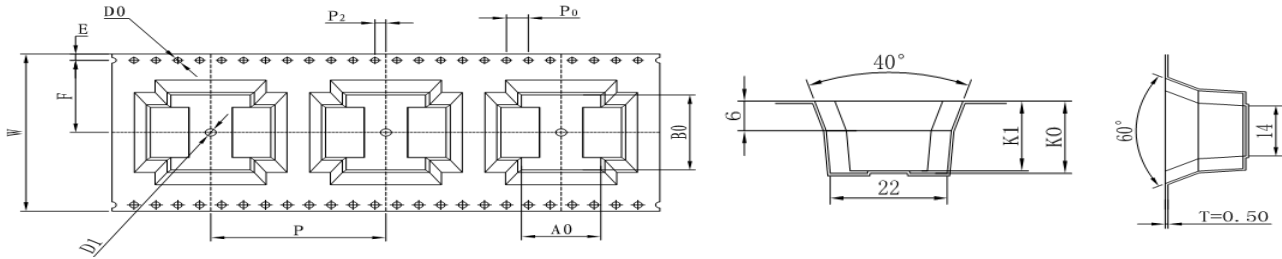

A0	14.5±0.1
B0	21.0±0.1
K0	14.6±0.1
P0	4.0±0.1
P	32.0±0.1
P2	2.0±0.1
E	1.75±0.10
F	20.20±0.10
D0	ψ1.5+0.1-0.0
D1	ψ2.0
W	44.0±0.3
T	0.50±0.05

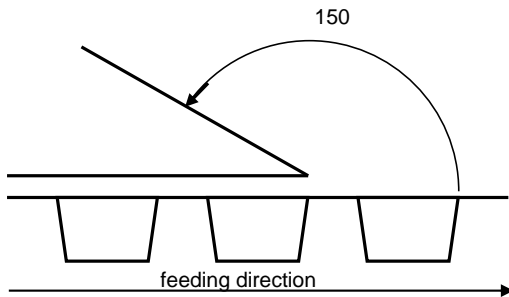

The Force for tearing off cover tape is 20 to 70 grams in arrow direction

Freigabe erteilt / general release:	Kunde / customer			
	Datum / date	Unterschrift / signature		
	Würth Elektronik			
	Kontrolliert / approved	Rst	Version 1	09-07-07
Geprüft / checked		Name	Änderung / modification	Datum / date

This electronic component has been designed and developed for usage in general electronic equipment. Before incorporating this component into any equipment where higher safety and reliability is especially required or if there is the possibility of direct damage or injury to human body, for example in the range of aerospace, aviation, nuclear control, submarine, transportation, (automotive control, train control, ship control), transportation signal, disaster prevention, medical, public information network etc, Würth Elektronik eiSos GmbH must be informed before the design-in stage. In addition, sufficient reliability evaluation checks for safety must be performed on every electronic component which is used in electrical circuits that require high safety and reliability functions or performance.

## Würth Elektronik eiSos GmbH & Co. KG

D-74638 Waldenburg · Max-Eyth-Strasse 1 - 3 · Germany · Telefon (+49) (0) 7942 - 945 - 0 · Telefax (+49) (0) 7942 - 945 - 400  
<http://www.we-online.com>