

# SAW Bandpass Filter 205203B



## 1. Features

- IF Bandpass Filter
- Single-Ended Operation
- Ceramic Surface Mount Device (SMD) Package
- Maximum Storage Temperature Range : -40 °C ~ 85 °C
- Electrostatics Sensitive Device (ESD)

## 2. Package Dimensions

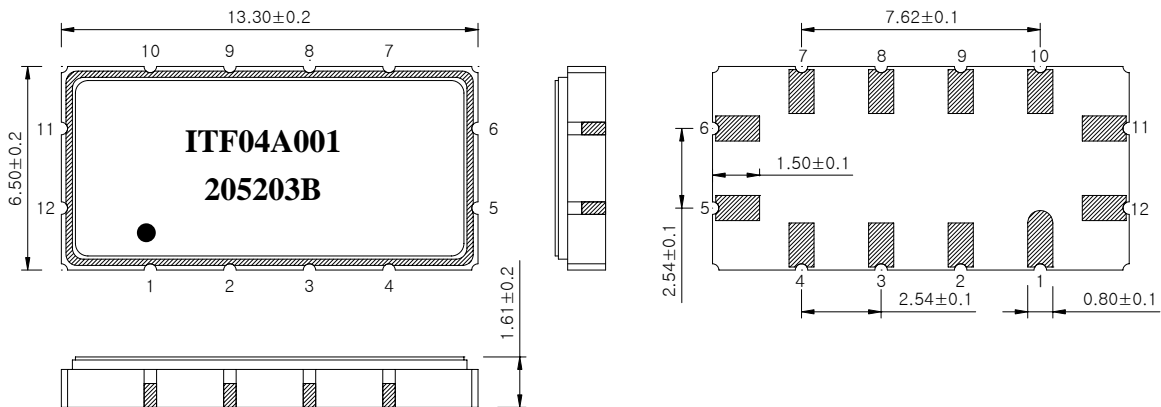

**Package : S1365**

Dimensions shown are nominal in millimeters

Body : Al<sub>2</sub>O<sub>3</sub> Ceramic

Lid : Kovar, Ni Plated

Terminations : Au plating 0.3 ~ 1.0 um, Over a 1.27 ~ 8.89 um Ni Plating

Pad Configuration	
11	Input
5	Output
6, 12	Ground
Other	Case ground



**ITF Co., Ltd.**  
 102-901, Bucheon Technopark 364,  
 Samjeong-Dong, Ojeong-Gu, Bucheon-City,  
 Gyeonggi-Do, Korea 421-809

Part No.	205203B	
Rev. Date	2004-04-28	
Rev.	NI2008-CS02	1/5

# SAW Bandpass Filter 205203B



## 3. Specifications

Fo = 65.0 MHz

Terminating source impedance : 50Ω and matching network

Terminating load impedance : 50Ω and matching network

		Minimum	Typical	Maximum
Center Frequency	MHz	-	65.0	-
Insertion Loss	dB	-	21.5	23.5
1dB Bandwidth	MHz	-	19.5	-
3dB Bandwidth	MHz	19.7	20.1	-
40dB Bandwidth	MHz	-	22.9	23.2
Amplitude Ripple (Fo +/- 9.375 MHz)	dB	-	0.7	1.0
Group Delay Variation (Fo +/- 9.375 MHz)	nsec	-	40	120
Absolute Delay	usec	-	1.33	-
Ultimate Rejection	dB	40	45	-
Temperature Coefficient of Frequency	ppm/°C	-	-86	-

### Notes :

- 1) All specifications are based on the matching schematic shown below
- 2) All specifications are measured by Agilent Network analyzer and full 2 port calibration at room temperature
- 3) All attenuation measurements are measured relative to insertion loss

 Integrated Technology Future	<b>ITF Co., Ltd.</b> 102-901, Bucheon Technopark 364, Samjeong-Dong, Ojeong-Gu, Bucheon-City, Gyeonggi-Do, Korea 421-809	Part No.	205203B	
		Rev. Date	2004-04-28	
		Rev.	NI2008-CS02	2/5

# SAW Bandpass Filter 205203B



## 4. Matching Schematic

( Actual matching values may vary due to PCB layout and parasitics )

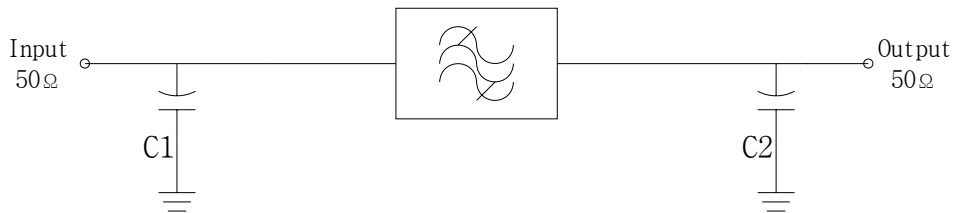

C1 = 10 pF,

C2 = 10 pF

## 5. Marking Configuration

ITF<sup>1)</sup> 04A001<sup>2)</sup>

205203B<sup>3)</sup>

●<sup>4)</sup>

1) Manufacturer name

2) Lot Number

3) Part Number

4) Pad Number 1 Index

 Integrated Technology Future	<b>ITF Co., Ltd.</b> 102-901, Bucheon Technopark 364, Samjeong-Dong, Ojeong-Gu, Bucheon-City, Gyeonggi-Do, Korea 421-809	Part No.	205203B	
		Rev. Date	2004-04-28	
		Rev.	NI2008-CS02	3/5

# SAW Bandpass Filter 205203B



## 6. Typical Performance ( at +25°C )

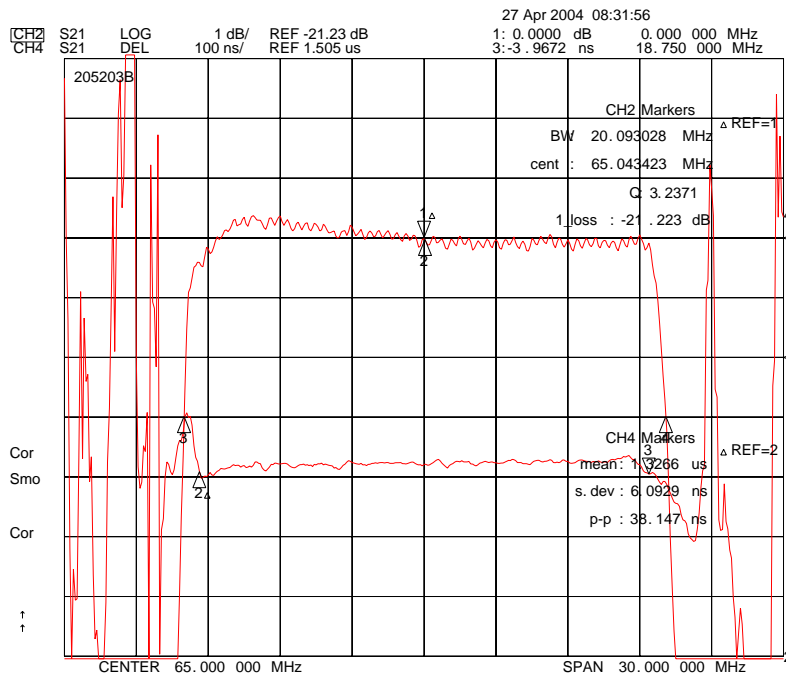
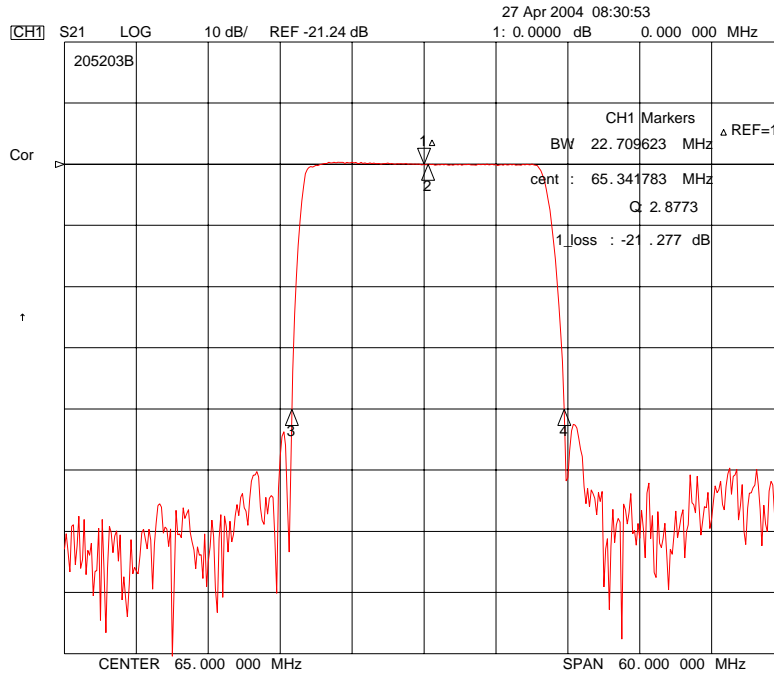

**ITF Co., Ltd.**  
 102-901, Bucheon Technopark 364,  
 Samjeong-Dong, Ojeong-Gu, Bucheon-City,  
 Gyeonggi-Do, Korea 421-809

Part No. 205203B

Rev. Date 2004-04-28

Rev. NI2008-CS02 4/5

# SAW Bandpass Filter 205203B

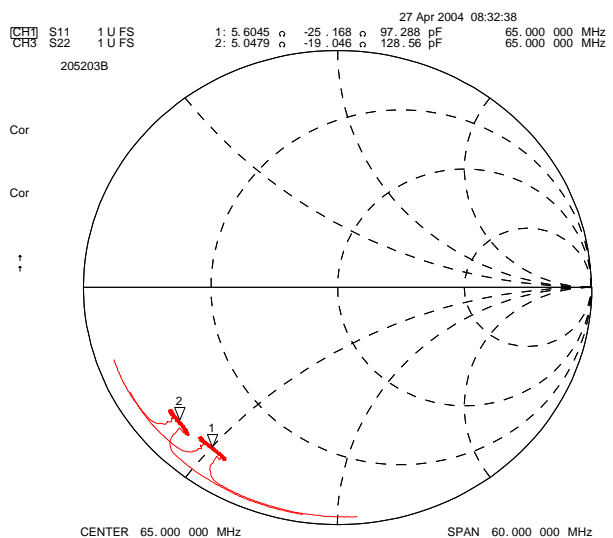
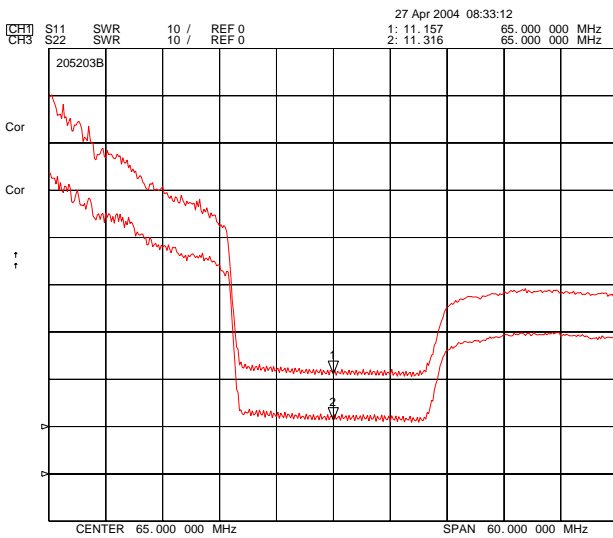
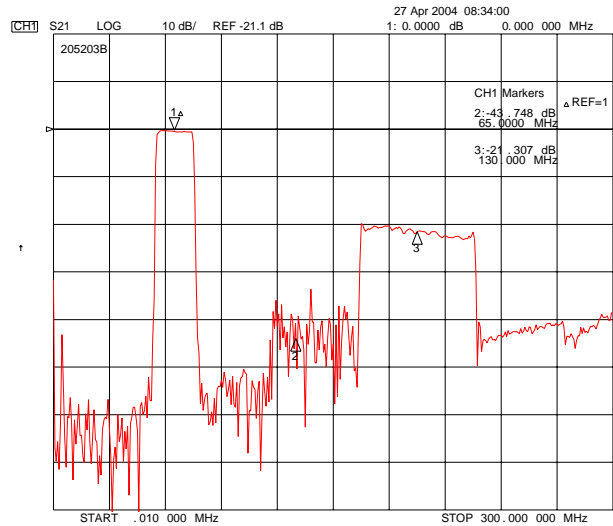
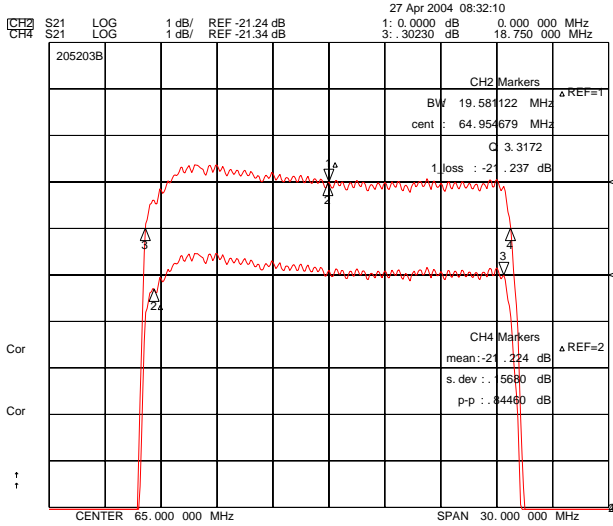

**ITF Co., Ltd.**  
 102-901, Bucheon Technopark 364,  
 Samjeong-Dong, Ojeong-Gu, Bucheon-City,  
 Gyeonggi-Do, Korea 421-809

Part No.	205203B	
Rev. Date	2004-04-28	
Rev.	NI2008-CS02	5/5