

The RF MOSFET Line
RF Power
Field Effect Transistors
N-Channel Enhancement Mode MOSFETs

Designed primarily for wideband large-signal output and driver from 30–500 MHz.

- MRF166C — Guaranteed Performance at 500 MHz, 28 Vdc
Output Power = 20 W
Gain = 13.5 dB
Efficiency = 50%
- Replacement for Industry Standards such as MRF136, DV2820, BLF244, SD1902, and ST1001
- 100% Tested for Load Mismatch at all Phase Angles with 30:1 VSWR
- Facilitates Manual Gain Control, ALC and Modulation Techniques
- Excellent Thermal Stability, Ideally Suited for Class A Operation
- Low C_{rss} — 4.0 pF @ $V_{DS} = 28$ V
- Circuit board photomaster available upon request by contacting RF Tactical Marketing in Phoenix, AZ.
- S-Parameters Available for Download into Frequency Domain Simulators.
See <http://mot-sps.com/rf/designtds/>

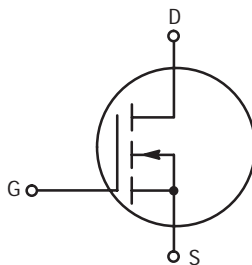

MRF166C

20 W, 500 MHz
MOSFET
BROADBAND
RF POWER FETs

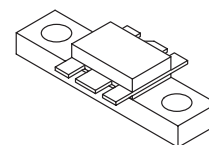

CASE 319-07, STYLE 3

MAXIMUM RATINGS

Rating	Symbol	Value	Unit
Drain–Gate Voltage	V_{DSS}	65	Vdc
Drain–Gate Voltage ($R_{GS} = 1.0$ M Ω)	V_{DGR}	65	Vdc
Gate–Source Voltage	V_{GS}	± 20	Adc
Drain Current — Continuous	I_D	4.0	Adc
Total Device Dissipation @ $T_C = 25^\circ\text{C}$ Derate Above 25°C	P_D	70 0.4	Watts W/ $^\circ\text{C}$
Storage Temperature Range	T_{stg}	–65 to 150	$^\circ\text{C}$
Operating Junction Temperature	T_J	200	$^\circ\text{C}$

THERMAL CHARACTERISTICS

Characteristic	Symbol	Max	Unit
Thermal Resistance, Junction to Case	$R_{\theta JC}$	2.5	$^\circ\text{C}/\text{W}$

NOTE — **CAUTION** — MOS devices are susceptible to damage from electrostatic charge. Reasonable precautions in handling and packaging MOS devices should be observed.

ELECTRICAL CHARACTERISTICS ($T_C = 25^\circ\text{C}$ unless otherwise noted)

Characteristic	Symbol	Min	Typ	Max	Unit
OFF CHARACTERISTICS					
Drain–Source Breakdown Voltage ($V_{GS} = 0\text{ V}$, $I_D = 5.0\text{ mA}$)	$V_{(BR)DSS}$	65	—	—	V
Zero Gate Voltage Drain Current ($V_{DS} = 28\text{ V}$, $V_{GS} = 0\text{ V}$)	I_{DSS}	—	—	0.5	mA
Gate–Source Leakage Current ($V_{GS} = 20\text{ V}$, $V_{DS} = 0\text{ V}$)	I_{GSS}	—	—	1.0	μA
ON CHARACTERISTICS					
Gate Threshold Voltage ($V_{DS} = 10\text{ V}$, $I_D = 25\text{ mA}$)	$V_{GS(th)}$	1.5	3.0	4.5	V
Forward Transconductance ($V_{DS} = 10\text{ V}$, $I_D = 1.5\text{ A}$)	g_{fs}	0.8	1.1	—	mhos
DYNAMIC CHARACTERISTICS					
Input Capacitance ($V_{DS} = 28\text{ V}$, $V_{GS} = 0\text{ V}$, $f = 1.0\text{ MHz}$)	C_{iss}	—	28	—	pF
Output Capacitance ($V_{DS} = 28\text{ V}$, $V_{GS} = 0\text{ V}$, $f = 1.0\text{ MHz}$)	C_{oss}	—	30	—	pF
Reverse Transfer Capacitance ($V_{DS} = 28\text{ V}$, $V_{GS} = 0\text{ V}$, $f = 1.0\text{ MHz}$)	C_{rss}	—	4.0	—	pF
FUNCTIONAL CHARACTERISTICS					
Common Source Power Gain ($V_{DD} = 28\text{ V}$, $P_{out} = 20\text{ W}$, $f = 500\text{ MHz}$, $I_{DQ} = 25\text{ mA}$)	G_{ps}	13.5	16	—	dB
Drain Efficiency ($V_{DD} = 28\text{ V}$, $P_{out} = 20\text{ W}$, $f = 500\text{ MHz}$, $I_{DQ} = 25\text{ mA}$)	η	50	55	—	%
Electrical Ruggedness ($V_{DD} = 28\text{ V}$, $P_{out} = 20\text{ W}$, $f = 500\text{ MHz}$, $I_{DQ} = 25\text{ mA}$, Load VSWR 30:1 at All Phase Angles)	ψ	No Degradation in Output Power			

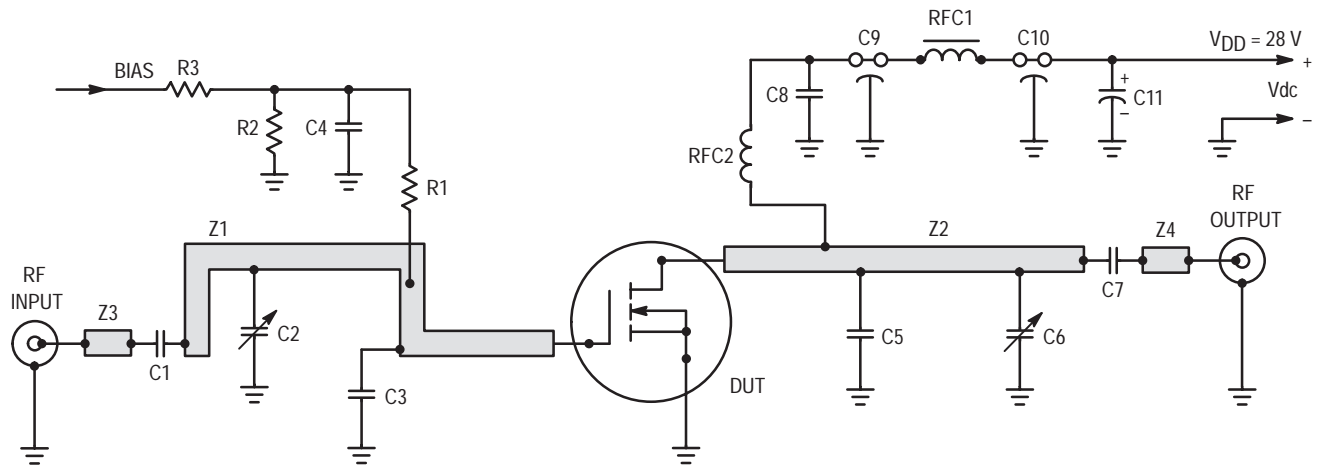

- C1, C7 200 pF, Chip Capacitor
- C2, C6 2–10 pF, Trimmer Capacitor, Johansen
- C3 27 pF, ATC 100 mil Chip Capacitor
- C4, C8 0.1 μ F, Chip Capacitor
- C5 15 pF, ATC 100 mil Chip Capacitor
- C9, C10 680 pF, Feedthru Capacitor
- C11 50 μ F, 50 V, Electrolytic Capacitor
- R1 120 Ω , 1/2 W Resistor
- R2 10 k Ω , 1/2 W Resistor
- R3 1 k Ω , 1/2 W Resistor
- RFC1 Ferroxcube VK200 19/4B
- RFC2 10 Turns AWG #18, 0.125" I.D., Enameled
- Board Material 0.062" Teflon[®] Fiberglass
- 1 oz. Copper Clad Both Sides
- $\epsilon_r = 2.56$

Z1 0.120" x 3.3", Microstrip Line

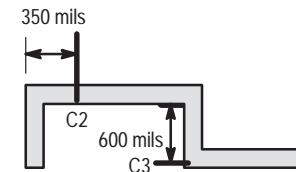

Z2 0.120" x 2.1", Microstrip Line

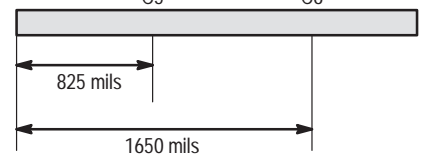

Z3, Z4 0.120" x 0.25", Microstrip Line

Figure 1. MRF166C 500 MHz Test Circuit

TYPICAL CHARACTERISTICS

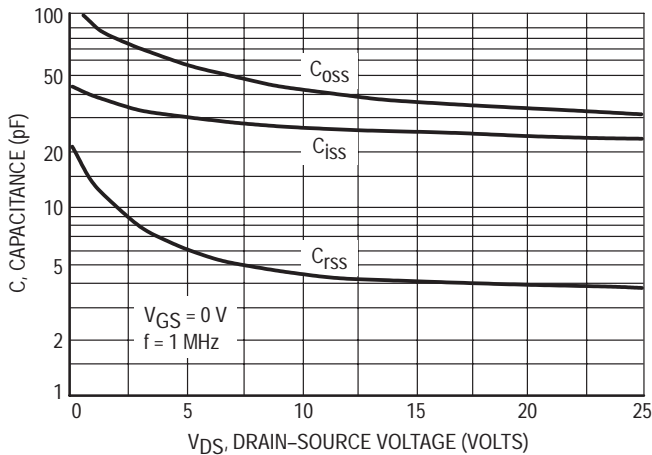

Figure 2. Capacitance versus Drain-Source Voltage

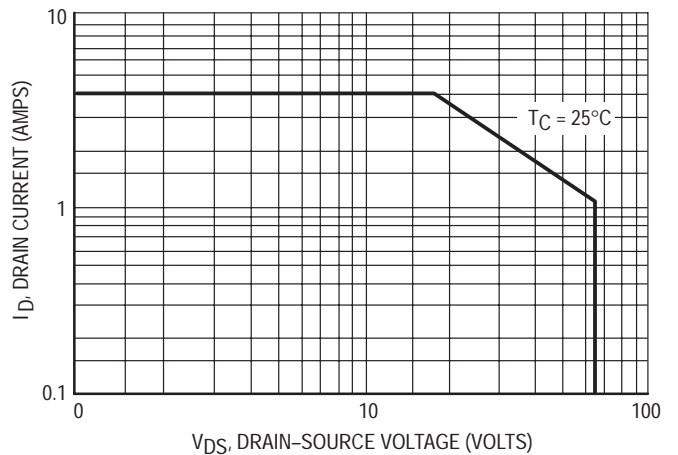

Figure 3. DC Safe Operating Area

TYPICAL CHARACTERISTICS

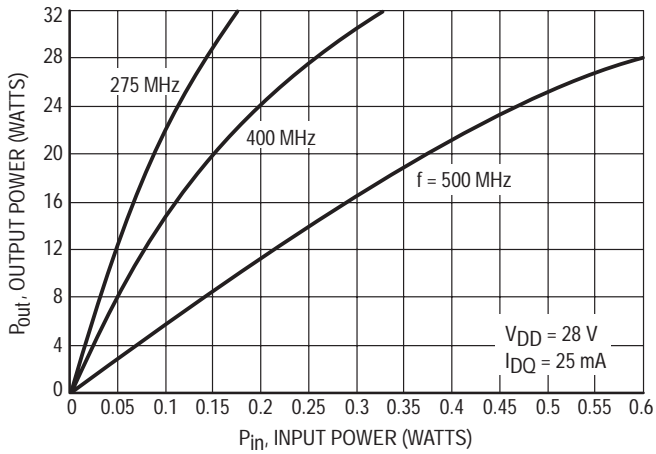

Figure 4. Output Power versus Input Power

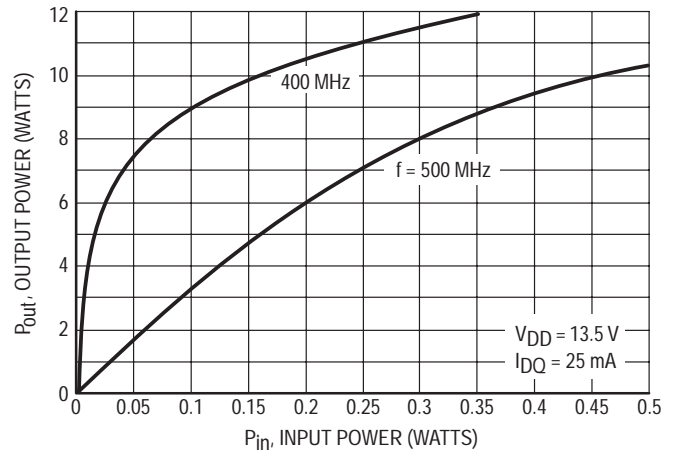

Figure 5. Output Power versus Input Power

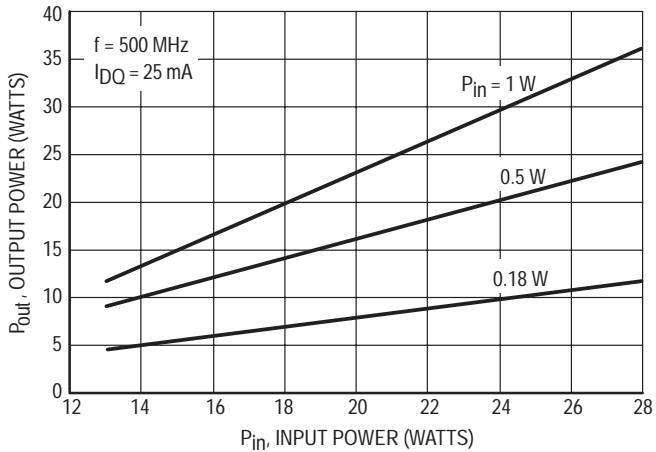

Figure 6. Output Power versus Supply Voltage

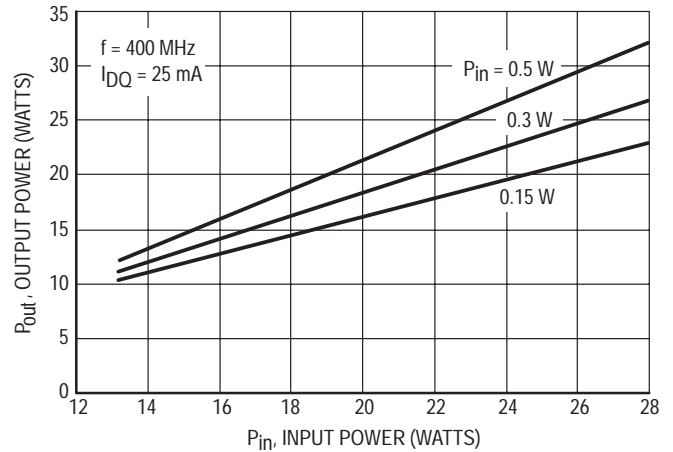
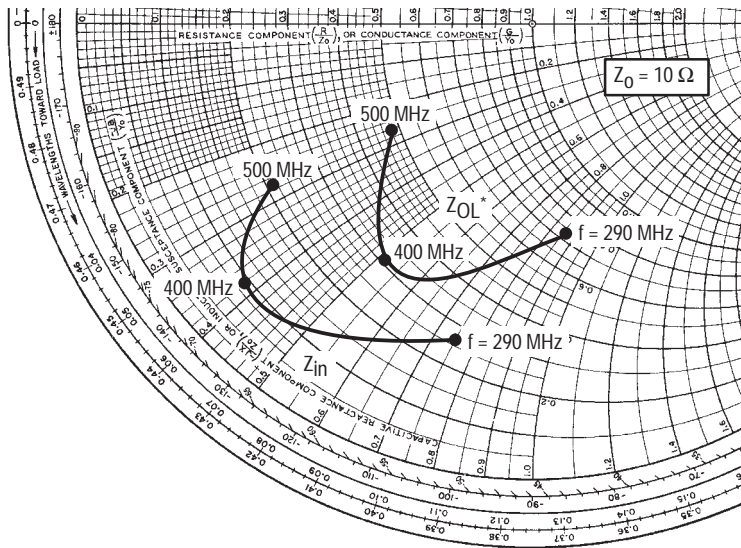

Figure 7. Output Power versus Supply Voltage

$V_{DD} = 28\text{ V}$, $I_{DQ} = 25\text{ mA}$, $P_{out} = 20\text{ Watts}$



f MHz	Z_{in} Ohms	Z_{OL}^* Ohms
500	$2.09 - j2.77$	$4.87 - j2.63$
400	$0.93 - j3.80$	$3.09 - j5.24$
290	$2.63 - j7.58$	$7.35 - j8.67$

Z_{OL}^* = Conjugate of the optimum load impedance into which the device output operates at a given output power, voltage and frequency.

Figure 8. Series Equivalent Input and Output Impedance

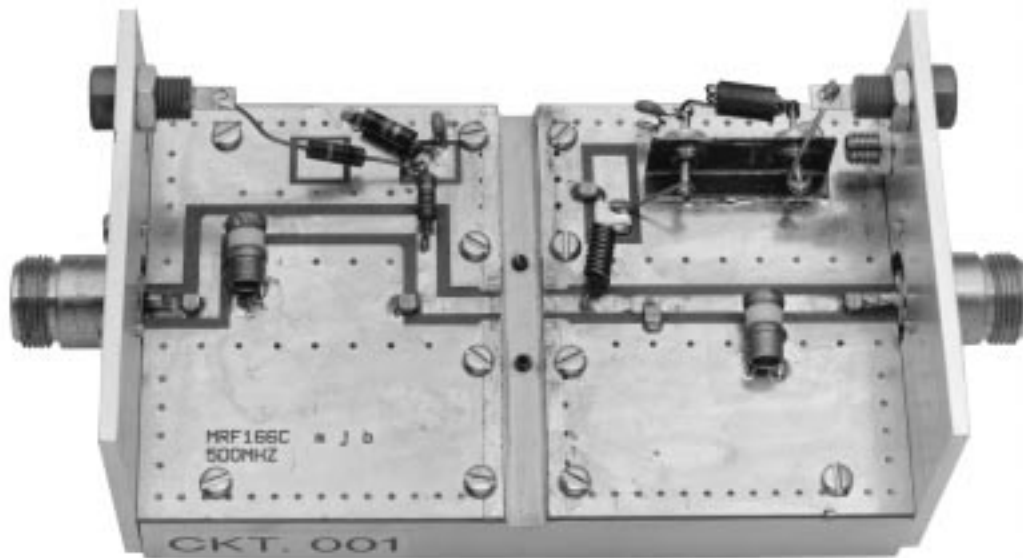

Figure 9. MRF166C Test Fixture

Table 1. Common Source S-Parameters ($V_{DS} = 12.5\text{ V}$, $I_D = 1.25\text{ A}$)

f MHz	S ₁₁		S ₂₁		S ₁₂		S ₂₂	
	S ₁₁	φ	S ₂₁	φ	S ₁₂	φ	S ₂₂	φ
30	0.840	-142	22.59	105	0.025	20	0.727	-155
40	0.836	-151	17.4	100	0.025	17	0.743	-161
50	0.832	-156	14.1	97	0.026	15	0.751	-164
60	0.829	-159	12.0	94	0.026	14	0.764	-166
70	0.826	-162	10.4	91	0.026	14	0.763	-168
80	0.822	-164	9.09	90	0.026	14	0.763	-169
90	0.818	-165	8.07	89	0.027	14	0.765	-170
100	0.819	-167	7.28	87	0.027	14	0.774	-171
110	0.821	-168	6.61	85	0.027	14	0.773	-172
120	0.821	-169	6.00	83	0.026	15	0.771	-172
130	0.820	-169	5.56	83	0.027	16	0.778	-172
140	0.818	-170	5.22	82	0.027	17	0.785	-172
150	0.820	-170	4.86	80	0.027	17	0.786	-173
160	0.821	-171	4.52	79	0.027	17	0.781	-173
170	0.820	-171	4.23	79	0.027	20	0.774	-172
180	0.820	-171	4.03	78	0.027	20	0.799	-173
190	0.820	-172	3.86	76	0.027	20	0.799	-174
200	0.821	-172	3.62	75	0.027	20	0.784	-175
210	0.822	-173	3.39	75	0.027	22	0.780	-174
220	0.823	-173	3.25	74	0.027	24	0.795	-173
230	0.825	-173	3.12	72	0.028	23	0.823	-175
240	0.827	-173	2.96	71	0.026	24	0.791	-175
250	0.827	-174	2.83	70	0.027	26	0.789	-174
260	0.827	-174	2.71	70	0.026	27	0.791	-174
270	0.829	-174	2.62	69	0.027	28	0.801	-174
280	0.831	-174	2.52	68	0.027	29	0.807	-175
290	0.832	-174	2.42	66	0.027	30	0.788	-175
300	0.832	-174	2.32	66	0.027	32	0.792	-175
310	0.831	-174	2.25	66	0.027	33	0.797	-174
320	0.833	-175	2.18	65	0.027	34	0.810	-174
330	0.836	-175	2.10	63	0.028	35	0.812	-175
340	0.837	-175	2.00	62	0.027	35	0.789	-176
350	0.838	-175	1.95	62	0.028	39	0.806	-173
360	0.839	-175	1.90	61	0.028	39	0.817	-174
370	0.840	-176	1.84	60	0.028	40	0.817	-175
380	0.843	-176	1.77	59	0.028	41	0.811	-175
390	0.845	-176	1.71	59	0.028	42	0.805	-175
400	0.846	-176	1.66	58	0.029	46	0.801	-172
410	0.846	-176	1.64	57	0.030	46	0.845	-174
420	0.847	-176	1.59	56	0.030	46	0.836	-176
430	0.848	-176	1.52	56	0.030	47	0.823	-176
440	0.850	-176	1.48	56	0.030	49	0.816	-174

Table 1. Common Source S-Parameters ($V_{DS} = 12.5\text{ V}$, $I_D = 1.25\text{ A}$) (continued)

f MHz	S ₁₁		S ₂₁		S ₁₂		S ₂₂	
	S ₁₁	φ	S ₂₁	φ	S ₁₂	φ	S ₂₂	φ
450	0.851	-176	1.47	54	0.032	51	0.851	-174
460	0.853	-177	1.42	53	0.032	48	0.849	-178
470	0.853	-177	1.37	53	0.031	51	0.830	-176
480	0.856	-177	1.34	53	0.032	53	0.834	-176
490	0.857	-177	1.32	52	0.033	54	0.841	-175
500	0.859	-177	1.28	51	0.034	54	0.847	-175
600	0.857	178	0.988	41	0.032	73	0.877	180
700	0.884	176	0.789	34	0.047	65	0.881	179
800	0.881	173	0.684	30	0.031	83	0.890	174
900	0.890	172	0.580	26	0.069	71	0.885	176
1000	0.897	170	0.503	24	0.090	60	0.931	173

Table 2. Common Source S-Parameters ($V_{DS} = 28\text{ V}$, $I_D = 1.25\text{ A}$)

f MHz	S ₁₁		S ₂₁		S ₁₂		S ₂₂	
	S ₁₁	φ	S ₂₁	φ	S ₁₂	φ	S ₂₂	φ
30	0.842	-125	29.6	113	0.024	28	0.586	-136
40	0.831	-136	23.2	106	0.025	22	0.607	-145
50	0.822	-143	19.0	101	0.026	19	0.613	-151
60	0.816	-148	16.2	98	0.026	17	0.626	-155
70	0.812	-152	14.1	95	0.027	16	0.635	-157
80	0.806	-155	12.4	92	0.026	15	0.643	-159
90	0.801	-157	11.1	90	0.027	14	0.650	-160
100	0.802	-159	9.97	88	0.027	13	0.656	-161
110	0.805	-161	9.04	86	0.027	13	0.654	-163
120	0.805	-162	8.22	84	0.026	13	0.654	-163
130	0.803	-163	7.59	83	0.026	14	0.663	-163
140	0.801	-164	7.09	82	0.026	14	0.673	-164
150	0.803	-165	6.61	80	0.026	14	0.675	-164
160	0.804	-165	6.16	79	0.026	14	0.674	-164
170	0.803	-166	5.77	78	0.026	16	0.672	-164
180	0.804	-166	5.49	77	0.026	17	0.697	-164
190	0.806	-166	5.25	75	0.026	16	0.700	-165
200	0.806	-167	4.92	73	0.025	16	0.688	-166
210	0.807	-168	4.60	73	0.025	17	0.680	-165
220	0.809	-168	4.40	72	0.025	19	0.689	-165
230	0.812	-168	4.21	70	0.025	19	0.713	-167
240	0.814	-169	3.99	69	0.024	20	0.701	-167
250	0.815	-169	3.83	68	0.024	21	0.707	-166
260	0.816	-169	3.66	67	0.024	22	0.711	-166
270	0.818	-169	3.52	66	0.024	23	0.715	-166
280	0.821	-169	3.39	65	0.025	24	0.718	-167
290	0.822	-170	3.25	63	0.024	26	0.708	-168
300	0.823	-170	3.11	62	0.023	28	0.715	-167

Table 2. Common Source S-Parameters ($V_{DS} = 28\text{ V}$, $I_D = 1.25\text{ A}$) (continued)

f MHz	S ₁₁		S ₂₁		S ₁₂		S ₂₂	
	S ₁₁	φ	S ₂₁	φ	S ₁₂	φ	S ₂₂	φ
310	0.822	-170	2.99	62	0.023	29	0.725	-166
320	0.825	-170	2.89	61	0.024	31	0.734	-166
330	0.828	-171	2.78	60	0.024	33	0.736	-167
340	0.830	-171	2.66	59	0.024	33	0.724	-168
350	0.832	-171	2.59	58	0.024	37	0.739	-166
360	0.834	-171	2.52	57	0.024	39	0.757	-166
370	0.836	-171	2.44	56	0.023	39	0.755	-167
380	0.839	-172	2.34	55	0.023	38	0.745	-167
390	0.840	-172	2.26	54	0.024	40	0.738	-168
400	0.841	-172	2.19	54	0.024	46	0.735	-166
410	0.842	-172	2.14	53	0.025	46	0.787	-167
420	0.844	-172	2.09	51	0.026	46	0.790	-168
430	0.845	-173	1.99	51	0.027	49	0.777	-168
440	0.846	-173	1.93	51	0.026	52	0.770	-167
450	0.849	-173	1.91	49	0.027	53	0.794	-167
460	0.853	-173	1.84	48	0.027	51	0.803	-171
470	0.855	-173	1.77	47	0.027	54	0.787	-170
480	0.857	-174	1.72	47	0.027	57	0.789	-169
490	0.857	-174	1.68	47	0.027	56	0.796	-168
500	0.859	-174	1.64	46	0.029	57	0.802	-169
600	0.862	-179	1.18	33	0.036	77	0.851	-173
700	0.893	178	0.921	26	0.043	75	0.856	-175
800	0.890	175	0.771	22	0.043	78	0.880	-178
900	0.895	173	0.635	17	0.065	74	0.882	-178
1000	0.905	171	0.544	14	0.086	69	0.931	178

NOTES

NOTES

NOTES

PACKAGE DIMENSIONS

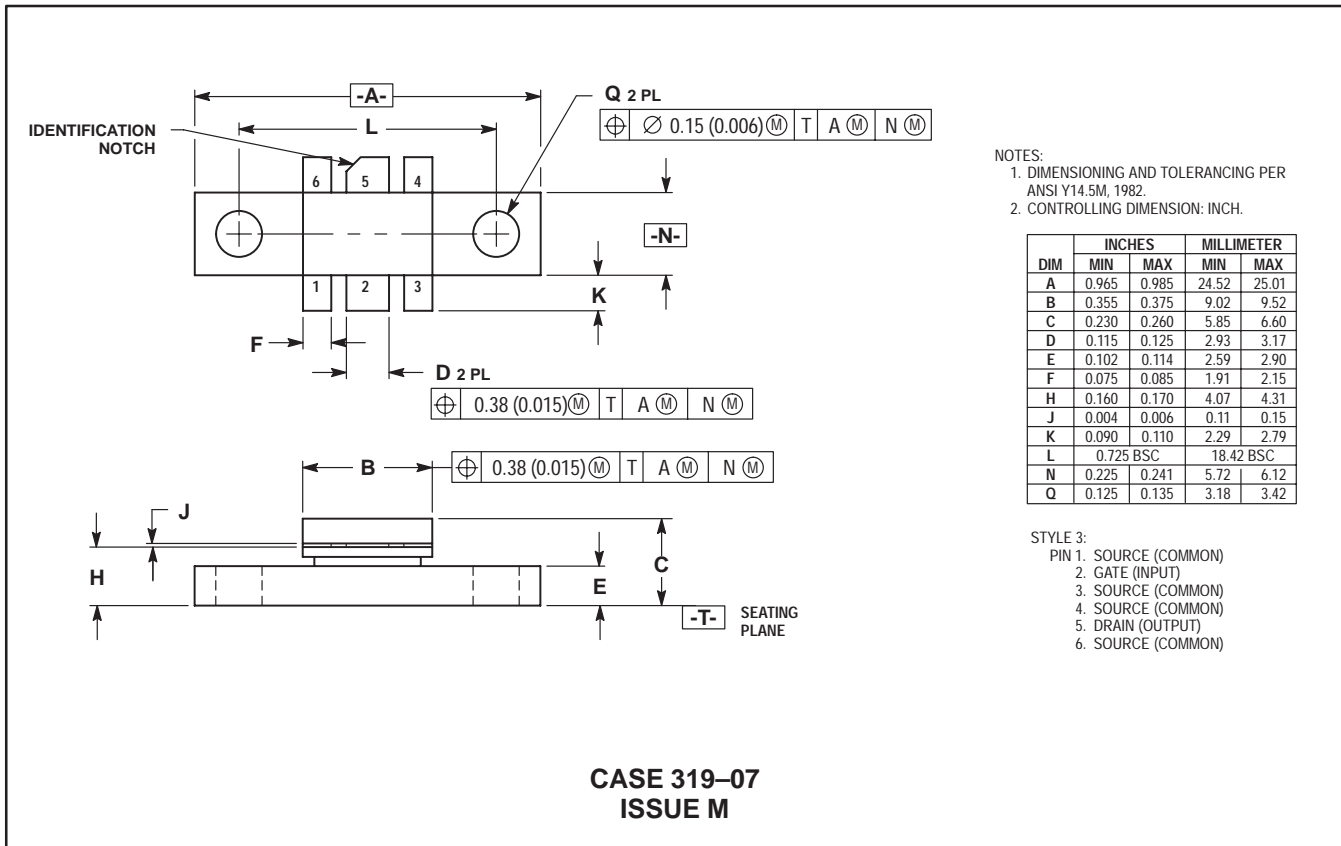

Motorola reserves the right to make changes without further notice to any products herein. Motorola makes no warranty, representation or guarantee regarding the suitability of its products for any particular purpose, nor does Motorola assume any liability arising out of the application or use of any product or circuit, and specifically disclaims any and all liability, including without limitation consequential or incidental damages. "Typical" parameters which may be provided in Motorola data sheets and/or specifications can and do vary in different applications and actual performance may vary over time. All operating parameters, including "Typicals" must be validated for each customer application by customer's technical experts. Motorola does not convey any license under its patent rights nor the rights of others. Motorola products are not designed, intended, or authorized for use as components in systems intended for surgical implant into the body, or other applications intended to support or sustain life, or for any other application in which the failure of the Motorola product could create a situation where personal injury or death may occur. Should Buyer purchase or use Motorola products for any such unintended or unauthorized application, Buyer shall indemnify and hold Motorola and its officers, employees, subsidiaries, affiliates, and distributors harmless against all claims, costs, damages, and expenses, and reasonable attorney fees arising out of, directly or indirectly, any claim of personal injury or death associated with such unintended or unauthorized use, even if such claim alleges that Motorola was negligent regarding the design or manufacture of the part. Motorola and are registered trademarks of Motorola, Inc. Motorola, Inc. is an Equal Opportunity/Affirmative Action Employer.

Mfax is a trademark of Motorola, Inc.

How to reach us:

USA/EUROPE/Locations Not Listed: Motorola Literature Distribution;
P.O. Box 5405, Denver, Colorado 80217. 1-303-675-2140 or 1-800-441-2447

JAPAN: Motorola Japan Ltd.; SPS, Technical Information Center, 3-20-1,
Minami-Azabu, Minato-ku, Tokyo 106-8573 Japan. 81-3-3440-3569

Customer Focus Center: 1-800-521-6274

Mfax™: RMFAX0@email.sps.mot.com – TOUCHTONE 1-602-244-6609
Motorola Fax Back System – US & Canada ONLY 1-800-774-1848
– http://sps.motorola.com/mfax/

ASIA/PACIFIC: Motorola Semiconductors H.K. Ltd.; Silicon Harbour Centre,
2, Dai King Street, Tai Po Industrial Estate, Tai Po, N.T., Hong Kong.
852-26668334

HOME PAGE: <http://motorola.com/sps/>

