

CEFB101-G Thru. CEFB105-G

Reverse Voltage: 50 to 600 Volts

Forward Current: 1.0 Amp

RoHS Device

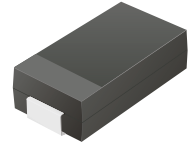

Features

- Ideal for surface mount applications.
- Easy pick and place.
- Plastic package has Underwriters Lab. flammability classification 94V-0.
- Super fast recovery time for high efficient.
- Built-in strain relief.
- Low forward voltage drop.

Mechanical data

- Case: JEDEC DO-214AA, molded plastic.
- Terminals: solderable per MIL-STD-750, method 2026.
- Polarity: Color band denotes cathode end.
- Approx. weight: 0.093 grams

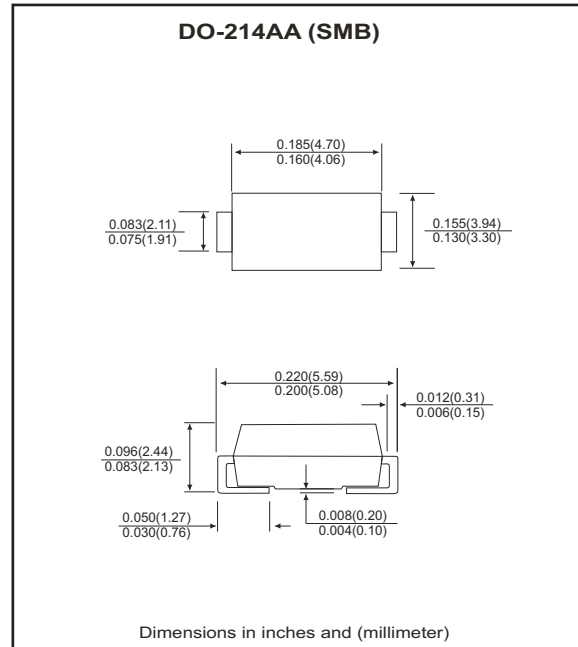

Maximum Ratings and Electrical Characteristics

Parameter	Symbol	CEFB101-G	CEFB102-G	CEFB103-G	CEFB104-G	CEFB105-G	Units
Max. repetitive peak reverse voltage	V_{RRM}	50	100	200	400	600	V
Max. DC blocking voltage	V_{DC}	50	100	200	400	600	V
Max. RMS voltage	V_{RMS}	35	70	140	280	420	V
Peak surge forward current, 8.3ms single half sine-wave superimposed on rate load (JEDEC method)	I_{FSM}	30					A
Max. average forward current	I_o	1.0					A
Max. instantaneous forward voltage at 1.0A	V_F	0.875			1.1	1.25	V
Reverse recovery time	T_{rr}	25			35	50	nS
Max. DC reverse current at $T_A=25\text{ }^{\circ}\text{C}$ rated DC blocking voltage $T_A=125\text{ }^{\circ}\text{C}$	I_R	5.0 200					μA
Max. thermal resistance (Note 1)	$R_{\theta JL}$	13					$^{\circ}\text{C/W}$
Max. operating junction temperature	T_J	150					$^{\circ}\text{C}$
Storage temperature	T_{STG}	-55 to +150					$^{\circ}\text{C}$

Notes: 1. Thermal resistance from junction to lead mounted on P.C.B. with 8.0x8.0 mm copper pad area.

RATING AND CHARACTERISTIC CURVES (CEFB101-G thru CEFB105-G)

Fig.1 Reverse Characteristics

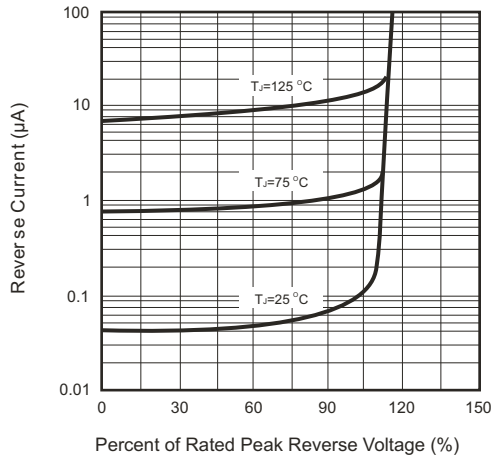

Fig.2 Forward Characteristics

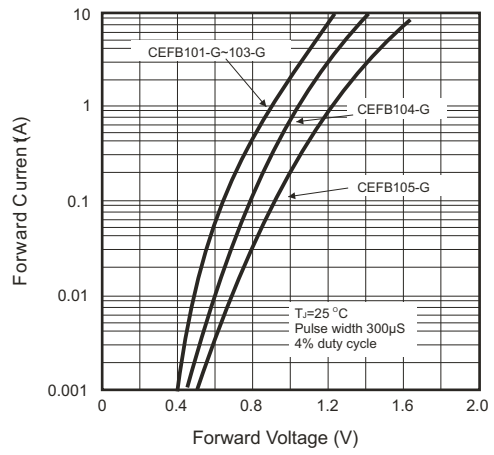

Fig.3 Junction Capacitance

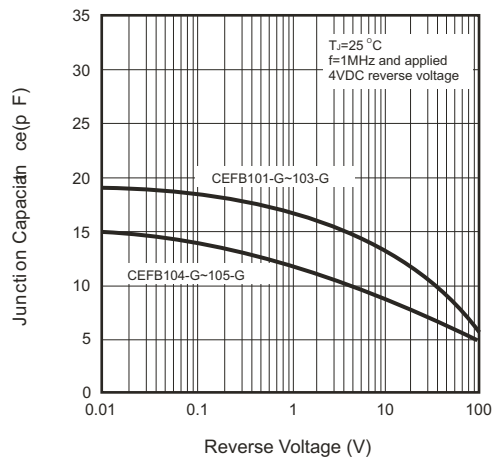

Fig.4 Non-repetitive Forward Surge Current

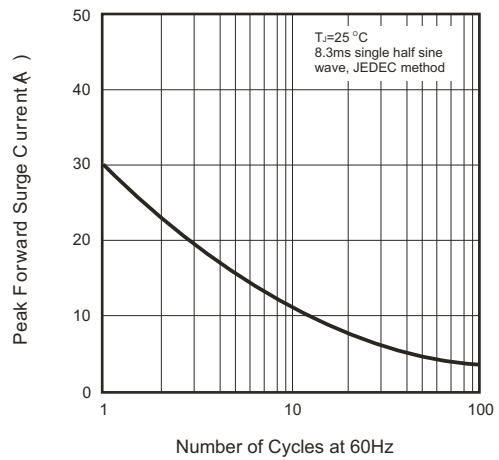

Fig.5 Test Circuit Diagram and Reverse Recovery Time Characteristics

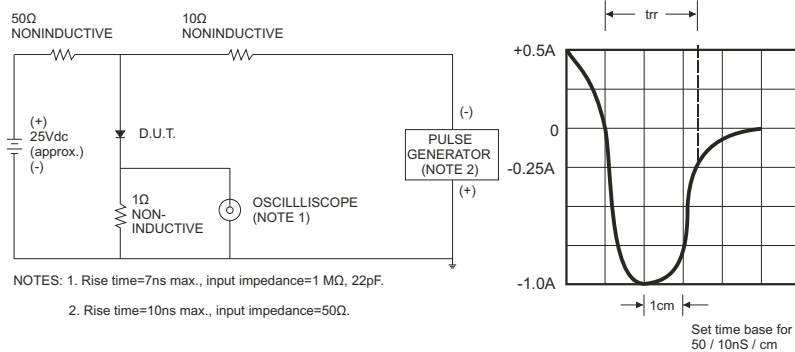

Fig.6 Current Derating Curve

