

RoHS Compliant Product

Description

The SST2605 utilized advance processing techniques to achieve the lowest possible on-resistance, extremely efficient and cost-effectiveness device. The SST2605 is universally used for all commercial-industrial applications.

Features

- * Fast Switching Characteristic
- * Lower Gate Charge
- * Small Footprint & Low Profile Package

SOT-26

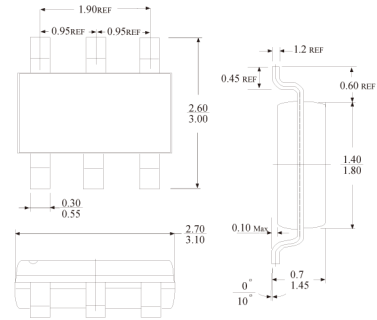

Dimensions in millimeters

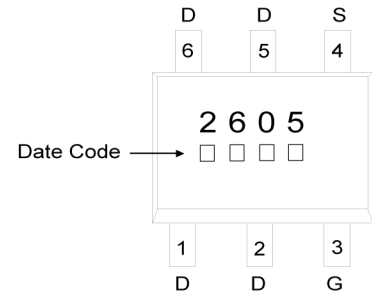
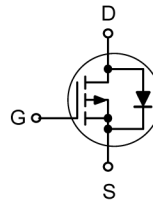

Absolute Maximum Ratings

Parameter	Symbol	Ratings	Unit
Drain-Source Voltage	V _{DS}	-30	V
Gate-Source Voltage	V _{GS}	±20	V
Continuous Drain Current ³	I _D @T _A =25 °C	-4.0	A
Continuous Drain Current ³	I _D @T _A =70 °C	-3.3	A
Pulsed Drain Current ¹	I _{DM}	-20	A
Total Power Dissipation	P _D @T _A =25 °C	2.0	W
Linear Derating Factor		0.016	W/°C
Operating Junction and Storage Temperature Range	T _J , T _{stg}	-55~+150	°C

Thermal Data

Parameter	Symbol	Ratings	Unit
Thermal Resistance Junction-ambient ³	R _{thj-a}	62.5	°C/W

Electrical Characteristics(T_j=25°C Unless otherwise specified)

Parameter	Symbol	Min.	Typ.	Max.	Unit	Test Condition
Drain-Source Breakdown Voltage	BV _{DSS}	-30	-	-	V	V _{GS} =0V, I _D =-250uA
Breakdown Voltage Temp. Coefficient	ΔBV _{DSS} /ΔT _j	-	-0.02	-	V/°C	Reference to 25 °C, I _D =-1mA
Gate Threshold Voltage	V _{GS(th)}	-1.0	-	-3.0	V	V _{DS} =V _{GS} , I _D =-250uA
Gate-Source Leakage Current	I _{GSS}	-	-	±100	nA	V _{GS} =±20V
Drain-Source Leakage Current (T _j =25°C)	I _{DSS}	-	-	-1	uA	V _{DS} =-30V, V _{GS} =0
Drain-Source Leakage Current (T _j =55°C)		-	-	-25	uA	V _{DS} =-24V, V _{GS} =0
Static Drain-Source On-Resistance ²	R _{DS(ON)}	-	-	80	mΩ	V _{GS} =-10V, I _D =-4.0A
		-	-	120		V _{GS} =-4.5V, I _D =-3.0A
Total Gate Charge ²	Q _g	-	5.5	8.8	nC	I _D =-4.0A V _{DS} =-24V V _{GS} =-4.5V
Gate-Source Charge	Q _{gs}	-	1	-		
Gate-Drain ("Miller") Charge	Q _{gd}	-	2.6	-		
Turn-on Delay Time ²	T _{d(ON)}	-	7	-	nS	V _{DD} =-15V I _D =-1A V _{GS} =-10V R _G =3.3Ω R _D =15 Ω
Rise Time	T _r	-	6	-		
Turn-off Delay Time	T _{d(OFF)}	-	18	-		
Fall Time	T _f	-	4	-		
Input Capacitance	C _{iss}	-	400	640	pF	V _{GS} =0V V _{DS} =-25V f=1.0MHz
Output Capacitance	C _{oss}	-	90	-		
Reverse Transfer Capacitance	C _{rss}	-	30	-		
Forward Transconductance	G _{fs}	-	6	-	S	V _{DS} =-5V, I _D =-4.0A

Source-Drain Diode

Parameter	Symbol	Min.	Typ.	Max.	Unit	Test Condition
Forward On Voltage ²	V _{DS}	-	-	-1.2	V	I _S =-1.6A, V _{GS} =0V.
Reverse Recovery Time ²	T _{rr}	-	21	-	nS	I _S =-4.0A, V _{GS} =0V di/dt=100A/us
Reverse Recovery Charge	Q _{rr}	-	14	-	nC	

Notes: 1.Pulse width limited by safe operating area.

2.Pulse width ≤300us, dutycycle ≤2%.

3.Surface mounted on 1 in² copper pad of FR4 board; 156°C/W when mounted on Min. copper pad.

Characteristics Curve

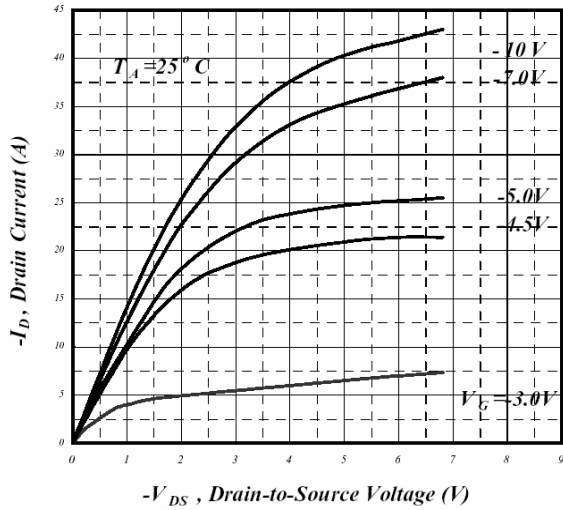

Fig 1. Typical Output Characteristics

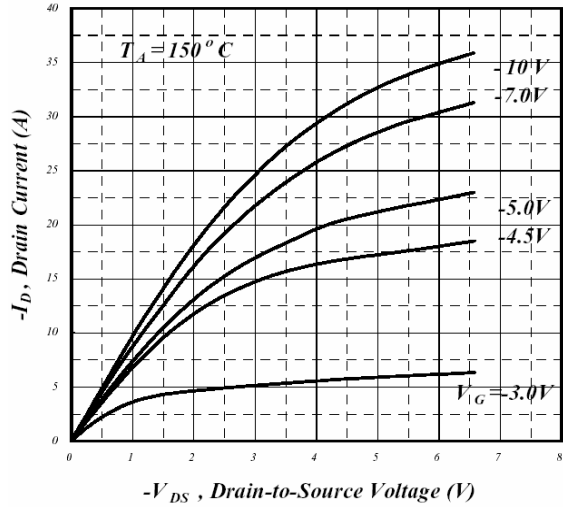

Fig 2. Typical Output Characteristics

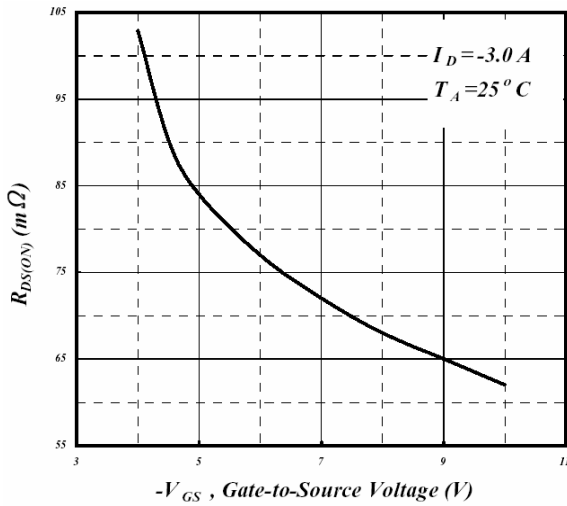

Fig 3. On-Resistance v.s. Gate Voltage

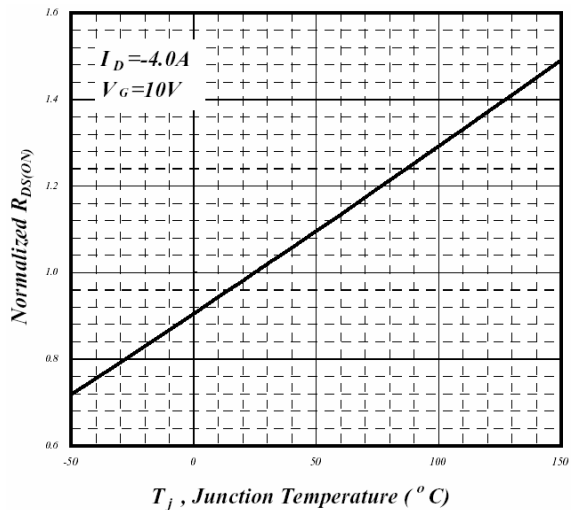

Fig 4. Normalized On-Resistance v.s. Junction Temperature

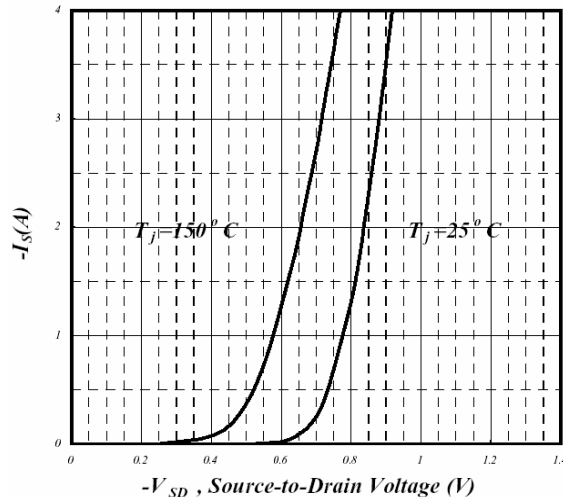

Fig 5. Forward Characteristics of Reverse Diode

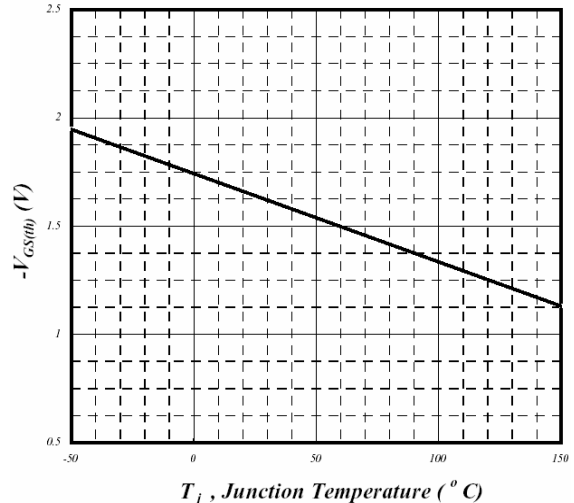

Fig 6. Gate Threshold Voltage v.s. Junction Temperature

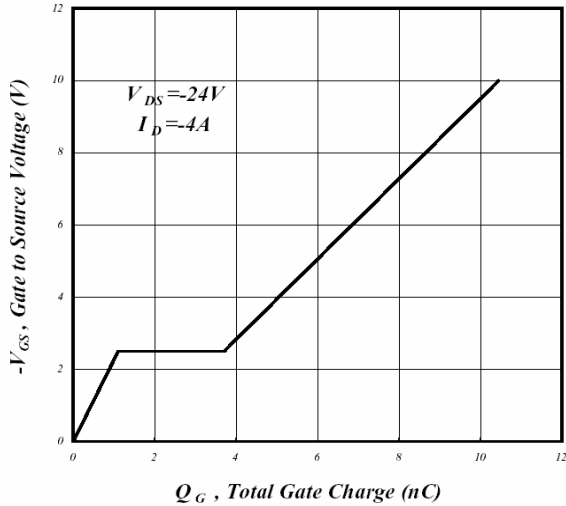

Fig 7. Gate Charge Characteristics

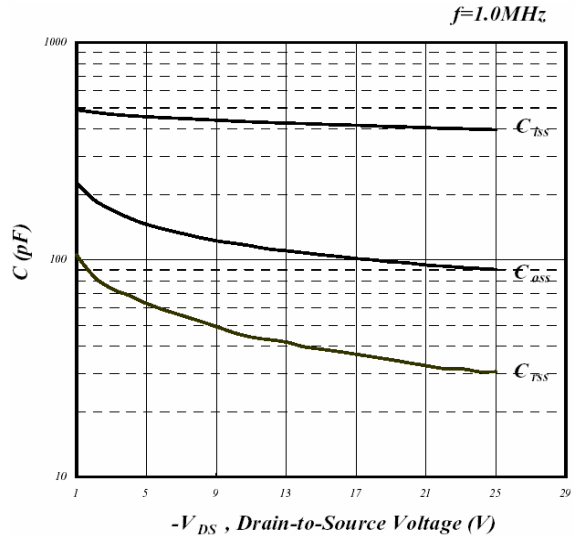

Fig 8. Typical Capacitance Characteristics

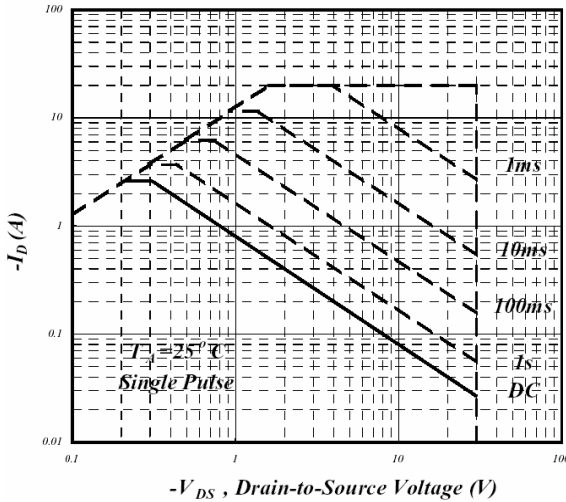

Fig 9. Maximum Safe Operating Area

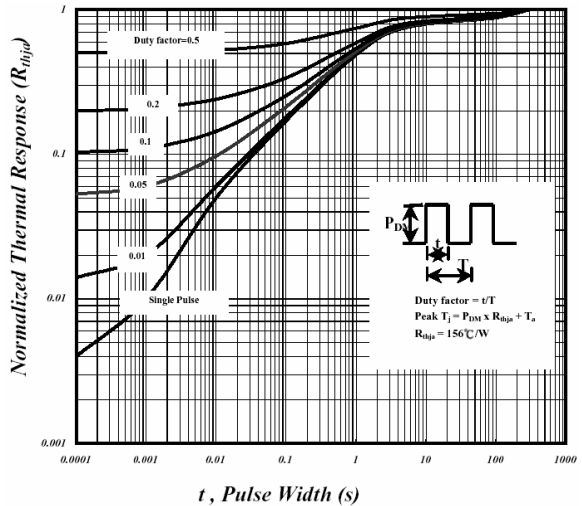

Fig 10. Effective Transient Thermal Impedance

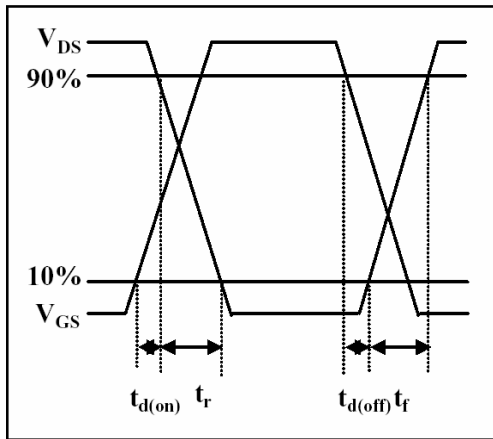

Fig 11. Switching Time Waveform

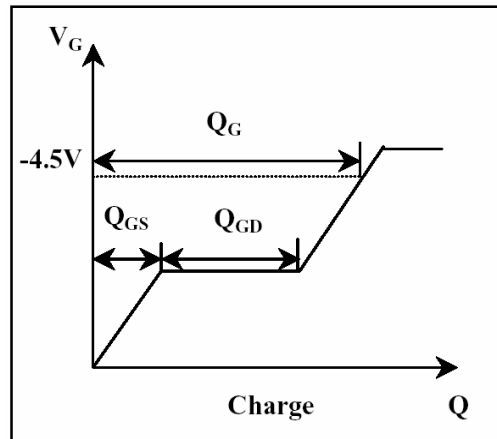

Fig 12. Gate Charge Waveform