

Hex 2-input NAND drivers

74F804/1804

FEATURES

- High capacitive drive capability
- Choice of configuration
 Corner V_{CC} and GND – 74F804
 Center V_{CC} and GND – 74F1804
- Typical propagation delay of 2.5ns

TYPE	TYPICAL PROPAGATION DELAY	TYPICAL SUPPLY CURRENT (TOTAL)
74F804	2.5ns	9mA
74F1804	2.5ns	9mA

ORDERING INFORMATION

DESCRIPTION	ORDER CODE
	COMMERCIAL RANGE $V_{CC} = 5V \pm 10\%$, $T_{amb} = 0^{\circ}C$ to $+70^{\circ}C$
20-pin plastic DIP	N74F804N, N74F1804N
20-pin plastic SOL	N74F804D, N74F1804D

INPUT AND OUTPUT LOADING AND FAN OUT TABLE

PINS	DESCRIPTION	74F (U.L.) HIGH/LOW	LOAD VALUE HIGH/LOW
Dna – Dnb	Data inputs	1.0/0.033	20 μ A/20 μ A
Q0 – Q5	Data outputs	2400/80	48mA/48mA

NOTE: One (1.0) FAST unit load is defined as: 20 μ A in the high state and 0.6mA in the low state.

PIN CONFIGURATION

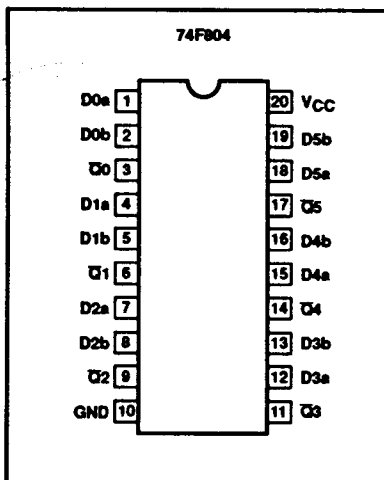

LOGIC SYMBOL

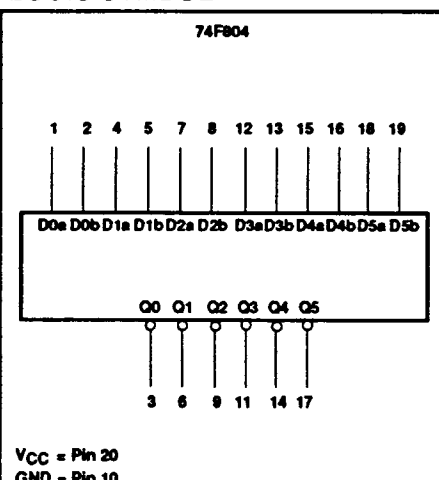

IEC/IEEE SYMBOL

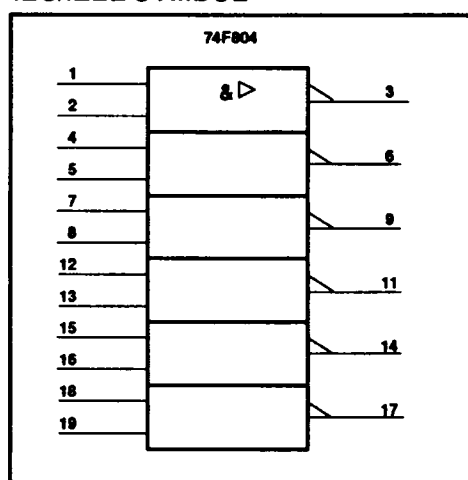

PIN CONFIGURATION

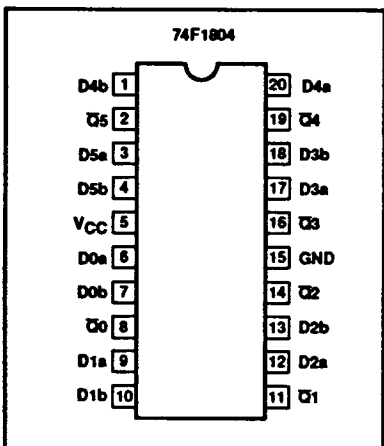

LOGIC SYMBOL

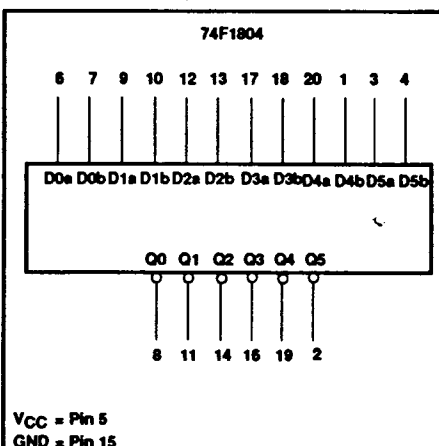

IEC/IEEE SYMBOL

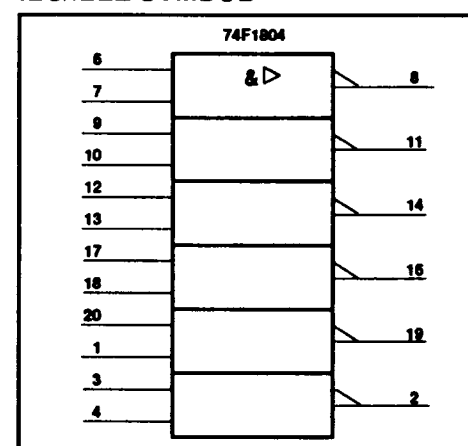

Hex 2-input NAND drivers

74F804/1804

LOGIC DIAGRAM

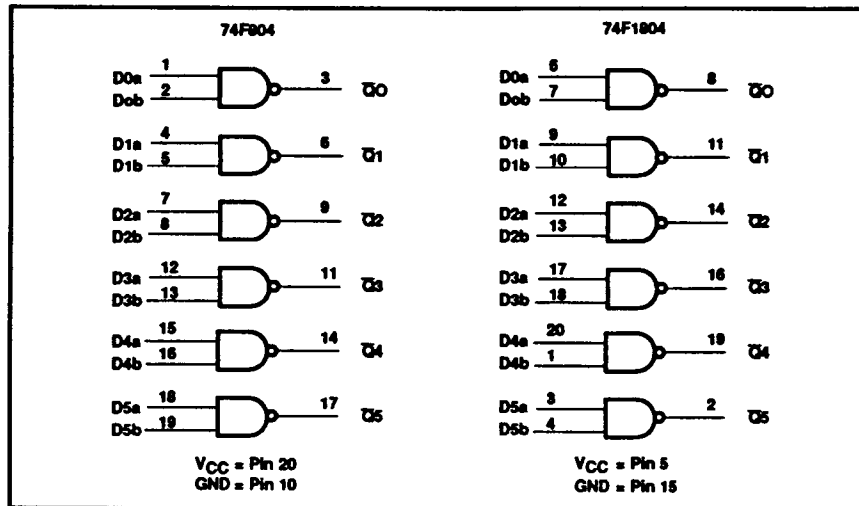

FUNCTION TABLE

INPUTS		OUTPUT
D _a	D _b	\bar{Q}
H	H	L
L	X	H
X	L	H

NOTES:

- 2. H = High voltage level
- 3. L = Low voltage level
- 4. X = Don't care

ABSOLUTE MAXIMUM RATINGS

(Operation beyond the limit set forth in this table may impair the useful life of the device. Unless otherwise noted these limits are over the operating free air temperature range.)

SYMBOL	PARAMETER	RATING	UNIT
V _{CC}	Supply voltage	-0.5 to +7.0	V
V _{IN}	Input voltage	-0.5 to +7.0	V
I _{IN}	Input current	-30 to +5	mA
V _{OUT}	Voltage applied to output in high output state	-0.5 to V _{CC}	V
I _{OUT}	Current applied to output in low output state	96	mA
T _{amb}	Operating free-air temperature range	0 to +70	°C
T _{stg}	Storage temperature range	-65 to +150	°C

RECOMMENDED OPERATING CONDITIONS

SYMBOL	PARAMETER	LIMITS			UNIT
		MIN	NOM	MAX	
V _{CC}	Supply voltage	4.5	5.0	5.5	V
V _{IH}	High-level input voltage	2.0			V
V _{IL}	Low-level input voltage			0.8	V
I _{ik}	Input clamp current			-18	mA
I _{OH}	High-level output current			-48	mA
I _{OL}	Low-level output current			48	mA
T _{amb}	Operating free air temperature range	0		+70	°C

Hex 2-input NAND drivers

74F804/1804

DC ELECTRICAL CHARACTERISTICS

(Over recommended operating free-air temperature range unless otherwise noted.)

SYMBOL	PARAMETER	TEST CONDITIONS ¹		LIMITS			UNIT	
				MIN	TYP ²	MAX		
V _{OH}	High-level output voltage	V _{CC} = MIN, V _L = MAX V _{IH} = MIN, I _{OH} = MAX	±10%V _{CC}	2.0			V	
			±5%V _{CC}	2.0			V	
V _{OL}	Low-level output voltage	V _{CC} = MIN, V _L = MAX V _{IH} = MIN, I _{OL} = MAX	±10%V _{CC}		0.38	0.55	V	
			±5%V _{CC}		0.38	0.55	V	
V _{IK}	Input clamp voltage	V _{CC} = MIN, I _I = I _{IK}			-0.73	-1.2	V	
I _I	Input current at maximum input voltage	V _{CC} = MAX, V _I = 7.0V				100	μA	
I _{IH}	High-level input current	V _{CC} = MAX, V _I = 2.7V				20	μA	
I _{IL}	Low-level input current	V _{CC} = MAX, V _I = 0.5V				-20	μA	
I _O	Output current ³	V _{CC} = MAX		-60		-160	mA	
I _{CC}	Supply current (total)	I _{CC} H	V _{CC} = MAX	V _{IN} = GND		2.0	3.0	mA
		I _{CC} L	V _{CC} = MAX	V _{IN} = 4.5V		15	20	mA

NOTES:

- For conditions shown as MIN or MAX, use the appropriate value specified under recommended operating conditions for the applicable type.
- All typical values are at V_{CC} = 5V, T_{amb} = 25°C.
- The output conditions have been chosen to produce a current that closely approximates one half of the true short-circuit output current, I_{OS}.

AC ELECTRICAL CHARACTERISTICS

SYMBOL	PARAMETER	TEST CONDITION	LIMITS						UNIT
			T _{amb} = +25°C V _{CC} = +5.0V C _L = 50pF, R _L = 500Ω			T _{amb} = 0°C to +70°C V _{CC} = +5.0V ± 10% C _L = 50pF, R _L = 500Ω			
			MIN	TYP	MAX	MIN	MAX		
t _{PLH} t _{PHL}	Propagation delay D _{na} , D _{nb} to \bar{Q} _n	Waveform 1	1.0 1.0	2.0 3.0	4.0 4.5	1.0 1.0	4.0 5.0	ns	
t _{sk(o)}	Output skew ^{1,2}	Waveform 2			1.5		1.5	ns	

NOTES:

- [t_{pN} actual - t_{pM} actual] for any output compared to any other output where N and M are either LH or HL.
- Skew times are valid only under same test conditions (temperature, V_{CC}, loading, etc.).

Hex 2-input NAND drivers

74F804/1804

AC WAVEFORMS

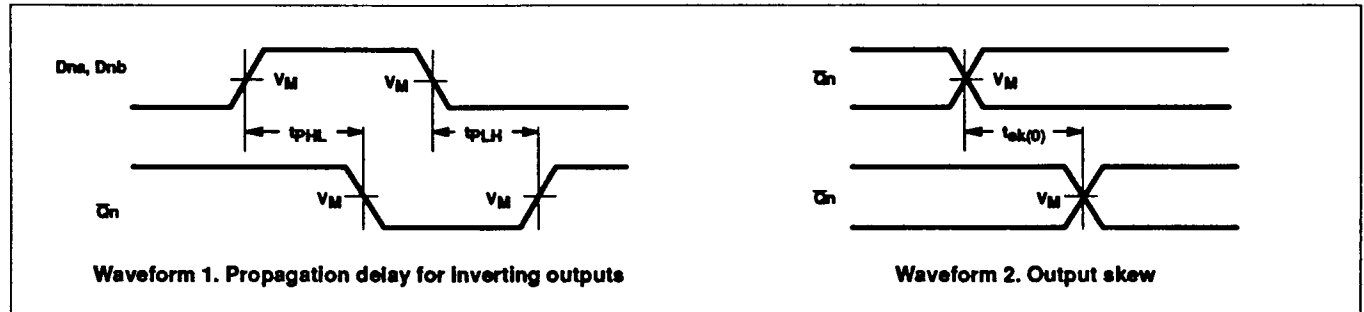

NOTE: For all waveforms, $V_M = 1.5V$.

TEST CIRCUIT AND WAVEFORMS

