

EMI Core

EMI Co



- All specifications in this catalog and production status of products are subject to change without notice. Prior to the purchase, please contact NEC TOKIN for updated product data.
- Please request for a specification sheet for detailed product data prior to the purchase.
- Before using the product in this catalog, please read "Precautions" and other safety precautions listed in the printed version catalog.

Contents

Introduction of EMI Core	4
Tips on EMI Core Usages	5
New Product	
Toroidal Cores for Round Cables with High Heat Resistance and Cable Holding Mechanism ESD-R-H Series	6
Snap-on Cores for Round Cables with High Heat Resistance and Cable Holding Mechanism ESD-SR-H Series	7
Ring Type	
Toroidal Cores (Bare Type)	8
Toroidal Cores (Coated Type)	12
Toroidal Cores with Case	14
Toroidal Cores with Snail-shaped Case	16
Snap-on Type	
Snap-on Cores for Round Cables	18
Flat Type	
Solid / Split Cores for Flat Cables	20
Bead Type	
Bead Cores	28













- All specifications in this catalog and production status of products are subject to change without notice. Prior to the purchase, please contact NEC TOKIN for updated product data.
- Please request for a specification sheet for detailed product data prior to the purchase.
- Before using the product in this catalog, please read "Precautions" and other safety precautions listed in the printed version catalog.

EMI Core Vol.09



- All specifications in this catalog and production status of products are subject to change without notice. Prior to the purchase, please contact NEC TOKIN for updated product data.
- Please request for a specification sheet for detailed product data prior to the purchase.
- Before using the product in this catalog, please read "Precautions" and other safety precautions listed in the printed version catalog.

Introduction of EMI Core

		Series Name	Shape	Model	Material	Outer Diameter (mm)	Inner Diameter (mm)	Height (mm)	Page
Solid	for Round Cables								
	Bare type	Toroidal Cores (Bare Type)		ESD-R	Mn-Zn & Ni-Zn	9.5~38.1	5.0~19.0	3.0~28.5	8
	Coated type	Toroidal Cores (Coated Type)		ESD-R	Mn-Zn & Ni-Zn	12.0~32.0	6.2~19.0	3.0~28.8	12
	with Case	Toroidal Cores with Case		ESD-R	Mn-Zn & Ni-Zn	12.9~61.0	6.0~32.4	6.4~24.0	14
	with Snail-shaped Case	Toroidal Cores with Snail-shaped Case		ESD-R-B	Mn-Zn & Ni-Zn	21.5~51.5	8.8~25.5	13.0~17.5	16
	with High Heat Resistance and Cable Holding Mechanism	Toroidal Cores (ESD-R-H series)		ESD-R-H	Mn-Zn	52.5	22.7	8.5	6
	for Flat Cables								
	Bare type	Solid Core for Flat Cables		ESD-FPL	Ni-Zn	14.5~80.0	0.55~2.2	2.75~12.0	20
Split	for Round Cables								
	with Case	Snap-on Core for Round Cables (ESD-SR series)		ESD-SR	Ni-Zn	—	φ6~φ14.5	—	18
	with High Heat Resistance and Cable Holding Mechanism	Snap-on Core for Round Cables (ESD-SR-H series)		ESD-SR-H	Ni-Zn	—	φ9~φ13	—	7
	for Flat Cables								
	with Metal Clamp	Split Core for Flat Cables		ESD-FPD	Ni-Zn	37.0~80.0	2.0~2.6	10	21
	with Plastic	Split Core for Flat Cables		ESD-FPD-1	Ni-Zn	37.0~80.0	2.0~2.6	10	21
Beads	Single Piece Core	Beads Core		B-20	Mn-Zn & Ni-Zn	2.8~9.7	0.8~4.8	1.2~8.0	28

Case by case product guide

- **When you have worry about damages to cable covering and insulation.**
Coated Type Core, Core with Case page 12~15
- **When you want to retrofit the core**
Hinged-Clamp Core
· For Round Cable: ESD-SR, ESD-SR-H series page 18~19
· For Flat Cable: ESD-FPD series page 21
- **When you want to fix the core**
Core with Snail Shaped Case
· For Round Cable: ESD-R-B, ESD-R-H series page 16~17
· For Flat Cable: ESD-FPD-1 series page 21



● All specifications in this catalog and production status of products are subject to change without notice. Prior to the purchase, please contact NEC TOKIN for updated product data.
● Please request for a specification sheet for detailed product data prior to the purchase.
● Before using the product in this catalog, please read "Precautions" and other safety precautions listed in the printed version catalog.

Tips on EMI Core Usages

■ Characteristics and how to count turns

Number of turns are counted by how many times the lead wire passes through the inner hole of the core. Do not count the number of lead wire winding outside the core, as it results in different turn count. (Fig. 1)

When desired performance can not be obtained just by 1 turn, impedance characteristics value can be raised by increasing the turn. In this case, the effective frequency band should be checked that it is in the desired range as adding turns results in lowering down the effective band range. (Fig. 2)

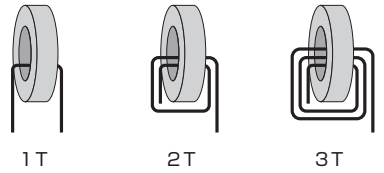

*Number of lead wire wound outside the core + 1
 = Number of read wire passes through the inner hole of the core
 = Turn count

Fig.1 How to count turns

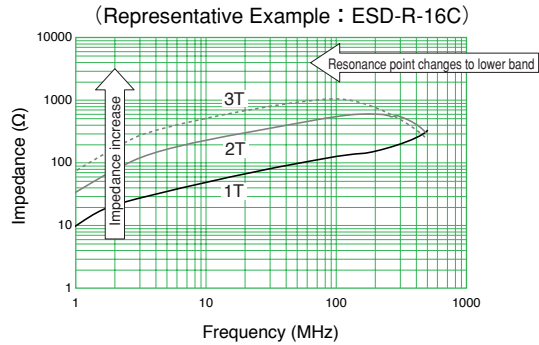

Fig.2 Relationship between impedance and turn counts

■ Effective band range depending on core material

There are two materials of ferrite, Ni-Zn series and Mn-Zn series. Ni-Zn series is effective for MHz band range such as FM band while Mn-Zn series is effective for kHz band range.

Note that above effective band range is a reference only. Examination of effectiveness with actual instrument is necessary.

As Mn-Zn series has lower resistance compared to Ni-Zn series, make sure to provide adequate insulation before use.

Mn-Zn series vs Ni-Zn series |Z|-f Characteristics (representative example)
 (measurement condition: measured with same-dimension ring core)

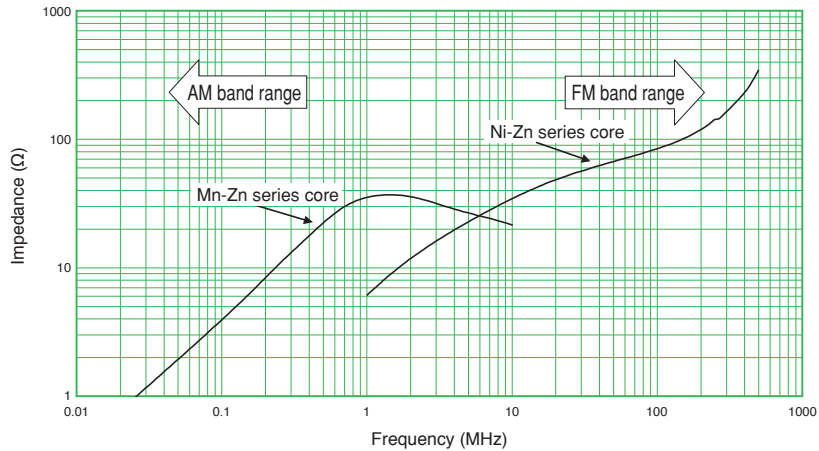

Fig.3 Effective Band Range of Mn-Zn series / Ni-Zn series ferrite



- All specifications in this catalog and production status of products are subject to change without notice. Prior to the purchase, please contact NEC TOKIN for updated product data.
- Please request for a specification sheet for detailed product data prior to the purchase.
- Before using the product in this catalog, please read "Precautions" and other safety precautions listed in the printed version catalog.

Toroidal Cores for Round Cables with High Heat Resistance and Cable Holding Mechanism

ESD-R-H Series

[RoHS Compliant]

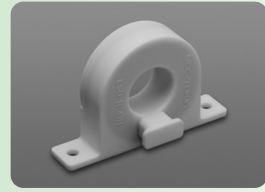

Features

- ① Improved maximum allowable temperature
(Increased from up to 60°C to up to 120°C)
- ② Holding mechanisms provided
(Enables installation with two M4 screws / holding of cables with bands)
- ③ Our unique core material enables high performance in low frequency range

Applications

- Consumer electronics
(air conditioners, refrigerators, etc.)
- Industrial equipment (INV, robots, etc.)

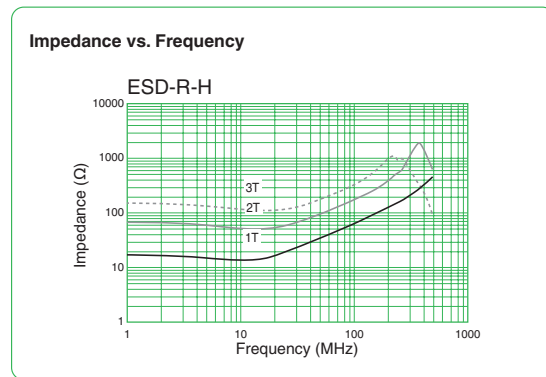
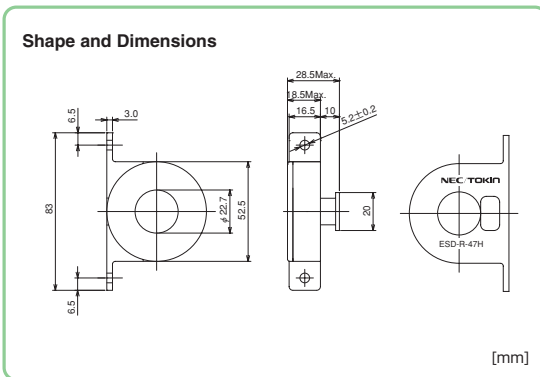

Model	Dimensions (mm)				Frequency range		Color of case	Compatible toroidal core
	A	B	C	D	up to 100MHz (mainly AM band range)	up to 300MHz (mainly FM band range)		
ESD-R-47H	52.5	22.7	8.5	83	●		white	—



- All specifications in this catalog and production status of products are subject to change without notice. Prior to the purchase, please contact NEC TOKIN for updated product data.
- Please request for a specification sheet for detailed product data prior to the purchase.
- Before using the product in this catalog, please read "Precautions" and other safety precautions listed in the printed version catalog.

Snap-on Cores for Round Cables with High Heat Resistance and Cable Holding Mechanism

ESD-SR-H Series

[RoHS Compliant]

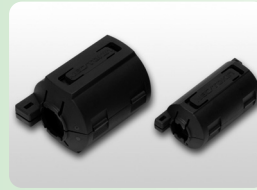

Features

- ①Wider operational temperature range.
Applicable to automotive environment (-40°C~+125°C)
- ②Holding mechanisms provided
(Fixing of cables / enclosures with fixing bands possible)
- ③Our unique core material enables high performance in high frequency range

Applications

- Automotive (ESP, etc.)
- Information and communication devices, audio-visual equipment, consumer electronics

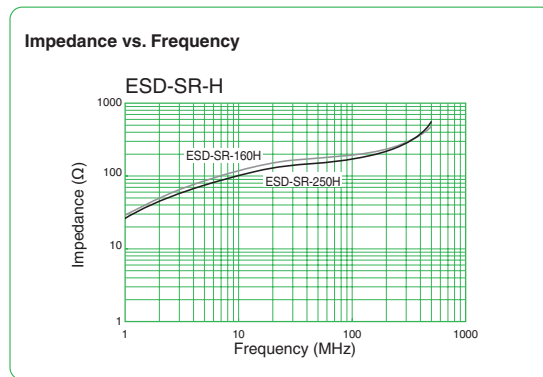
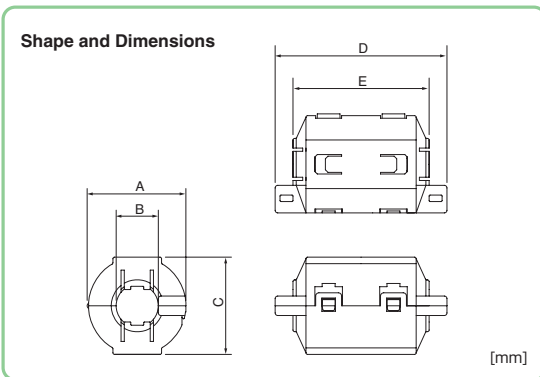

Model	Dimensions (mm)					Weight(g)	Color of case
	A	φ B	C	D	E		
ESD-SR-160H	19.5	~9	19.5	46.5	38.5	23	black
ESD-SR-250H	30	~13	30	53	42	63	black



- All specifications in this catalog and production status of products are subject to change without notice. Prior to the purchase, please contact NEC TOKIN for updated product data.
- Please request for a specification sheet for detailed product data prior to the purchase.
- Before using the product in this catalog, please read "Precautions" and other safety precautions listed in the printed version catalog.

Toroidal Cores (Bare Type)

[RoHS Compliant]



Model	Dimensions (mm)			Frequency range	
	OD	ID	T	up to 100MHz(mainly AM band range)	up to 300MHz(mainly FM band range)
ESD-R-10D	9.5	5.0	10.0		●
ESD-R-10E	10.0	5.0	5.0		●
ESD-R-10S	10.5	5.5	20.0		●
ESD-R-12C	11.8	7.3	15.0		●
ESD-R-12E	11.8	7.3	8.0		●
ESD-R-12F	12.0	8.5	15.0		●
ESD-R-12S	12.0	7.0	5.5		●
ESD-R-14C	14.0	7.0	3.0		●
ESD-R-14E	14.0	10.0	8.0		●
ESD-R-14S	14.3	6.3	28.5		●
ESD-R-15C-1	15.0	10.5	12.0		●
ESD-R-16	15.8	11.6	8.4	●	
ESD-R-16C	16.0	9.0	17.0		●
ESD-R-17S	17.5	9.5	28.5		●
ESD-R-18SD	18.0	10.0	6.0		●
ESD-R-19S	18.5	10.0	10.0	●	
ESD-R-19SD	18.5	10.0	10.0		●
ESD-R-22SD	22.5	13.8	6.4		●
ESD-R-25SD	25.0	15.0	12.0		●
ESD-R-25S	25.0	15.0	12.0	●	
ESD-R-26S	26.0	13.0	28.5		●
ESD-R-28C	28.0	16.0	13.0		●
ESD-R-31C	31.0	19.0	8.0		●
ESD-R-38D	38.1	19.0	12.7	●	

※Other sizes available. Please contact NEC TOKIN.

※Above frequency range is a reference only. Please test with actual device before use.

Shape and Dimensions

●ESD-R Series

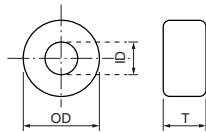

Installation Example

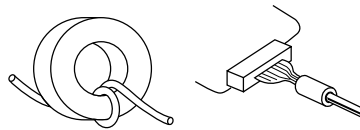

- All specifications in this catalog and production status of products are subject to change without notice. Prior to the purchase, please contact NEC TOKIN for updated product data.
- Please request for a specification sheet for detailed product data prior to the purchase.
- Before using the product in this catalog, please read "Precautions" and other safety precautions listed in the printed version catalog.

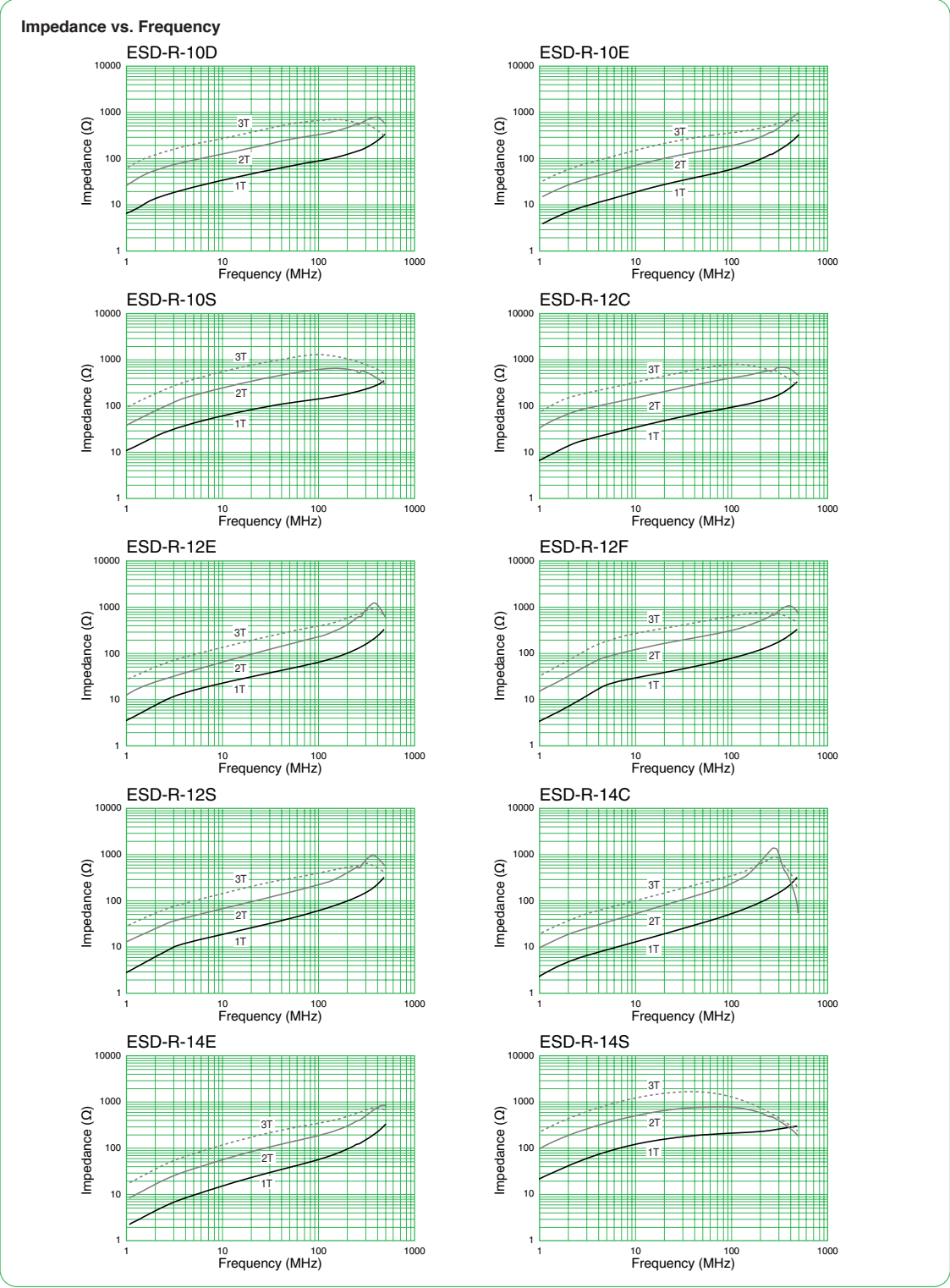

- All specifications in this catalog and production status of products are subject to change without notice. Prior to the purchase, please contact NEC TOKIN for updated product data.
- Please request for a specification sheet for detailed product data prior to the purchase.
- Before using the product in this catalog, please read "Precautions" and other safety precautions listed in the printed version catalog.

Impedance vs. Frequency

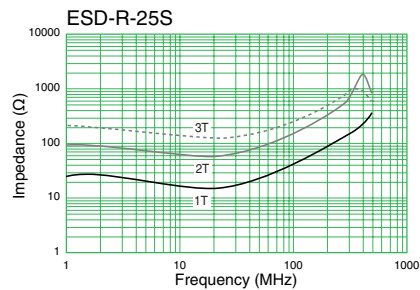
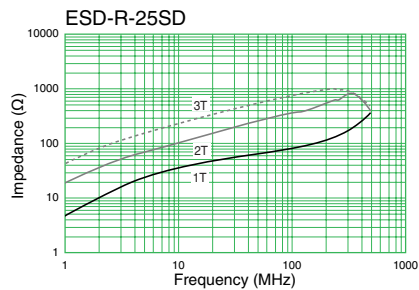
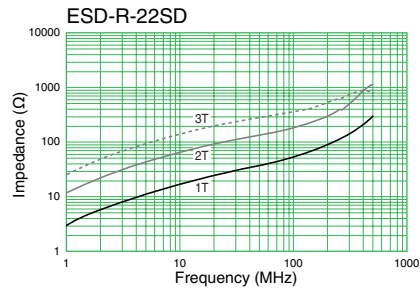
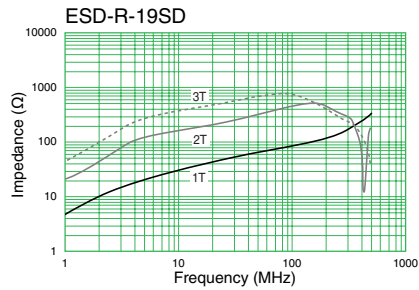
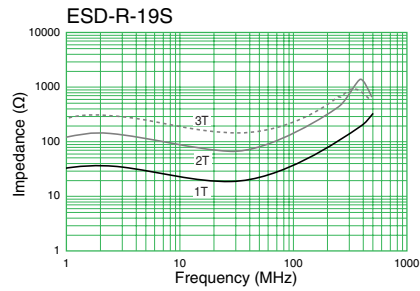
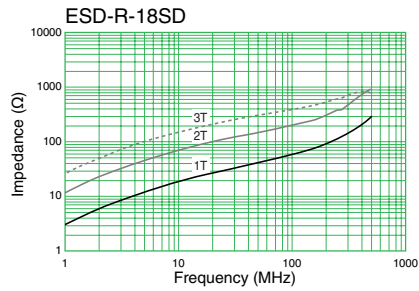
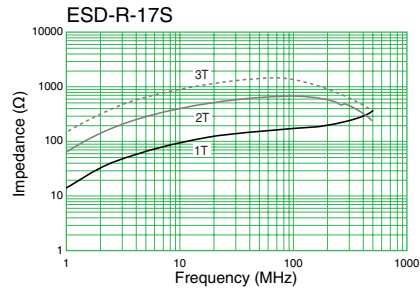
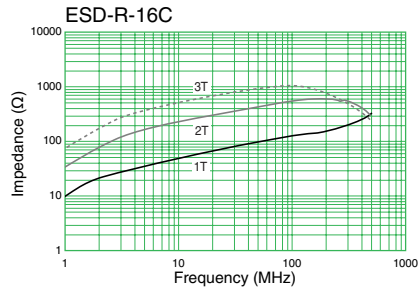
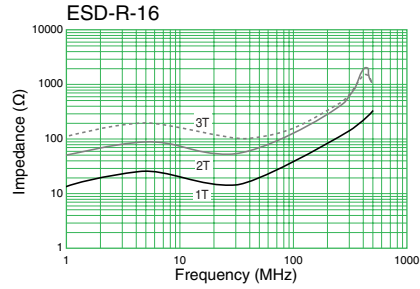
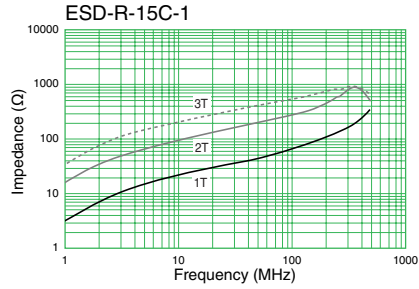

EMI Core



- All specifications in this catalog and production status of products are subject to change without notice. Prior to the purchase, please contact NEC TOKIN for updated product data.
- Please request for a specification sheet for detailed product data prior to the purchase.
- Before using the product in this catalog, please read "Precautions" and other safety precautions listed in the printed version catalog.

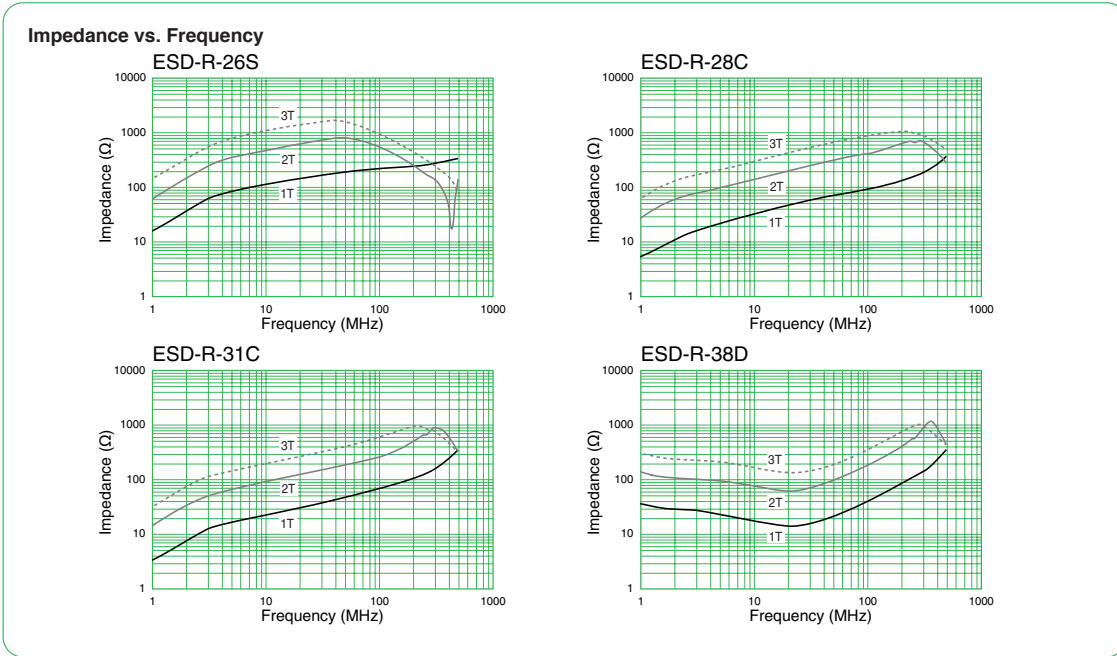

- All specifications in this catalog and production status of products are subject to change without notice. Prior to the purchase, please contact NEC TOKIN for updated product data.
- Please request for a specification sheet for detailed product data prior to the purchase.
- Before using the product in this catalog, please read "Precautions" and other safety precautions listed in the printed version catalog.

Toroidal Cores (Coated Type)

[RoHS Compliant]



Model	Dimensions (mm)			Frequency range		Color of coating	Compatible toroidal core (bare type)
	OD	ID	T	up to 100MHz (mainly AM band range)	up to 300MHz (mainly FM band range)		
ESD-R-12C-2	12.0	7.3	15.3		●	Blue	
ESD-R-14A	15.0	6.2	3.5	●		Green	
ESD-R-14C-2	14.0	7.0	3.0		●	Blue	ESD-R-14C
ESD-R-15C	15.2	10.5	12.5		●	Blue	ESD-R-15C-1
ESD-R-17S-1	17.7	9.4	28.8		●	Blue	ESD-R-17S
ESD-R-19E-1	19.0	10.7	5.3		●	Blue	
ESD-R-25D-8	25.0	15.0	8.0		●	Blue	
ESD-R-25L-A	25.3	15.1	12.1		●	Blue	ESD-R-25SD
ESD-R-28C-1	28.2	15.8	13.2		●	Blue	
ESD-R-31C-1	32.0	18.5	9.0		●	Green	ESD-R-31C

※Above frequency range is a reference only. Please test with actual device before use.

Shape and Dimensions

●ESD-R Series

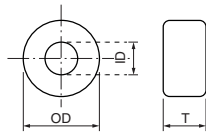

Impedance vs. Frequency

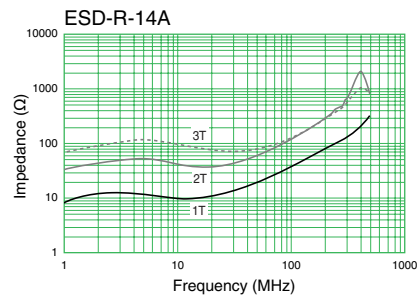
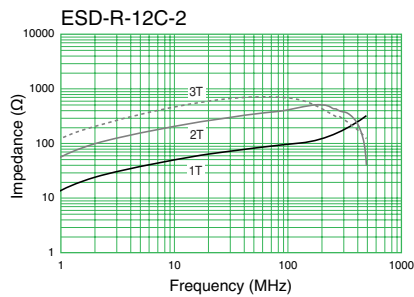

EMI Core

12



- All specifications in this catalog and production status of products are subject to change without notice. Prior to the purchase, please contact NEC TOKIN for updated product data.
- Please request for a specification sheet for detailed product data prior to the purchase.
- Before using the product in this catalog, please read "Precautions" and other safety precautions listed in the printed version catalog.

Impedance vs. Frequency

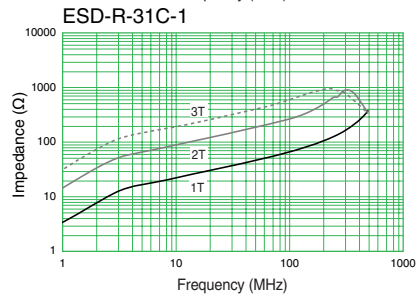
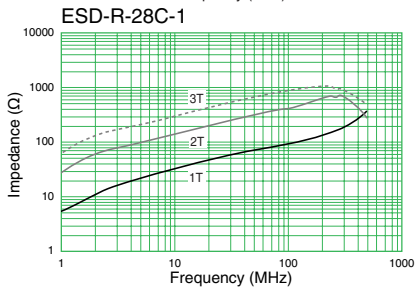
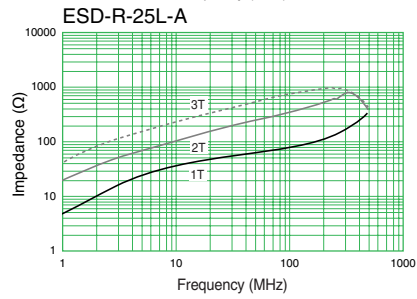
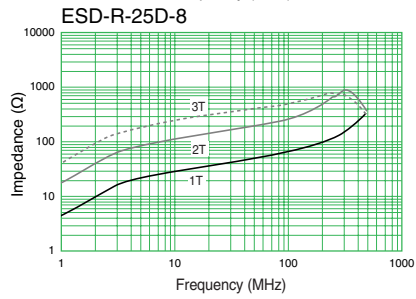
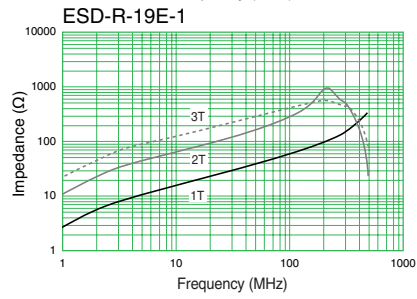
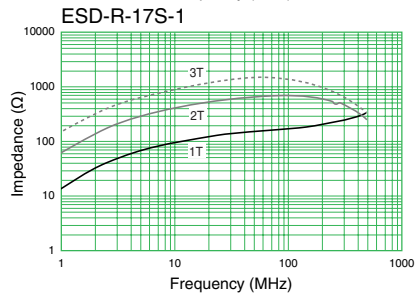
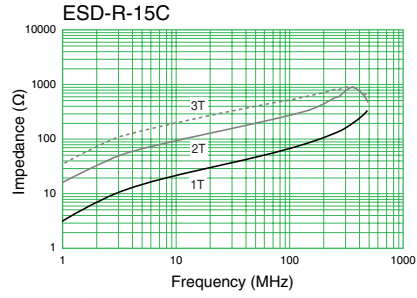
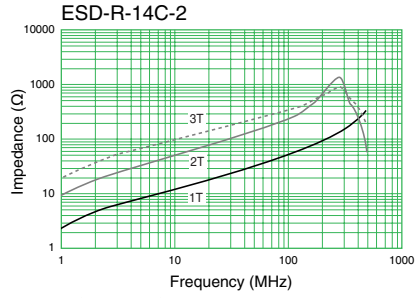

- All specifications in this catalog and production status of products are subject to change without notice. Prior to the purchase, please contact NEC TOKIN for updated product data.
- Please request for a specification sheet for detailed product data prior to the purchase.
- Before using the product in this catalog, please read "Precautions" and other safety precautions listed in the printed version catalog.

Toroidal Cores with Case

[RoHS Compliant]

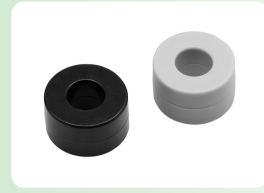

Model	Dimensions (mm)			Frequency range		Remarks	Color of case	Compatible toroidal core (bare type)
	OD	ID	T	up to 100MHz (mainly AM band range)	up to 300MHz (mainly FM band range)			
ESD-R-12D	12.9	6.0	6.4		●		black	ESD-R-12S
ESD-R-19	19.0	9.0	11.0	●			white	ESD-R-19S
ESD-R-19D	19.0	9.0	11.0		●		black	ESD-R-19SD
ESD-R-25	26.0	14.0	15.0	●			white	ESD-R-25S
ESD-R-25D	26.0	14.0	15.0		●		black	ESD-R-25SD
ESD-R-38	39.0	17.5	14.0	●			white	ESD-R-38D
ESD-R-38C-1	39.0	17.5	14.0		●	with tape(black)	white	—
ESD-R-47	48.0	25.5	16.0	●			white	—
ESD-R-47D-1	48.0	25.5	16.0		●	with tape(black)	white	—
ESD-R-57	61.0	32.4	24.0	●			white	—
ESD-R-57D-1	61.0	32.4	24.0		●	with tape(black)	white	—

※Above frequency range is a reference only. Please test with actual device before use.

※Flame resistant grade of the case : UL94V-2

Shape and Dimensions

●ESD-R Series

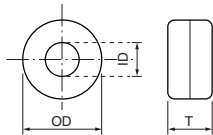

Impedance vs. Frequency

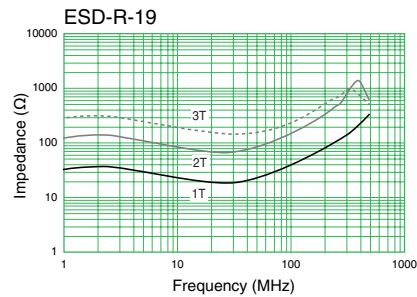
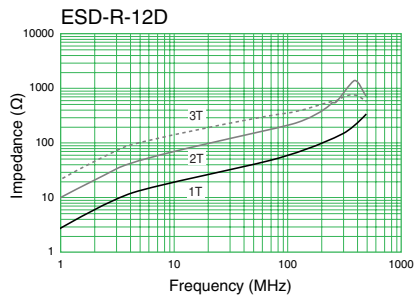

EMI Core



- All specifications in this catalog and production status of products are subject to change without notice. Prior to the purchase, please contact NEC TOKIN for updated product data.
- Please request for a specification sheet for detailed product data prior to the purchase.
- Before using the product in this catalog, please read "Precautions" and other safety precautions listed in the printed version catalog.

Impedance vs. Frequency

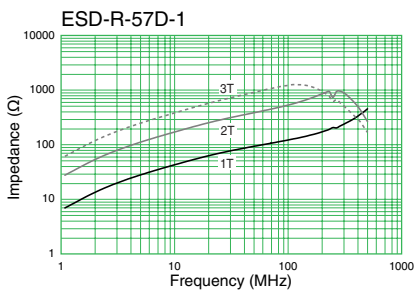
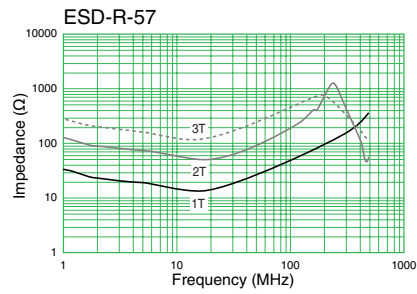
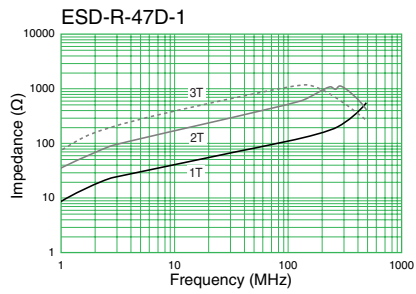
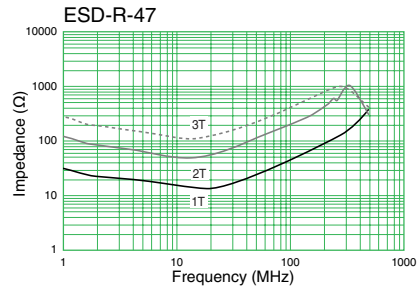
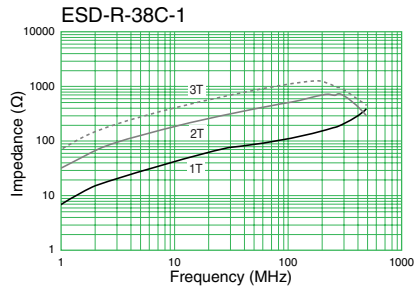
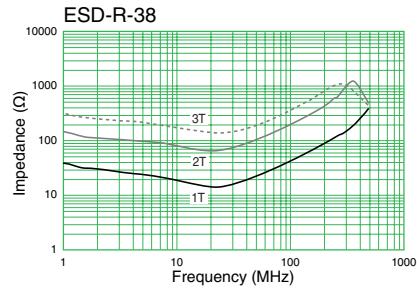
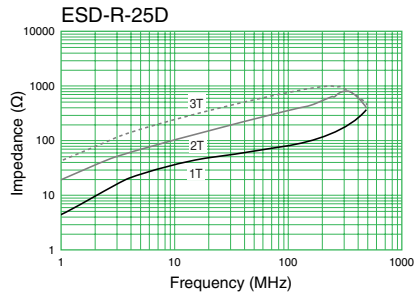
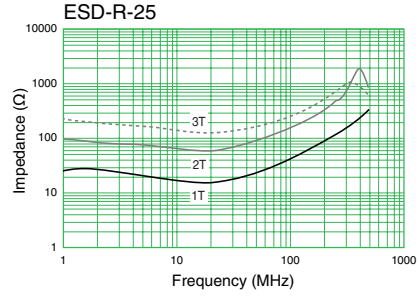
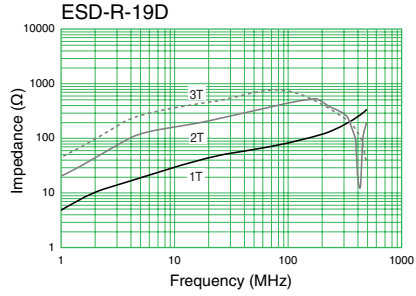

- All specifications in this catalog and production status of products are subject to change without notice. Prior to the purchase, please contact NEC TOKIN for updated product data.
- Please request for a specification sheet for detailed product data prior to the purchase.
- Before using the product in this catalog, please read "Precautions" and other safety precautions listed in the printed version catalog.

Toroidal Cores with Snail-shaped Case

[RoHS Compliant]



Model	Dimensions (mm)				Frequency range		Color of case	Compatible toroidal core (bare type)
	A	B	C	D	up to 100MHz (mainly AM band range)	up to 300MHz (mainly FM band range)		
ESD-R-19B	21.5	8.8	13.0	18.5	●		white	ESD-R-19S
ESD-R-19D-B	21.5	8.8	13.0	18.5		●	black	ESD-R-19SD
ESD-R-25B	29.3	13.9	15.0	23.0	●		white	ESD-R-25S
ESD-R-25D-B	29.3	13.9	15.0	23.0		●	black	ESD-R-25SD
ESD-R-38B	42.4	17.9	16.0	28.0	●		white	ESD-R-38D
ESD-R-38D-B	42.4	17.9	16.0	28.0		●	black	—
ESD-R-47B	51.5	25.5	17.5	34.0	●		white	—
ESD-R-47D-B	51.5	25.5	17.5	34.0		●	black	—

※Above frequency range is a reference only. Please test with actual device before use.

※Flame resistant grade of the case : UL94V-2

Shape and Dimensions

●ESD-R-B Series

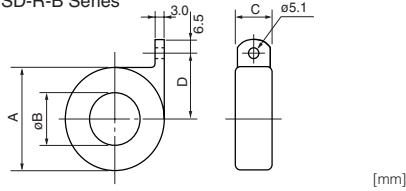

Impedance vs. Frequency

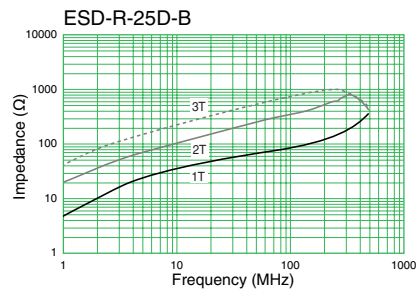
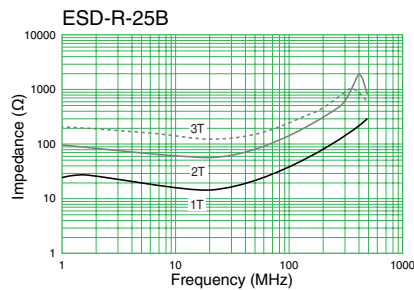
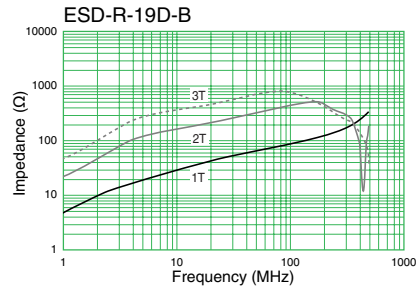
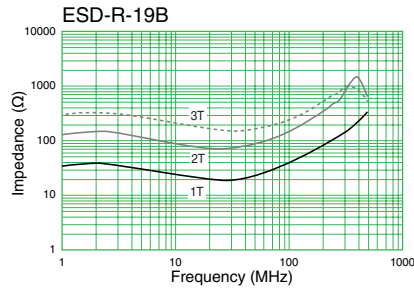

EMI Core



- All specifications in this catalog and production status of products are subject to change without notice. Prior to the purchase, please contact NEC TOKIN for updated product data.
- Please request for a specification sheet for detailed product data prior to the purchase.
- Before using the product in this catalog, please read "Precautions" and other safety precautions listed in the printed version catalog.

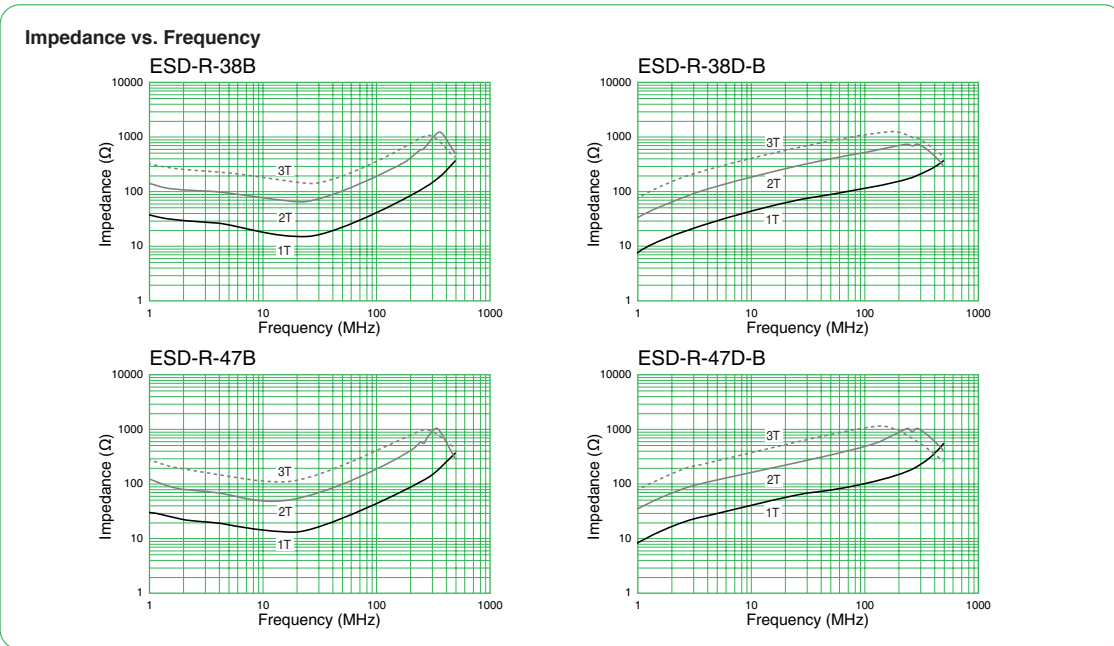

- All specifications in this catalog and production status of products are subject to change without notice. Prior to the purchase, please contact NEC TOKIN for updated product data.
- Please request for a specification sheet for detailed product data prior to the purchase.
- Before using the product in this catalog, please read "Precautions" and other safety precautions listed in the printed version catalog.

Snap-on Cores for Round Cables

[RoHS Compliant]



●ESD-SR Series

Model	Dimensions (mm)			φD	Weight (g)	Color of case
	A max.	B max.	C max.			
ESD-SR-100	16.5	16.5	21.0	Up to 6.0	7.2	Black, Gray, Violet
ESD-SR-110	14.4	14.2	28.0	Up to 5.0	6.9	Black, Gray, Violet
ESD-SR-S10	15.5	14.0	18.5	Up to 6.0	4.1	Black
ESD-SR-120	16.0	16.4	33.0	Up to 6.0	13.3	Black, Gray, Violet
ESD-SR-150	19.6	20.3	37.4	Up to 7.0	23.4	Black, Gray, Violet
ESD-SR-160	20.2	20.0	39.0	Up to 9.0	22.7	Black, Gray, Violet
ESD-SR-250	31.5	31.6	38.0	Up to 13.0	59.5	Black, Gray, Violet
ESD-SR-S16	23.0	20.0	20.5	Up to 8.0	12.9	Black
ESD-SR-S25	33.0	29.0	15.5	Up to 14.5	21.3	Black

●The Violet case is built-to-order item.

ESD-SR Series

- Temperature Index : 65°C
- Flame Class : UL94V-0
- CTI : Rank 0

Shape and Dimensions

●ESD-SR-□□□

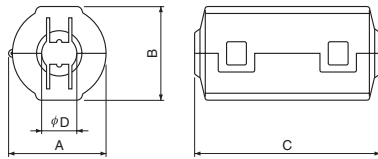

●ESD-SR-S□□

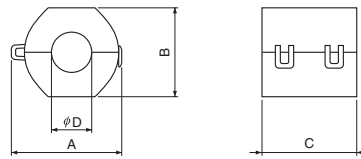

Case Color

- ESD-SR-□□□□ (blank) Black
- ESD-SR-□□□□G Gray
- ESD-SR-□□□□V Violet
- ※Black only for ESD-SR-S□□

Impedance vs. Frequency

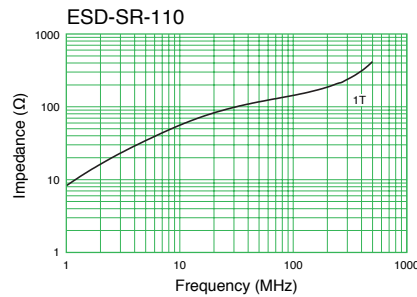
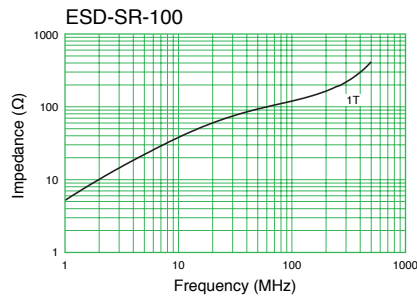

EMI Core

18



- All specifications in this catalog and production status of products are subject to change without notice. Prior to the purchase, please contact NEC TOKIN for updated product data.
- Please request for a specification sheet for detailed product data prior to the purchase.
- Before using the product in this catalog, please read "Precautions" and other safety precautions listed in the printed version catalog.

Impedance vs. Frequency

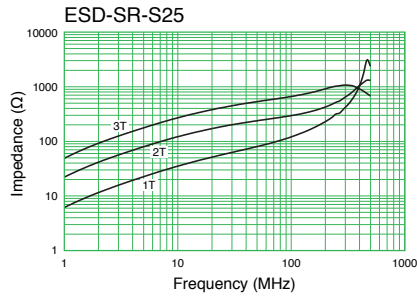
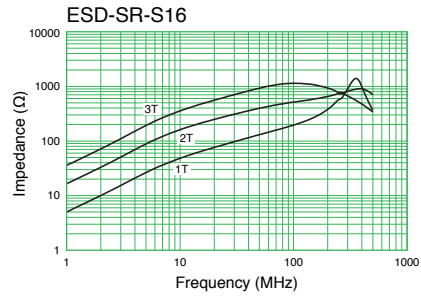
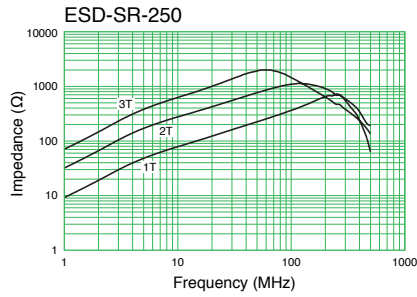
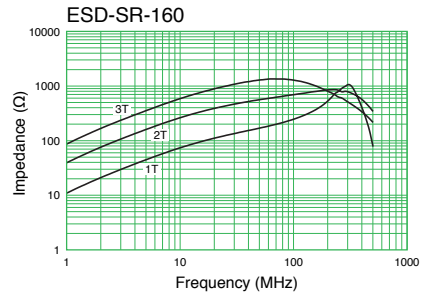
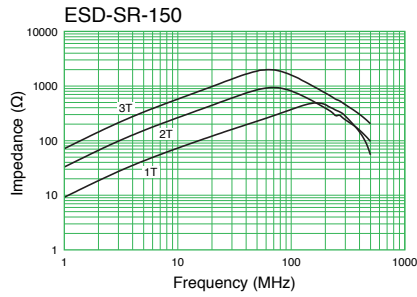
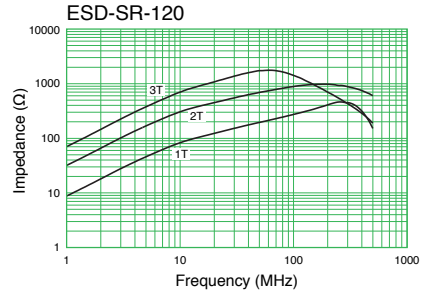
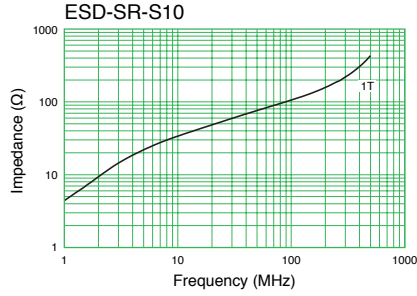

- All specifications in this catalog and production status of products are subject to change without notice. Prior to the purchase, please contact NEC TOKIN for updated product data.
- Please request for a specification sheet for detailed product data prior to the purchase.
- Before using the product in this catalog, please read "Precautions" and other safety precautions listed in the printed version catalog.

Solid / Split Cores for Flat Cables

[RoHS Compliant]



●ESD-FPL Series

Model	Dimensions (mm)					Applicable cable	shape	Remarks
	a	b	c	d	e			
ESD-FPL-14.5-3	14.5	11.0	2.75	3.0	0.80	FPC • FFC	Fig.3	Thin type
ESD-FPL-14.5-5	14.5	11.0	2.75	5.0	0.80	FPC • FFC	Fig.3	Thin type
ESD-FPL-14.5-8	14.5	11.0	2.75	8.0	0.80	FPC • FFC	Fig.3	Thin type
ESD-FPL-14.5-10	14.5	11.0	2.75	10.0	0.80	FPC • FFC	Fig.3	Thin type
ESD-FPL-16-12	16.0	11.5	4.50	12.0	0.85	8 core	Fig.3	
ESD-FPL-18-6	18.0	14.0	5.00	6.0	1.00	FPC • FFC	Fig.3	
ESD-FPL-18-8	18.0	14.0	5.00	8.0	1.00	10 core	Fig.3	
ESD-FPL-18-12	18.0	14.0	5.00	12.0	1.00	FPC • FFC	Fig.3	
ESD-FPL-18.7-3	18.7	15.0	2.75	3.0	0.70	FPC • FFC	Fig.3	Thin type
ESD-FPL-18.7-7	18.7	15.0	2.75	7.0	0.70	FPC • FFC	Fig.3	Thin type
ESD-FPL-18.7-10	18.7	15.0	2.75	10.0	0.70	FPC • FFC	Fig.3	Thin type
ESD-FPL-18.7-12	18.7	15.0	2.75	12.0	0.70	FPC • FFC	Fig.3	Thin type
ESD-FPL-21-8	21.0	17.0	5.00	8.0	0.80	FPC • FFC	Fig.3	
ESD-FPL-21.5-8	21.5	16.5	6.50	8.0	1.30	12 core	Fig.3	
ESD-FPL-23.8-7	23.8	18.8	6.30	7.0	1.10	12 core	Fig.3	
ESD-FPL-13	23.8	18.8	6.30	15.0	1.10	13 core	Fig.3	
ESD-FPL-24-8	24.0	19.0	6.50	8.0	1.30	14 core	Fig.3	
ESD-FPL-24.5-6	24.5	20.0	4.50	6.0	0.90	FPC • FFC	Fig.3	
ESD-FPL-24.5-8	24.5	20.0	4.50	8.0	0.90	FPC • FFC	Fig.3	
ESD-FPL-25-12	25.0	21.0	5.00	12.0	0.85	16 core	Fig.3	
ESD-FPL-27-8	27.0	22.0	6.50	8.0	1.30	16 core	Fig.3	
ESD-FPL-7	28.0	23.5	7.70	7.0	1.50	16 core	Fig.2	
ESD-FPL-15	28.0	23.5	7.70	14.6	1.50	16 core	Fig.2	
ESD-FPL-28-10	28.0	24.0	5.00	10.0	0.80	FPC • FFC	Fig.3	
ESD-FPL-31-9	31.0	27.0	5.00	9.0	0.55	FPC	Fig.3	Minimal gap type
ESD-FPL-31-12	31.0	27.0	5.00	12.0	0.55	FPC	Fig.3	Minimal gap type
ESD-FPL-32-8	32.0	28.0	5.00	8.0	0.80	FPC • FFC	Fig.3	
ESD-FPL-32-12	32.0	28.0	5.00	12.0	0.80	FPC • FFC	Fig.3	
ESD-FPL-20-12	33.2	27.0	8.00	12.0	1.50	20 core	Fig.3	
ESD-FPL-20-15	33.2	27.0	8.00	15.0	1.50	20 core	Fig.3	
ESD-FPL-33.5-8	33.5	27.5	6.50	8.0	1.30	20 core	Fig.3	
ESD-FPL-33.5-10	33.5	27.5	6.50	10.0	1.30	20 core	Fig.3	
ESD-FPL-33.5-12	33.5	27.5	6.50	12.0	1.30	20 core	Fig.3	
ESD-FPL-34-15	34.0	30.0	6.00	15.0	0.80	FPC • FFC	Fig.3	
ESD-FPL-35-5	35.0	30.0	8.00	5.0	1.30	22 core	Fig.3	
ESD-FPL-35-8	35.0	30.0	8.00	8.0	1.30	22 core	Fig.3	
ESD-FPL-16	37.0	25.4	12.00	12.7	1.90	16 core	Fig.1	
ESD-FPL-38-12	38.0	34.0	5.00	12.0	0.80	FPC • FFC	Fig.3	
ESD-FPL-38.5-8	38.5	35.0	4.00	8.0	0.80	FPC • FFC	Fig.3	
ESD-FPL-38.5-12	38.5	35.0	4.00	12.0	0.80	FPC • FFC	Fig.3	
ESD-FPL-40-10	40.0	34.8	6.50	10.0	1.30	26 core	Fig.3	
ESD-FPL-40-12	40.0	34.8	6.50	12.0	1.30	26 core	Fig.3	
ESD-FPL-40-15	40.0	34.8	6.50	15.0	1.30	26 core	Fig.3	
ESD-FPL-26	41.2	35.0	7.70	15.0	1.50	26 core	Fig.3	
ESD-FPL-45.2-8	45.2	40.0	6.50	8.0	1.30	30 core	Fig.3	
ESD-FPL-45-12	45.2	40.0	6.50	12.0	1.50	30 core	Fig.3	
ESD-FPL-49.6-12	49.6	44.5	6.50	12.0	1.30	32 core	Fig.3	
ESD-FPL-57.6-12	57.6	52.0	6.50	12.0	1.30	40 core	Fig.3	
ESD-FPL-34	60.0	48.5	12.00	12.7	2.20	34 core	Fig.1	
ESD-FPL-50	80.0	68.6	12.00	12.7	1.90	50 core	Fig.1	

※Other sizes available. Please contact NEC TOKIN.

EMI Core



- All specifications in this catalog and production status of products are subject to change without notice. Prior to the purchase, please contact NEC TOKIN for updated product data.
- Please request for a specification sheet for detailed product data prior to the purchase.
- Before using the product in this catalog, please read "Precautions" and other safety precautions listed in the printed version catalog.

●ESD-FPD Series

Model	Dimensions (mm)					Applicable cable	Remarks
	a	b	c	d	e		
ESD-FPD-16	37.0	25.4	10.0	12.7	2.6	16 core	Stainless steel clamp
ESD-FPD-16-1	37.0	25.4	10.0	12.7	2.6	16 core	Nylon clamp
ESD-FPD-34	60.0	48.3	10.0	12.7	2.0	34 core	Stainless steel clamp
ESD-FPD-34-1	60.0	48.3	10.0	12.7	2.0	34 core	Nylon clamp
ESD-FPD-40	68.0	56.0	10.0	12.7	2.0	40 core	Stainless steel clamp
ESD-FPD-40-1	68.0	56.0	10.0	12.7	2.0	40 core	Nylon clamp
ESD-FPD-50	80.0	68.6	10.0	12.7	2.0	50 core	Stainless steel clamp
ESD-FPD-50-1	80.0	68.6	10.0	12.7	2.0	50 core	Nylon clamp

Shape and Dimensions

●ESD-FPD Series (Core)

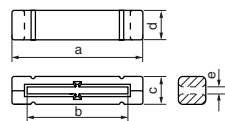

●ESD-FPD Series Clamp (Stainless steel)

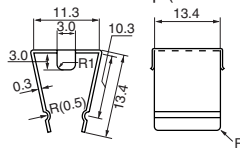

●ESD-FPD-1 Series Clamp FPD-CL-1 (Black nylon with cable stopper)

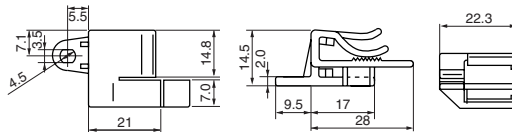

●Fig.1

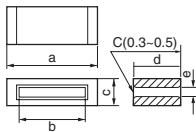

●Fig.2

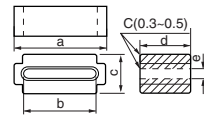

●Fig.3

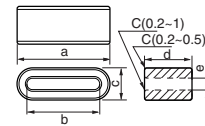

[mm]

Application Example

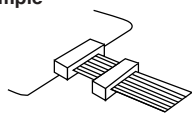

- All specifications in this catalog and production status of products are subject to change without notice. Prior to the purchase, please contact NEC TOKIN for updated product data.
- Please request for a specification sheet for detailed product data prior to the purchase.
- Before using the product in this catalog, please read "Precautions" and other safety precautions listed in the printed version catalog.

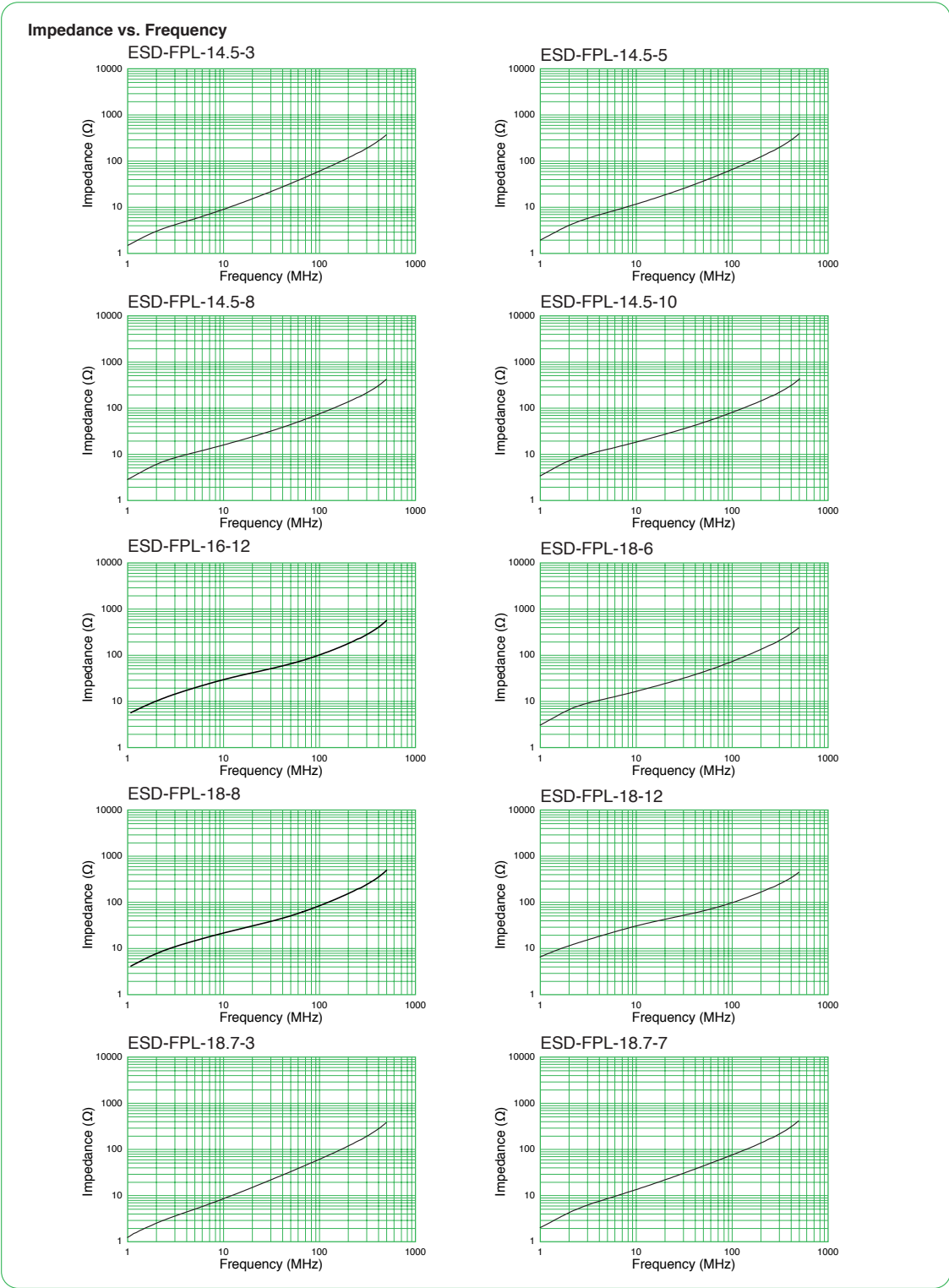

- All specifications in this catalog and production status of products are subject to change without notice. Prior to the purchase, please contact NEC TOKIN for updated product data.
- Please request for a specification sheet for detailed product data prior to the purchase.
- Before using the product in this catalog, please read "Precautions" and other safety precautions listed in the printed version catalog.

Impedance vs. Frequency

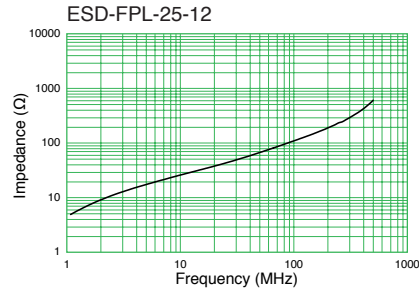
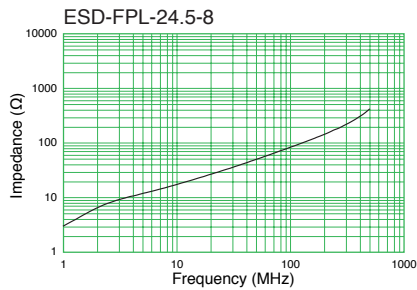
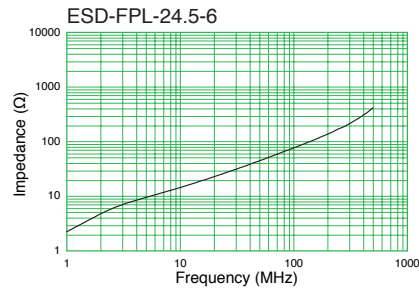
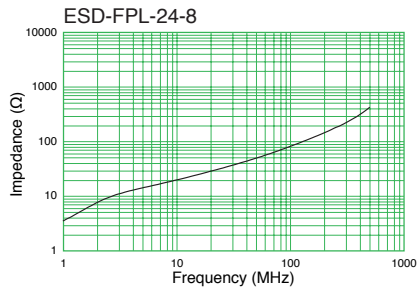
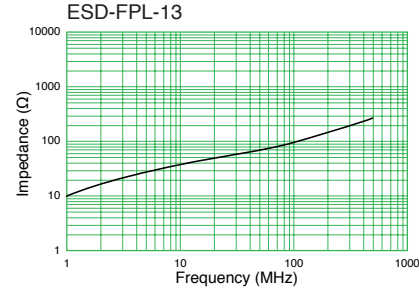
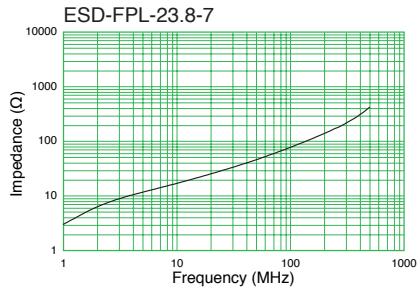
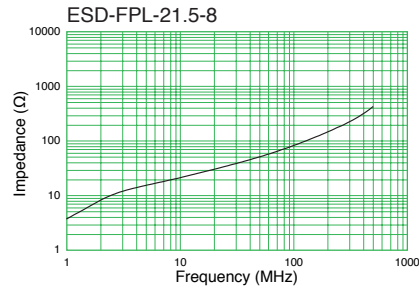
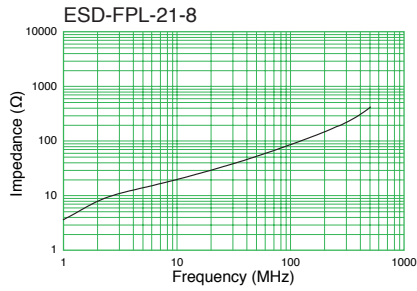
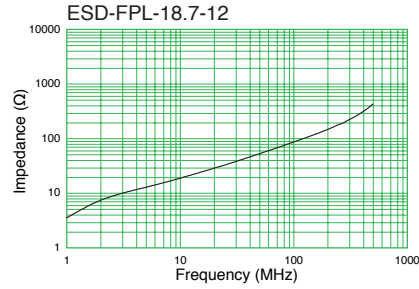
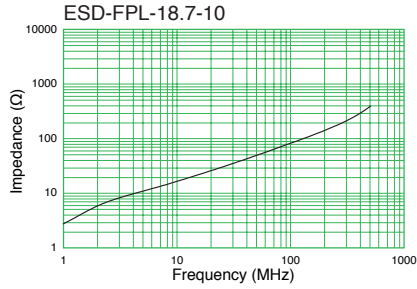

- All specifications in this catalog and production status of products are subject to change without notice. Prior to the purchase, please contact NEC TOKIN for updated product data.
- Please request for a specification sheet for detailed product data prior to the purchase.
- Before using the product in this catalog, please read "Precautions" and other safety precautions listed in the printed version catalog.

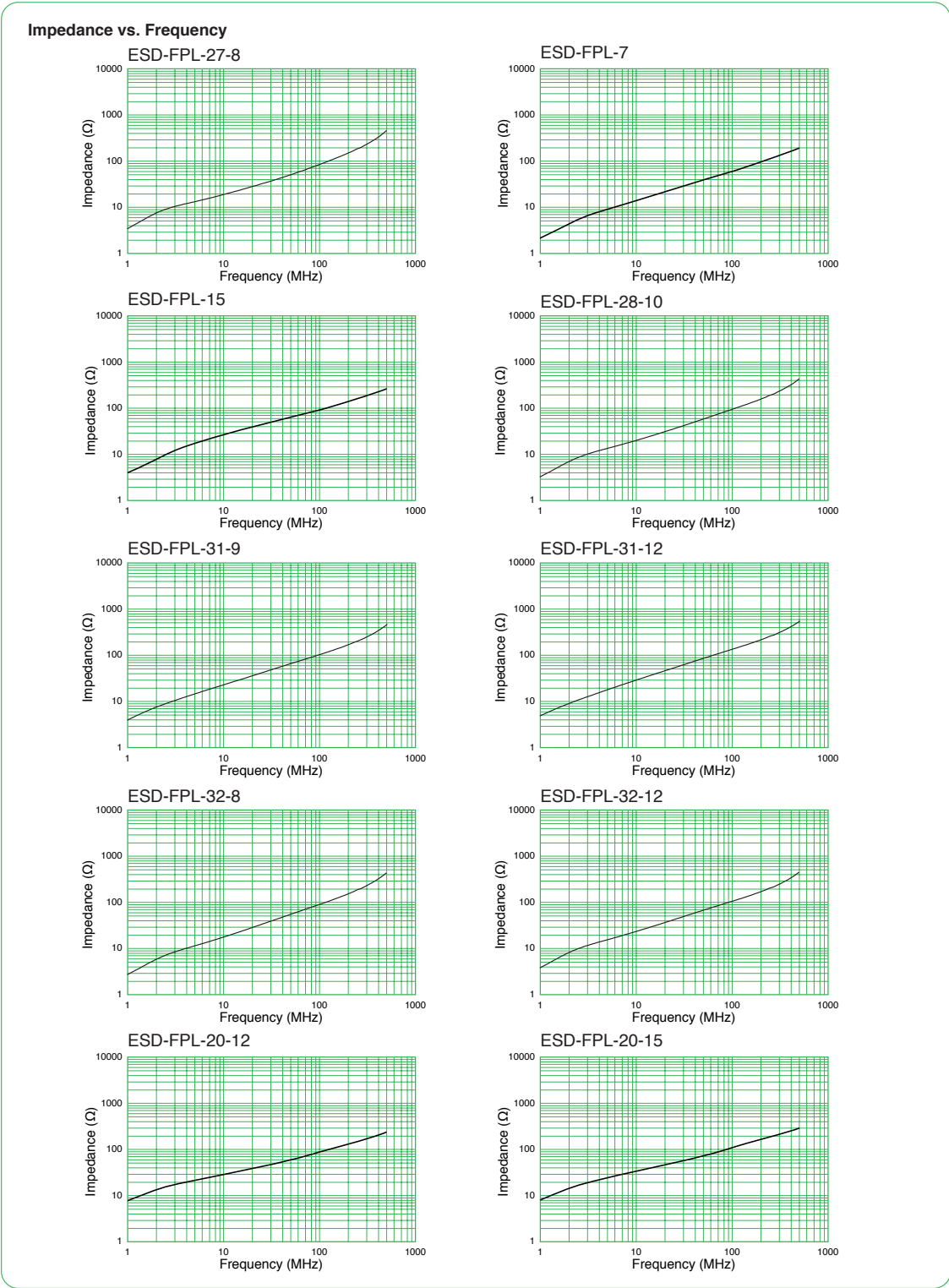

- All specifications in this catalog and production status of products are subject to change without notice. Prior to the purchase, please contact NEC TOKIN for updated product data.
- Please request for a specification sheet for detailed product data prior to the purchase.
- Before using the product in this catalog, please read "Precautions" and other safety precautions listed in the printed version catalog.

Impedance vs. Frequency

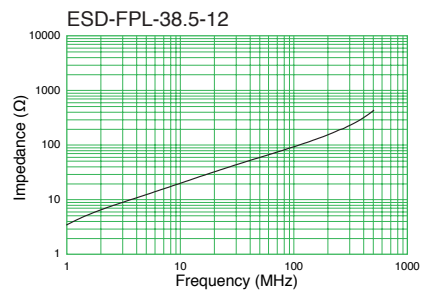
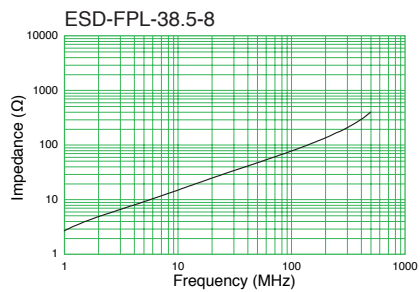
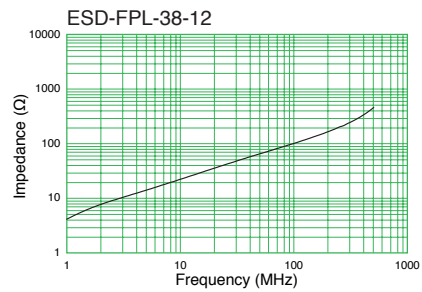
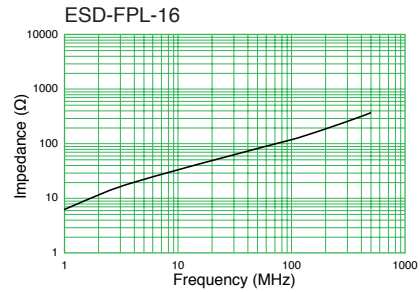
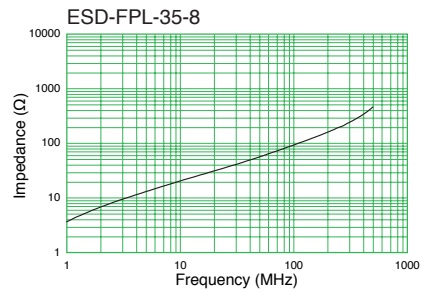
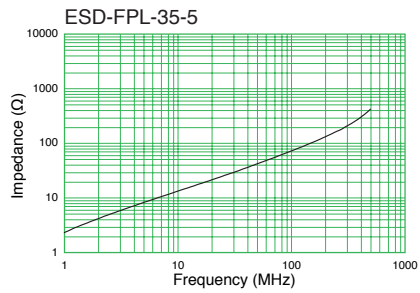
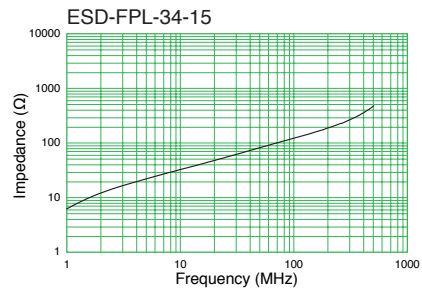
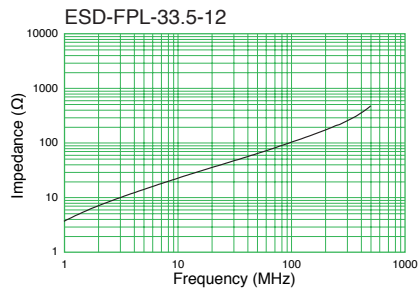
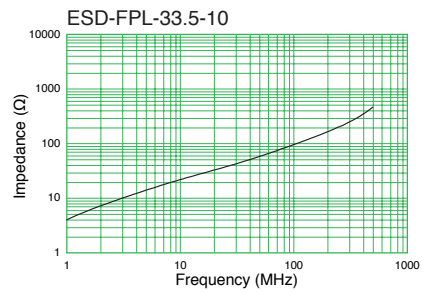
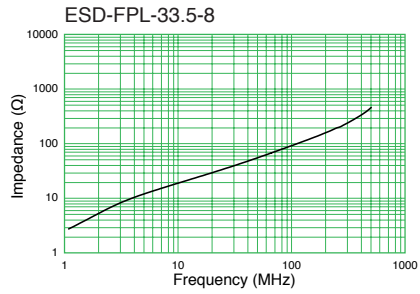

- All specifications in this catalog and production status of products are subject to change without notice. Prior to the purchase, please contact NEC TOKIN for updated product data.
- Please request for a specification sheet for detailed product data prior to the purchase.
- Before using the product in this catalog, please read "Precautions" and other safety precautions listed in the printed version catalog.

Impedance vs. Frequency

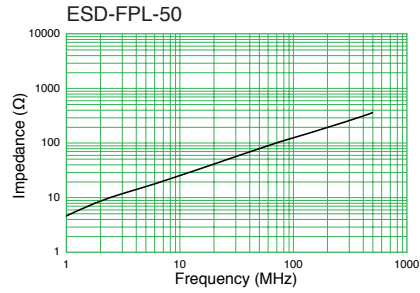
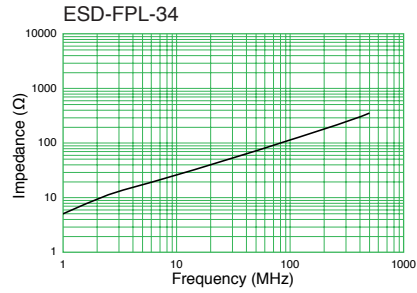
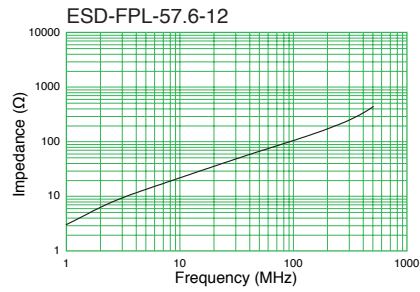
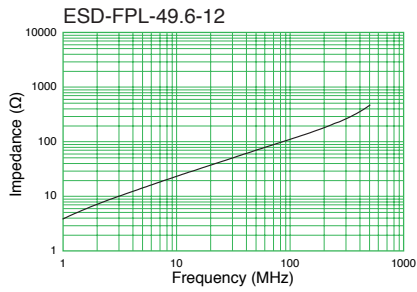
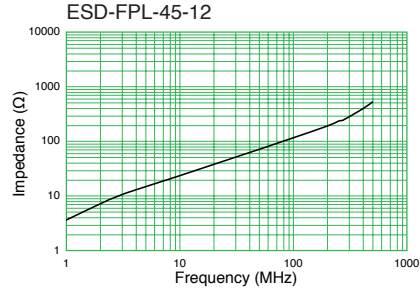
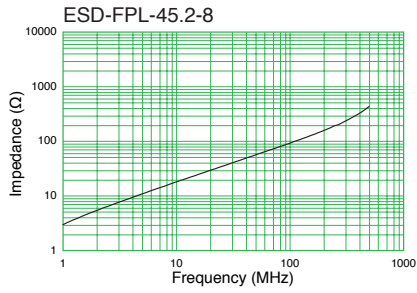
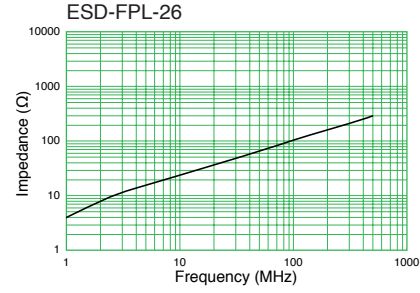
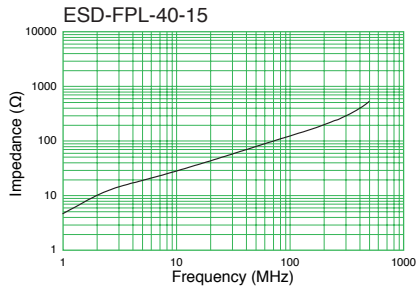
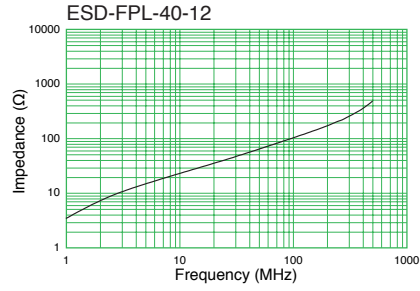
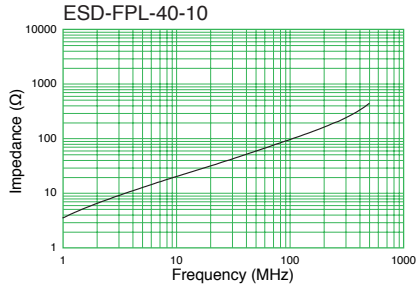

- All specifications in this catalog and production status of products are subject to change without notice. Prior to the purchase, please contact NEC TOKIN for updated product data.
- Please request for a specification sheet for detailed product data prior to the purchase.
- Before using the product in this catalog, please read "Precautions" and other safety precautions listed in the printed version catalog.

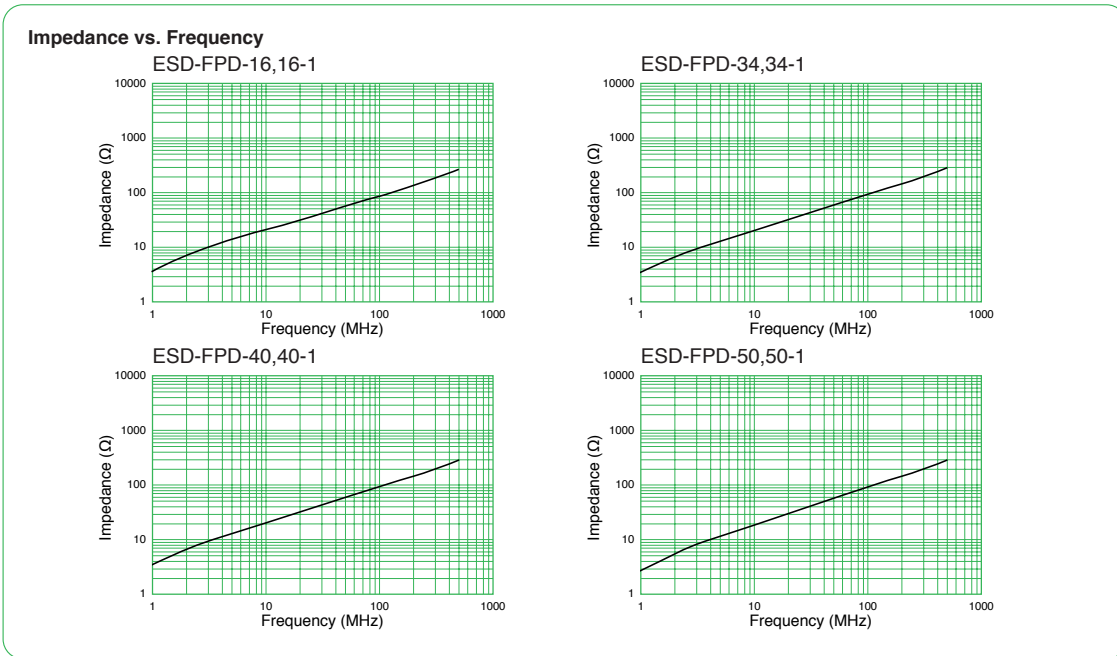

- All specifications in this catalog and production status of products are subject to change without notice. Prior to the purchase, please contact NEC TOKIN for updated product data.
- Please request for a specification sheet for detailed product data prior to the purchase.
- Before using the product in this catalog, please read "Precautions" and other safety precautions listed in the printed version catalog.

Bead Cores

[RoHS Compliant]



Model	Dimensions (mm)			Frequency range		Remarks
	OD	ID	H	up to 100MHz (mainly AM band range)	up to 300MHz (mainly FM band range)	
B-20F-28	2.8	1.3	3.0	●		
B-20F-38	3.8	1.5	4.3	●		
B-20F-46	4.6	1.5	4.3	●		
B-20F-57	5.7	1.5	8.0	●		
B-20L-25	2.5	1.0	1.2		●	
B-20L-34	3.4	0.8	4.4		●	
B-20L-44	4.4	1.6	7.0		●	
B-20L-48B	4.8	2.4	4.8		●	
B-20L-95B	9.7	4.8	4.2		●	(coated)

※Above frequency range is a reference only. Please test with actual device before use.

Shape and Dimensions

●Beads Cores

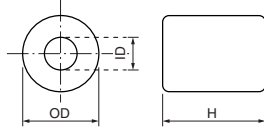

Impedance vs. Frequency

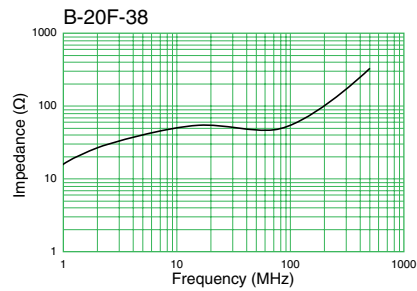
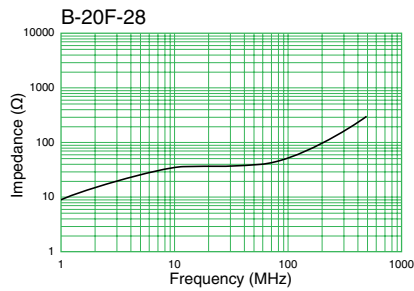

- All specifications in this catalog and production status of products are subject to change without notice. Prior to the purchase, please contact NEC TOKIN for updated product data.
- Please request for a specification sheet for detailed product data prior to the purchase.
- Before using the product in this catalog, please read "Precautions" and other safety precautions listed in the printed version catalog.

Impedance vs. Frequency

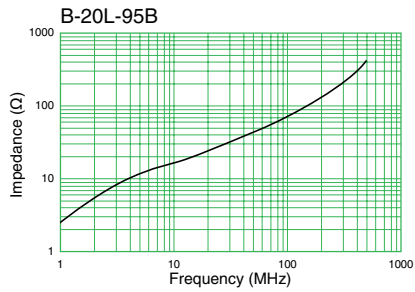
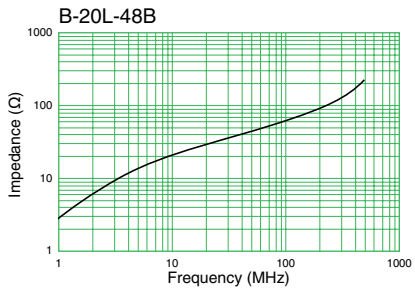
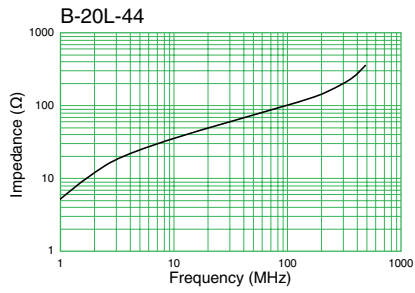
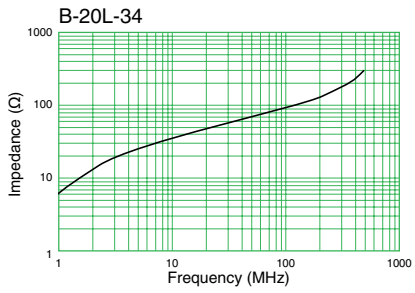
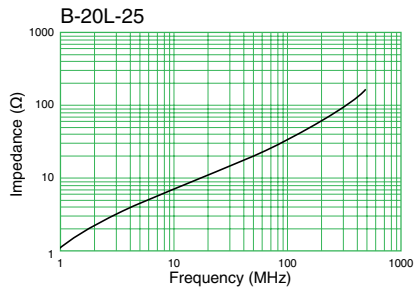
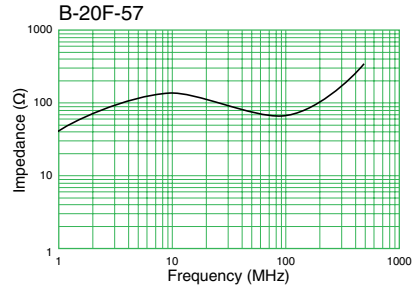
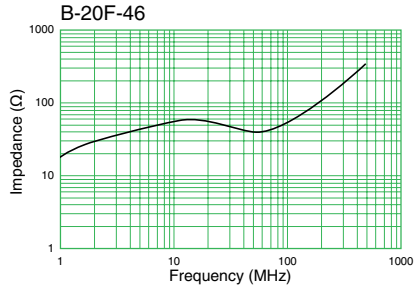

- All specifications in this catalog and production status of products are subject to change without notice. Prior to the purchase, please contact NEC TOKIN for updated product data.
- Please request for a specification sheet for detailed product data prior to the purchase.
- Before using the product in this catalog, please read "Precautions" and other safety precautions listed in the printed version catalog.



- All specifications in this catalog and production status of products are subject to change without notice. Prior to the purchase, please contact NEC TOKIN for updated product data.
- Please request for a specification sheet for detailed product data prior to the purchase.
- Before using the product in this catalog, please read "Precautions" and other safety precautions listed in the printed version catalog.

Precautions



- The names of the products and the specifications in this catalog are subject to change without notice for the sake of improvement. The manufacturer also reserves the right to discontinue any of these products. At the time of delivery, please ask for specifications sheets to check the contents in order to use the products properly and safely.
- Descriptions in this catalog regarding product characteristics and quality are based solely on discrete components. When using these components, be sure to check the specifications with the component in question mounted on the products.
- The manufacturer's warranty will not cover any disadvantage or damage caused by improper use of the products that deviates from the characteristics, specifications, or conditions for use described in this catalog.
- The products in this catalog are intended for use in ordinary electronic products. If any of these products are to be used in special applications requiring extremely high reliability, such as in aviation equipment and nuclear power controllers where product defects might pose a safety risk, please consult your NEC TOKIN sales representatives.
- Though the manufacturer has taken all possible precautions to ensure the quality and reliability of its products, improper use of products may result in bodily injury, fire, or similar accident. If you have any questions regarding the use of the products in question, please consult your NEC TOKIN sales representatives.
- Please be advised that the manufacturer accepts no responsibility for any infraction by users of the manufacturer's products on third party patents or industrial copyrights. The manufacturer is responsible only when such infractions are attributable to the structural design of the product and its manufacturing process.
- Export Control
For customers outside Japan
NEC TOKIN products should not be used or sold for use in the development, production, stockpiling or utilization of any conventional weapons or mass-destructive weapons (nuclear weapons, chemical or biological weapons, or missiles), or any other weapons.
For customers in Japan
For products which are controlled items subject to the "Foreign Exchange and Foreign Trade Law" of Japan, the export license specified by the law is required for export.
- This catalog is current as of March 2010.



- All specifications in this catalog and production status of products are subject to change without notice. Prior to the purchase, please contact NEC TOKIN for updated product data.
- Please request for a specification sheet for detailed product data prior to the purchase.
- Before using the product in this catalog, please read "Precautions" and other safety precautions listed in the printed version catalog.