

UTC2SD880

NPNEPITAXIAL PLANAR TRANSISTOR

NPN EPITAXIAL TRANSISTOR

DESCRIPTION

The UTC 2SD880 is designed for audio frequency power amplifier applications.

FEATURE

- *High DC Current Gain:
hFE=300(Max.)(VCE=5V, IC=0.5A)
- *Low Saturation Voltage:
VCE(sat)=1.0V(Max.)(IC=3A, IB=0.3A)
- *High Power Dissipation:
PC=30W (Ta=25°C)
- *Complementary to 2SB834

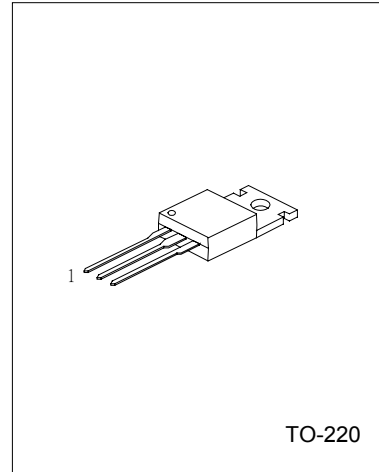

TO-220

1:BASE 2:COLLECTOR 3:EMITTER

*Pb-free plating product number: 2SD880L

ABSOLUTE MAXIMUM RATINGS (Ta=25°C)

PARAMETER	SYMBOL	VALUE	UNIT
Maximum Voltages and currents			
Collector to Base Voltage	VCBO	60	V
Collector to Emitter Voltage	VCEO	60	V
Emitter to Base Voltage	VEBO	7	V
Collector Current	IC	3	A
Base Current	IB	0.5	A
Maximum Power Dissipation			
Total Power Dissipation	PD	30	W
Maximum Temperature			
Junction Temperature Range	T _{OPR}	150	°C
Storage Temperature Range	T _{STG}	-55 ~ +150	°C

ELECTRICAL CHARACTERISTICS(Ta=25°C)

PARAMETER	SYMBOL	TEST CONDITIONS	MIN.	TYP.	MAX.	UNIT
Collector-Emitter Breakdown Voltage	BVCEO	IC=50mA, IE=0	60			V
Collector Cut-Off Current	ICBO	VCE=60V, IE=0			100	μA
Emitter Cut-Off Current	IEBO	VEB=7V, IC=0			100	μA
Collector-Emitter Saturation Voltage	VCE(SAT)	IC=3A, IB=300mA			1	V
Base-Emitter Saturation Voltage	VBE(ON)	VCE=5V, IC=500mA			1	V
DC Current Gain	hFE	IC=500mA, VCE=5V	60		300	
Current gain bandwidth product	fT	VCE=5V, IC=500mA		3		MHZ

CLASSIFICATION of hFE

RANK	O	Y	GR
RANGE	60-120	100-200	150-300

TYPICAL CHARACTERISTICS

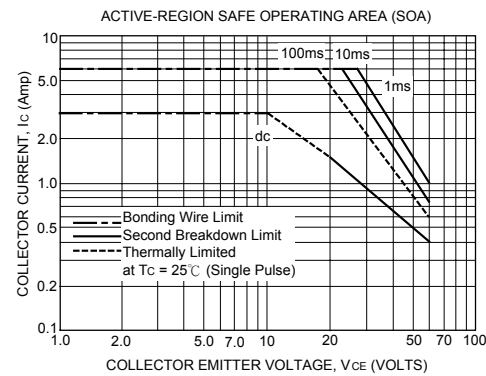
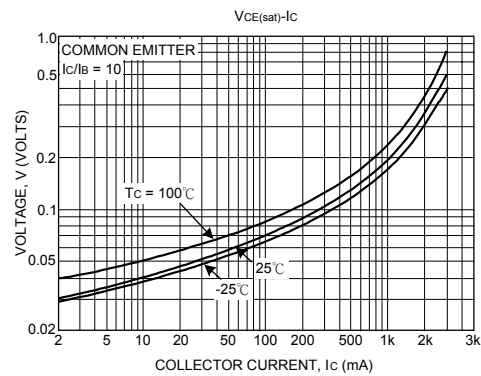
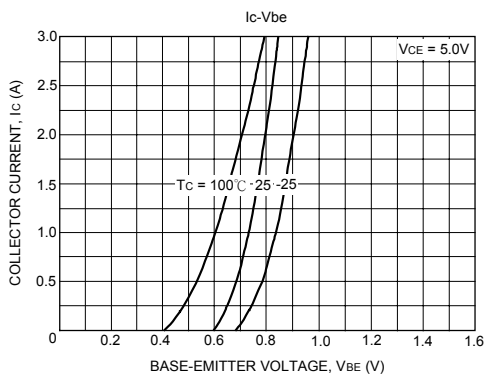
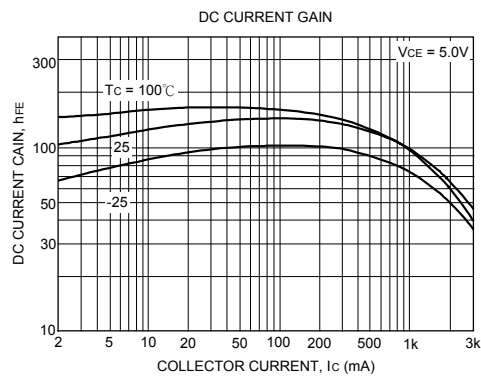
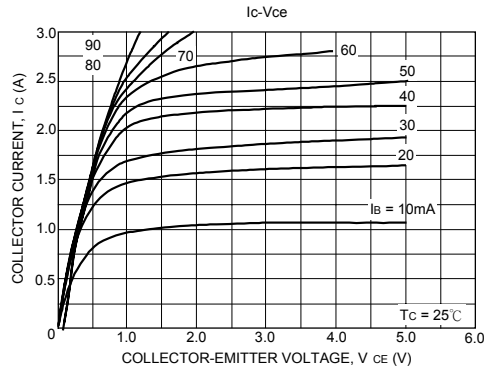
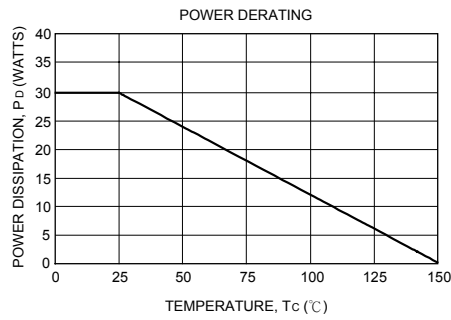

UTC assumes no responsibility for equipment failures that result from using products at values that exceed, even momentarily, rated values (such as maximum ratings, operating condition ranges, or other parameters) listed in products specifications of any and all UTC products described or contained herein. UTC products are not designed for use in life support appliances, devices or systems where malfunction of these products can be reasonably expected to result in personal injury. Reproduction in whole or in part is prohibited without the prior written consent of the copyright owner. The information presented in this document does not form part of any quotation or contract, is believed to be accurate and reliable and may be changed without notice.