

# UBA20271/2

## 350 V and 600 V Power ICs for dimmable compact fluorescent lamps

Rev. 2.1 — 12 October 2011

Product data sheet

## 1. General description

---

The UBA20271/2 are high-voltage power ICs intended to drive and control higher powered self ballasted Compact Fluorescent Lamp (CFL) lighting applications. The UBA20271/2 operate from 120 V and 230 V. The module includes a half-bridge power circuit of two NMOST power FETs. In addition, a controller circuit is included that has advanced features for dimming and a lamp current controlled boost feature. The boost feature is used for boosting cold (amalgam) CFL.

The controller contains a half-bridge drive function for CFL, a high-voltage level-shift circuit with integrated bootstrap diode. In addition, the controller contains an oscillator function, a current control function both for preheat and burn, a timer function and protection circuits. The UBA20271/2 are supplied via a  $dV/dt$  current charge supply circuit from the half-bridge circuit.

**Remark:** Mains voltages noted are AC.

## 2. Features and benefits

---

### 2.1 Half-bridge features

- UBA20271: Two internal 350 V, 1.0  $\Omega$ , max 5.0 A NMOST half-bridge power FETs
- UBA20272: Two internal 600 V, 3.0  $\Omega$ , max 2.7 A NMOST half-bridge power FETs
- Integrated high-voltage level-shift function with integrated bootstrap diode

### 2.2 Preheat and ignition features

- Coil saturation protection during ignition
- Adjustable saturation protection level
- Adjustable preheat time
- Adjustable preheat current
- Ignition lamp current detection

### 2.3 Lamp boost features

- Adjustable boost timing
- Fixed boost current ratio of 1.5
- Gradually boost to burn transition timing

### 2.4 Dim features

- Continuously variable dimming function for standard phase cut dimmers



- Natural dimming curve by logarithmic correction
- Adjustable Minimum Dimming Level (MDL)
- Controlled lamp ON/OFF

## 2.5 Protection

- OverCurrent Protection (OCP) in boost and burn state
- Capacitive Mode Protection (CMP)
- OverPower Protection (OPP)
- Power-down function
- OverTemperature Protection (OTP)

## 2.6 Other features

- Current controlled operating in boost and burn state
- External power-down function
- Lamp flicker suppression

## 3. Applications

- Dimmable compact fluorescent lamps for power levels from 5 W to 20 W directly operating from 230 V (UBA20272) and 120 V (UBA20271) mains voltage.

## 4. Ordering information

Table 1. Ordering information

Type number	Package		
	Name	Description	Version
UBA20271T/N1	SO20	Plastic small outline package; 20 leads; body width 7.5 mm	SOT163-1
UBA20272T/N1	SO20	Plastic small outline package; 20 leads; body width 7.5 mm	SOT163-1

### 5. Block diagram

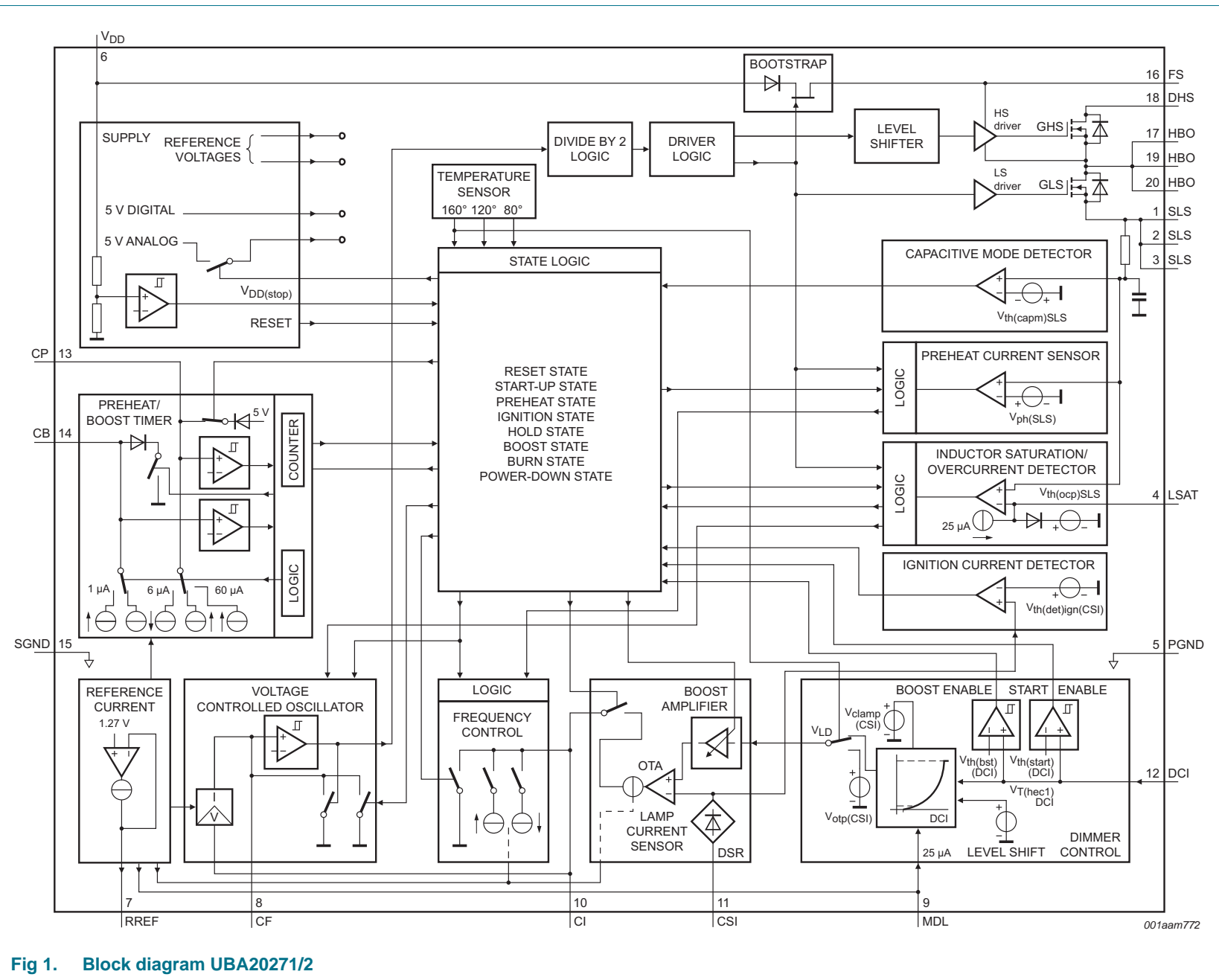

Fig 1. Block diagram UBA20271/2

## 6. Pinning information

### 6.1 Pinning

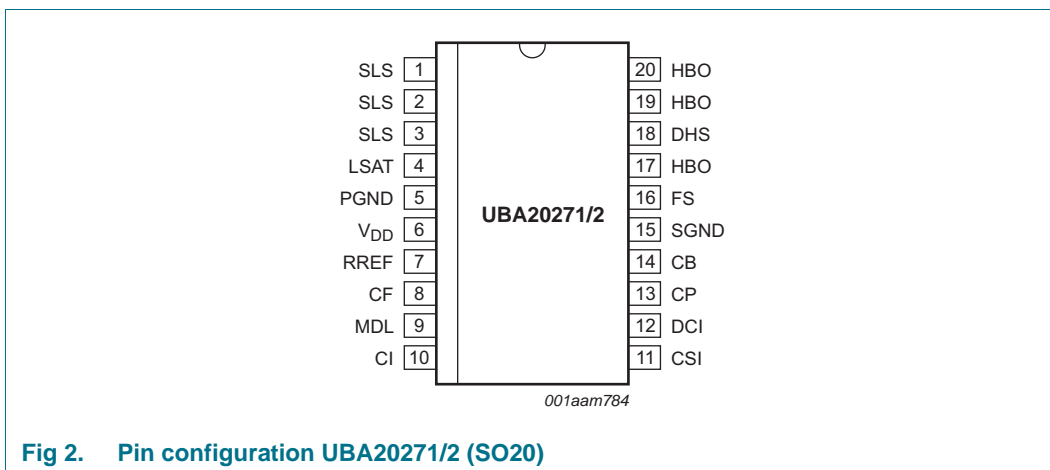

Fig 2. Pin configuration UBA20271/2 (SO20)

### 6.2 Pin description

Table 2. Pin description

Symbol	Pin	Description
SLS	1,2,3	source low-side switch <sup>[1]</sup>
LSAT	4	coil saturation level input
PGND	5	power ground <sup>[3]</sup>
V <sub>DD</sub>	6	low voltage supply
RREF	7	internal reference current input
CF	8	voltage controlled oscillator capacitor
MDL	9	minimum dimming level input
CI	10	voltage controlled oscillator input integrating capacitor
CSI	11	current feedback sense input
DCI	12	dimming level input
CP	13	preheat timing capacitor
CB	14	boost timing capacitor
SGND	15	signal ground <sup>[3]</sup>
FS	16	floating supply voltage
HBO	17,19,20	half-bridge output <sup>[2]</sup>
DHS	18	high-voltage supply

[1] SLS pins are internally connected

[2] HBO pins are internally connected

[3] PGND and SGND are internally connected

## 7. Functional description

The UBA20271/2 are ICs with integrated half-bridge MOSFETs in self ballasted high-power CFL and their derivatives. The UBA20271/2 are equipped with variable dimming functionality that has a logarithmic corrected natural dimming function. This function enables a less sensitive brightness control of the lamp at low dim levels.

The UBA20271/2 are rated up to a maximum continuous rectified mains voltage of 350 V or 500 V, respectively and lamp power up to 20 W. The UBA20271/2 include all the necessary functions for preheat, ignition, boost, and on-state operation of the lamp and includes a linear dimming feature. In addition, several protection measures are included that safeguard the functioning of the CFL and controller. The controller states are shown in [Figure 3](#).

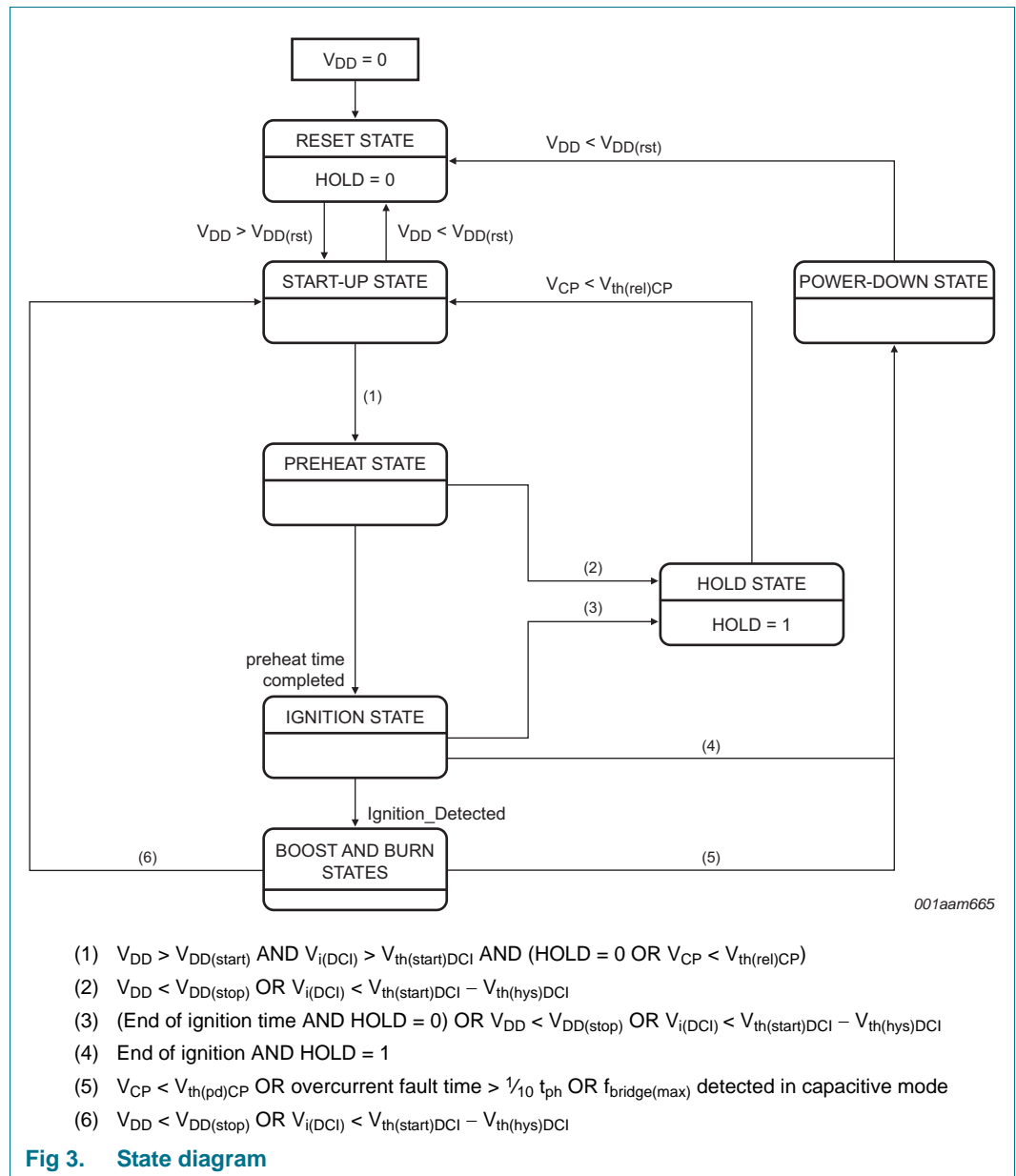

## 7.1 Lamp start-up cycle

### 7.1.1 Reset state

The UBA20271/2 are in a reset state while the supply voltage on the  $V_{DD}$  pin is lower than the  $V_{DD(rst)}$  level. In the reset state, a part of the internal supply is turned off, all registers, counters and timers are undefined. In addition, the hold state latch is reset and both the high and low-side transistor are non-conductive. During power-up, the low voltage supply capacitor on the  $V_{DD}$  pin is charged via an external start-up resistor. When the voltage on the  $V_{DD}$  pin is higher than the  $V_{DD(rst)}$  level, the start-up state is entered. The UBA20271/2 enters the reset state when the supply voltage on the  $V_{DD}$  pin drops lower than  $V_{DD(rst)}$ .

### 7.1.2 Start-up state

Start-up is achieved by charging the low voltage supply capacitor on the  $V_{DD}$  pin via an external start-up resistor. At start-up the High-Side (HS) transistor is non-conductive and the Low-Side (LS) is conductive to enable charging of the bootstrap capacitor. This capacitor supplies the HS driver and level shifter circuit connected between the FS and HBO pin. A DC reset circuit is incorporated in the ICs HS driver. This circuit ensures that lower than the lockout voltage on the FS pin the output voltage ( $V_{GHS} - V_{HBO}$ ) is zero.

As the start-up state is entered, the circuit only starts oscillating when the low voltage supply ( $V_{DD}$ ) reaches the value of  $V_{DD(start)}$  AND  $V_{i(DCI)} > V_{th(start)DCI}$ . The circuit starts oscillating at  $f_{bridge(max)}$ .

The circuit enters the preheat state as soon as the capacitor on the CP pin is charged to a voltage level higher than  $V_{th(CP)max}$ . To remain oscillating, the  $V_{DD}$  voltage must remain higher than  $V_{DD(stop)}$  and lower than the upper limit  $V_{DD(clamp)}$ . In addition, the typical voltage level on the DCI pin must be higher than  $V_{th(start)DCI} - V_{th(hys)DCI} = 0.24$  V.

An UnderVoltage LockOut (UVLO) is implemented on the DCI pin to create a guaranteed turn-off for multiple lamps when the lamps are at low dim levels. The UVLO also guarantees that there is a preheat phase when the dim level is turned up again.

The typical turn-on level on the DCI pin is set to lower than  $V_{th(start)DCI} = 0.36$  V, else it would increase the turn-on hysteresis of the lamp. This level enables the UBA20271/2 to perform a stable ignition of the lamp when there is already sufficient power from the dimmer at lower dim levels.

During the start-up state, the voltage on the CF pin is at zero and the CB pin is close to zero. The voltage on the CP pin rises to higher than  $V_{th(CP)max}$  level during the start-up state. See [Figure 9](#).

### 7.1.3 Preheat state

Starting at  $f_{bridge(max)}$ , the frequency decreases by charging capacitor  $C_{CI}$  via an output current circuit controlled by the preheat current sensor circuit. This state continues until the momentary value of the voltage across sense resistor  $R_{SLS}$  reaches the internally fixed preheat voltage level (SLS pin). At this level, the current of the preheat current sensor reaches a charge and discharge balanced state on capacitor  $C_{CI}$  to set the frequency.

The preheat time consists of eight saw-toothed pulses at the CP pin. Preheat begins as soon as the capacitor on the CP pin is charged to a voltage higher than  $V_{th(CP)max}$ . During the preheat time, the current feedback sensor circuit (input CSI pin) is disabled. To increase noise immunity, an internal filter of 30 ns is included at the SLS pin.

If during preheat, the level on the DCI pin drops lower than  $V_{th(start)DCI} - V_{th(hys)DCI} = 0.24\text{ V}$  or the  $V_{DD}$  pin drops lower than  $V_{DD(stop)}$ , the preheat state is immediately stopped. The circuit then enters the hold state delaying a new preheat cycle. A fixed voltage drop on the preheat capacitor  $C_{CP}$  and a fixed discharge current on the CP pin sets the delay time.

A new preheat cycle starts after the CP pin level slowly discharges. This condition continues until  $V_{CP} < V_{th(rel)CP}$  and recharges higher than  $V_{th(CP)max}$  provided  $V_{DD} > V_{DD(start)}$  AND  $V_{i(DCI)} > V_{th(start)DCI}$ . See [Figure 5](#).

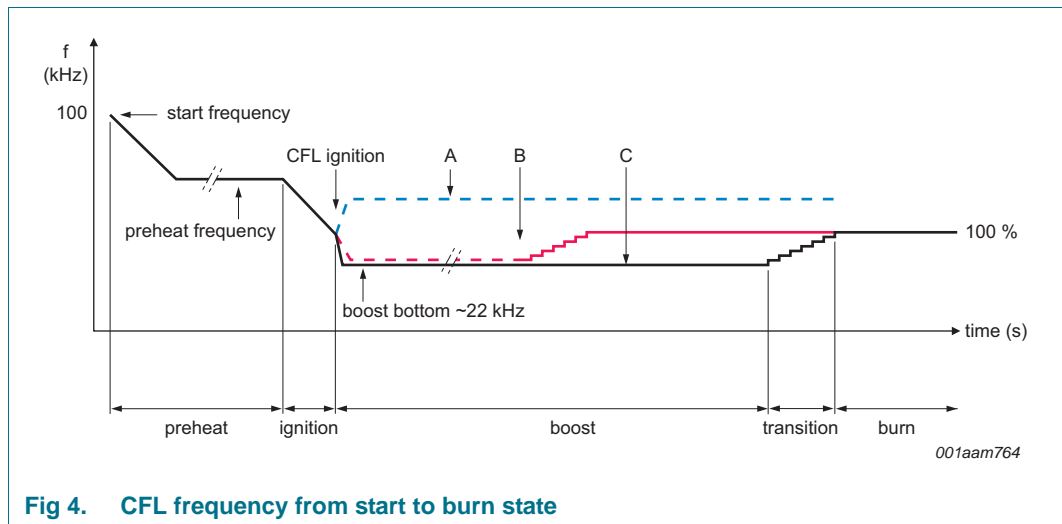

Fig 4. CFL frequency from start to burn state

### 7.1.4 Ignition state

Directly after the preheat state has been completed, the ignition state is entered. In the ignition state, the frequency sweeps down due to charging of the capacitor  $C_{CI}$  on the CI pin with an internally fixed current. See [Figure 4](#). During this continuous decrease in frequency, the circuit approaches the resonant frequency of the resonant tank L2, C5. This results in a high voltage across the lamp to ignite the lamp. The current sensor circuit which monitors the voltage over resistor  $R_{CSI}$  detects lamp ignition. See [Figure 11](#).

If the voltage on the CSI pin is above the typical ignition detection threshold voltage level of 0.6 V, lamp ignition is detected. The system then changes from ignition state to the boost or burn state. If no ignition is detected, the frequency decreases further to the minimum half-bridge frequency  $f_{bridge(min)}$ . To prevent continuous ignition attempts and over-heating of the application due to lamp damage, the UBA20271/2 only attempts to ignite the lamp twice after power-up. The ignition attempt counter is incremented when the lamp ignition threshold voltage on the CSI pin is not exceeded at the end of the ignition enabling time. If a second ignition attempt also exceeds the ignition time-out period, the IC enters the power-down state. See [Figure 5](#).

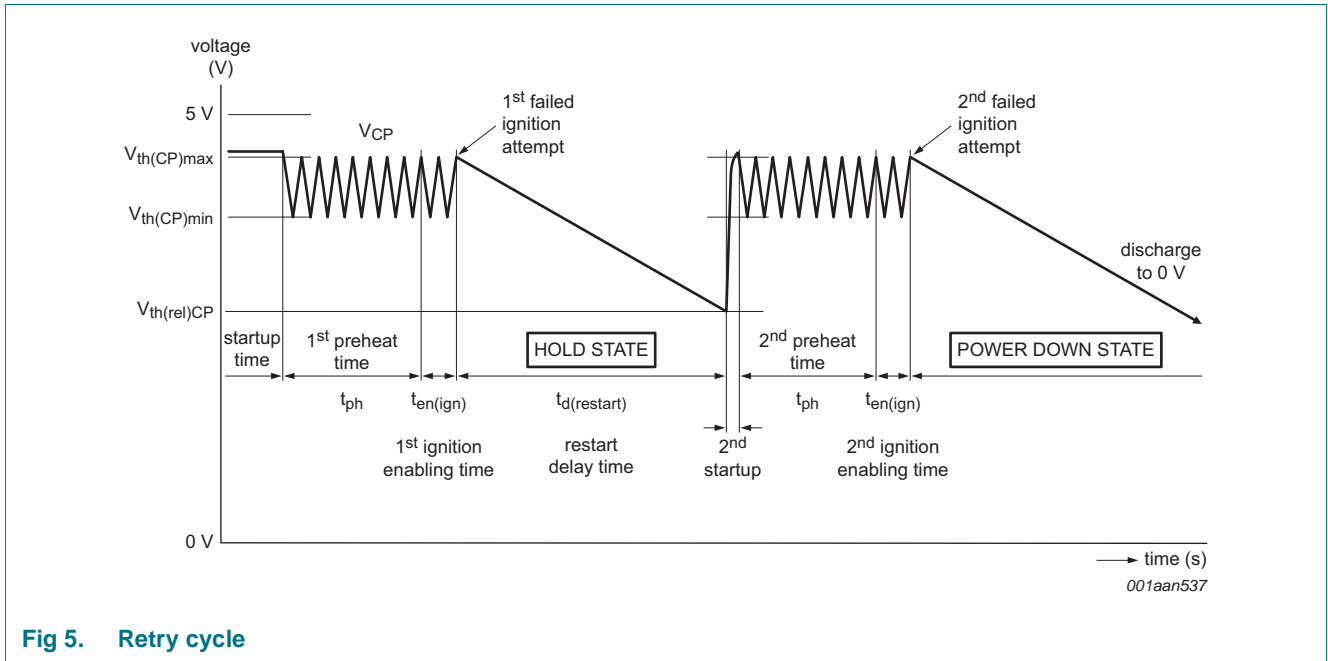

Fig 5. Retry cycle

7.1.5 Boost state and transition to burn state

When ignition is detected by measuring lamp current on the CSI pin, the circuit enters the boost state. Figure 7 shows the boost and burn state in more detail. In the boost state, the nominal burn state lamp current can be increased with a fixed boost ratio of 1.5:1. This boosts up the slow luminescence increase of a cold amalgam CFL lamp, provided  $V_{DCI} > V_{th(bst)DCI}$ . If the IC is at a temperature ( $T_{j(bp)bst}$ ) before entering the boost state, the burn state is bypassed.

A boost timing circuit is included to determine the boost time and transition to burn time. The circuit consists of a clock generator comprising  $C_{CB}$ ,  $R_{ext(RREF)}$  and a 64-step counter. When the timer is not operating,  $C_{CB}$  is discharged to lower than the  $V_{th(CB)min}$  level of 1.1 V. This voltage, about 0.6 V, is still higher than the level at which the comparator on  $C_{CB}$  detects if the CB pin is shorted to ground.

The boost time consists of 63 saw-toothed pulses at the CB pin and automatically followed by the transition time at the CP pin. The 32 saw-tooth pulses form the transition time from boost to burn enabling a smooth transition between the current controlled boost and burn state. The total transition time is approximately four times the preheat time as shown in Figure 6.



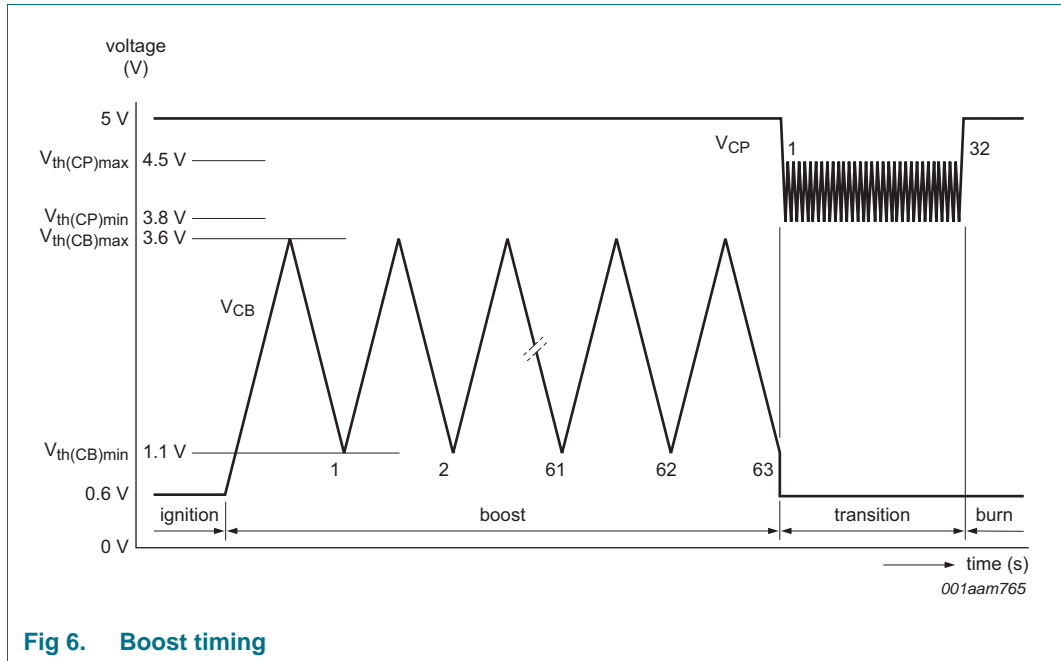

Fig 6. Boost timing

In the boost state, the lamp current feedback control circuit operates the same as in the burn state. This action is used to improve lamp stability. Lamp current boosted by a fixed ratio of 1.5 compared to the burn state, boosts up the slow luminescence increase of a cold CFL lamp. In the boost to burn transition time there is a slow 15-step ratio decrease from 1.5 to 1. For the transition to burn time, the preheat timer is reused and the boost ratio is gradually decreased in 15 steps from 1.5 to 1. The steps occur within 32 saw-toothed pulses on the CP pin. The 32 saw-toothed pulses form the transition time from boost to burn to enable a smooth transition between the current controlled boost and burn state. Given the application values of  $C_{CB}$  and  $R_{ext(RREF)}$  a boost time of more than 300 s is possible. In addition to boost bypass at temperature  $T_{j(bp)bst} (\approx 80\text{ }^{\circ}\text{C})$ , there is a temperature protection function during the boost state of  $T_{j(end)bst} (\approx 120\text{ }^{\circ}\text{C})$ . If the IC temperature passes this level during boost, the transition timer is immediately started in order to enter the burn state faster. This action effectively reduces the boost time. See [Figure 4 \[B\]](#).

The current boost in the boost state does not start when  $V_{i(DCI)}$  is lower than  $V_{th(bst)DCI}$ . Current boost ends when  $V_{i(DCI)}$  is lower than  $V_{th(bst)DCI} - V_{th(bst)hys(DCI)}$  without a boost transition. See [Figure 4 \[A\]](#).

**Remark:** If the CB pin is shorted to ground, the boost function is disabled. During such conditions, the bottom frequency  $f_{bridge(min)}$  is 1.8 times higher than the boost bottom frequency  $f_{bridge(bst)min}$ .

### 7.1.6 Burn state

After the boost state, or when the boost state is bypassed burn state starts. The lamp current sensor circuit is still enabled. See [Figure 4 \[A\]](#). The CSI pin (current sense input) measures the RMS voltage across sense resistor  $R_{CS1}$ . It then passes through a Double-Sided Rectifier (DSR) circuit and fed towards an Operational Transconductor Amplifier (OTA). When the RMS voltage on the CSI pin reaches the internal reference level, the lamp current sensor circuit takes over the control of the lamp current. The

internal current output of the OTA is transferred via an integrator on the CI pin to the input of the Voltage Controlled Oscillator (VCO). The VCO regulates the frequency and as a result, the lamp current.

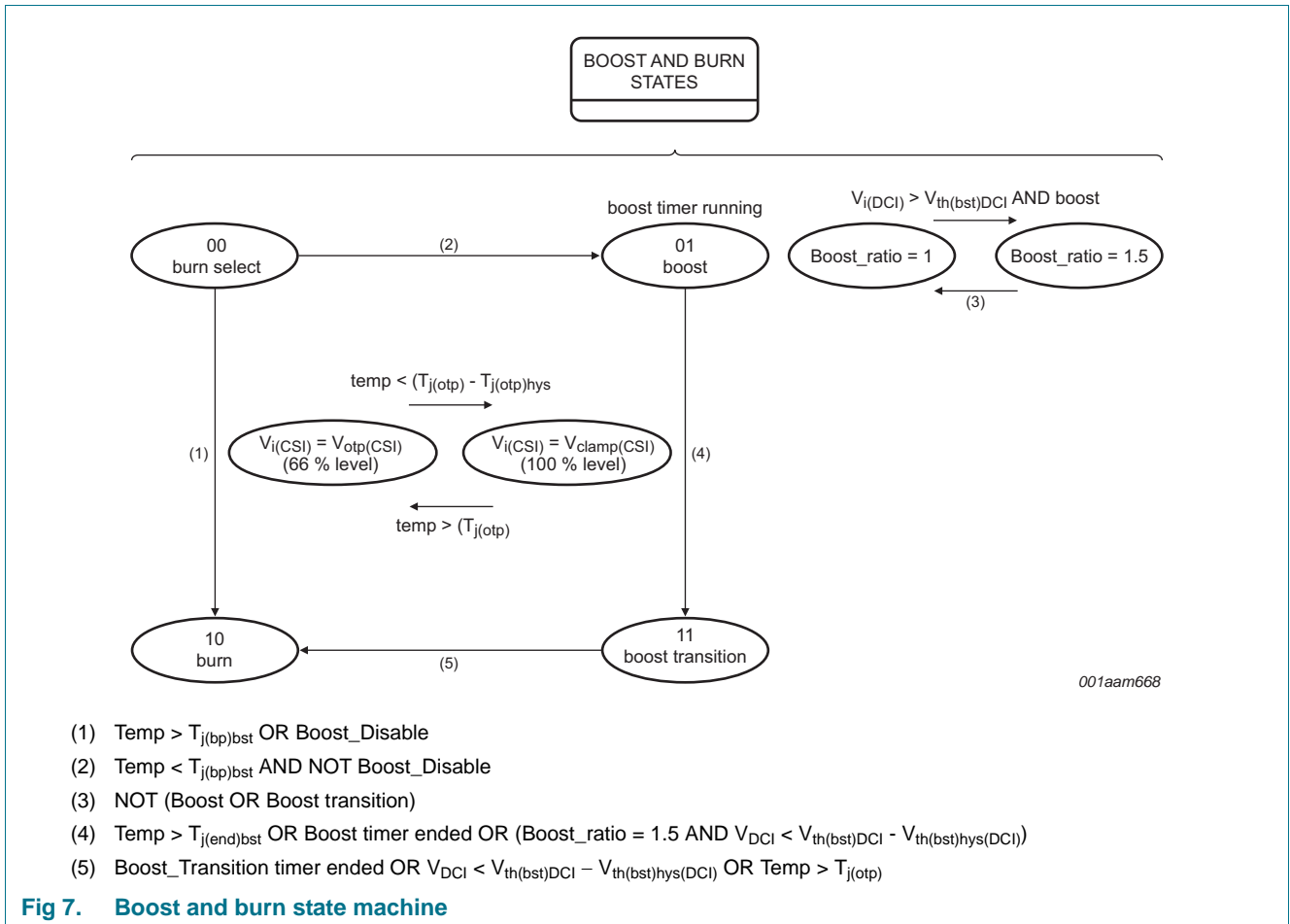

Fig 7. Boost and burn state machine

### 7.1.7 Hold state

The hold state is a special state to reduce lamp flicker at deep dim levels, on or near dim and ignition threshold level. See [Figure 3](#).

The hold state is entered following:

- a failed ignition attempt
- or when the low supply voltage  $V_{DD}$  is lower than  $V_{DD(stop)}$  in the ignition or preheat state
- or when  $V_{DCI} < V_{th(start)DCI} - V_{th(hys)DCI}$  in the ignition or preheat state

A repeated aborted preheat or ignition cycle due to a drop in DCI voltage that is lower than  $V_{th(start)DCI} - V_{th(hys)DCI}$  or a drop in supply voltage that is lower than  $V_{DD(stop)}$  in preheat or ignition state does not increment the ignition attempt counter. The UBA20271/2 enters the hold state only delaying a new preheat cycle by the same time delay and mechanism. As shown in [Figure 5](#) hold state retention time.

When CP is lower than  $V_{th(re)CP}$ , the IC is released from the hold state and moves to the start-up state. See [Figure 3](#). Alternatively, the hold state ends when the supply voltage is lower than  $V_{DD(rst)}$  and the IC is reset.

With a 470 nF capacitor on the CP pin, the typical hold state retention delay is between 1.0 seconds and 1.7 seconds. However, it depends on where the preheat cycle is cut off on the rising or falling edge of the preheat timing. The retention time for a failed ignition always starts from the top of the rising edge on the CP pin. See [Figure 5](#). In the hold state, a latch is set (hold state latch = 1), the oscillator is stopped, transistor HS is non-conductive and transistor LS conducting. The voltage on pin  $V_{DD}$  alternates between  $V_{DD(start)}$  and  $V_{DD(stop)}$  as long as the voltage on the CP pin has not reached  $V_{th(re)CP}$ . See [Figure 5](#).

The alternating supply voltage is a result of the current drawn by the IC supply pin  $V_{DD}$ . The supply current is less than 220  $\mu$ A, when the supply voltage  $V_{DD}$  is increasing between  $V_{DD(stop)}$  and  $V_{DD(start)}$ . The supply current is typically 2 mA when  $V_{DD}$  is decreasing between  $V_{DD(start)}$  and  $V_{DD(stop)}$ . More current is drawn during the decreasing slope of  $V_{DD}$  as the internal analog supply is turned on when  $V_{DD} > V_{DD(start)}$ . This condition enables comparators in the IC to monitor the voltage on the CP pin and whether the supply voltage  $V_{DD}$  decreases lower than  $V_{DD(stop)}$ .

## 7.2 Oscillation and timing

### 7.2.1 Oscillation

The internal oscillator is a VCO circuit which generates a sawtooth waveform between the  $V_{th(CF)max}$  level and 0 V. Capacitor  $C_{CF}$ , resistor  $R_{ext(RREF)}$ , and the voltage at the CI pin determine the frequency of the sawtooth.  $R_{ext(RREF)}$  and  $C_{CF}$  determine the minimum and maximum switching frequencies. Their ratio is internally fixed. There are two ratios, the ratio between  $f_{bridge(max)}$  and  $f_{bridge(min)}$  is 2.5 and the ratio between  $f_{bridge(max)}$  and  $f_{bridge(bst)min}$  is 4.6. The sawtooth frequency is twice the half-bridge frequency.

Transistors HS (Q1) and LS (Q2) are brought into conduction with a duty cycle of approximately 50 %. [Figure 8](#) provides an overview of the oscillator signal and driver signals. The oscillator starts oscillating at  $f_{bridge(max)}$ . The non-overlap time between the gate drive signals  $V_{GLS}$  and  $V_{GHS}$  is  $t_{no}$ .

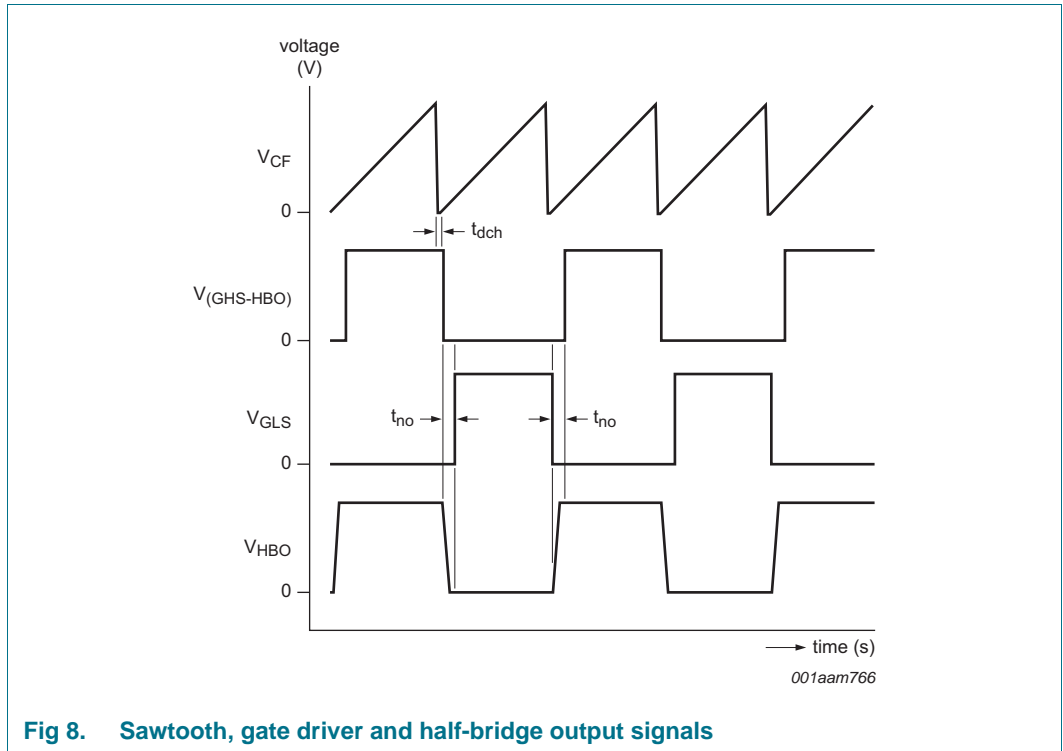

Fig 8. Sawtooth, gate driver and half-bridge output signals

### 7.2.2 Combined timing circuit

A combined timing circuit is included to determine the preheat time, ignition enabling time and overcurrent time, see [Figure 9](#). The circuit consists of a clock generator defined by  $C_{CP}$  and  $R_{ext(RREF)}$  and a counter. When the timer is not operating,  $C_{CP}$  is charged to 5 V. The timing circuit starts operating following the start-up state, as soon as the low supply voltage has reached  $V_{DD(start)}$ . Additionally the DCI input voltage is higher than  $V_{th(start)DCI}$  and the voltage on pin CP must pass  $V_{th(CP)max}$ . The preheat time consists of eight saw-tooth pulses on the CP pin as shown in [Figure 9](#). The maximum ignition enabling time following the preheat phase is two complete sawtooth (triangular) pulses. During the boost and burn state, part of the timer is used to generate the maximum overcurrent time (more than one half of the saw-toothed pulse). If a continuous overcurrent is detected, the timer starts.

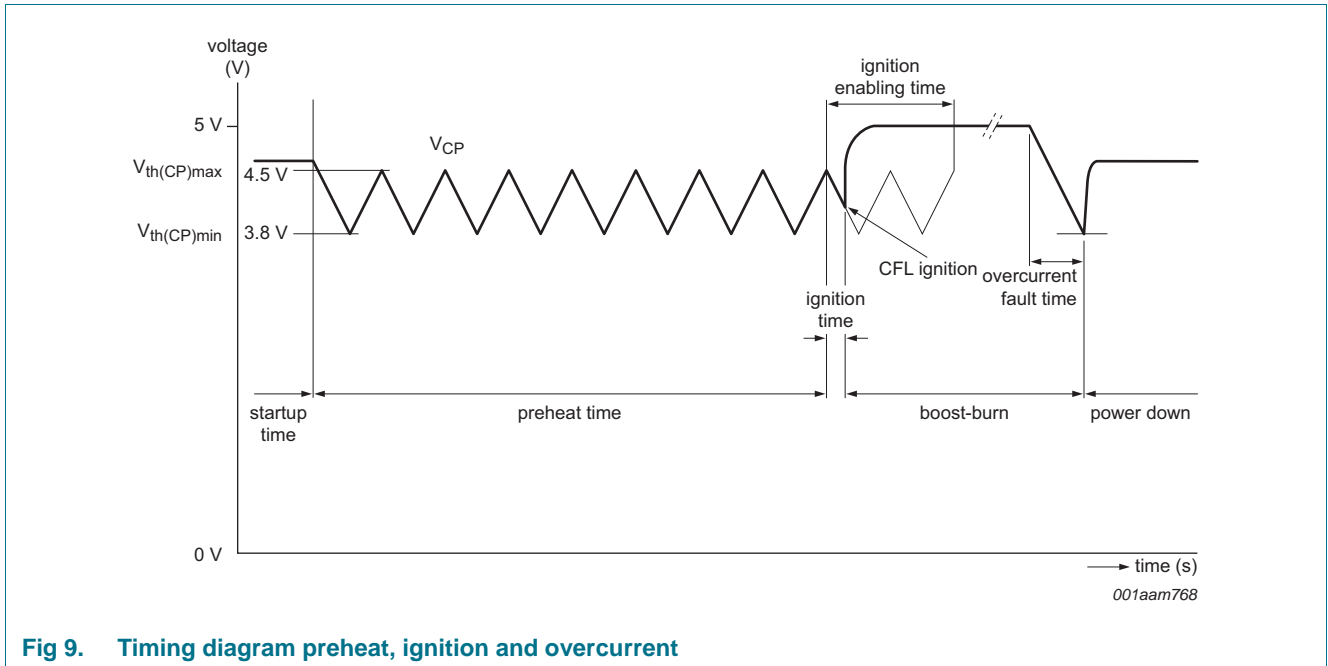

Fig 9. Timing diagram preheat, ignition and overcurrent

### 7.3 Natural linear dimming

What determines the actual internal set point level used for the current control feedback loop is an external level applied via the DCI pin for dimming. The DCI voltage is a function of the phase cut angle of the applied dimmer. To ensure that the external input for the control on the DCI pin internally stays within a certain range, this input signal passes an internal linear to logarithmic conversion circuit followed by a limiting circuit.

The linear to logarithmic conversion circuit is designed to improve dimming control by correcting for the higher sensitivity of the human eye to small changes in low light levels. See [Figure 10](#). The conversion circuit also provides a natural perceived linear brightness adjustment of the lamp.

The limiting circuit prevents the signal falling below the MDL or rising above the 100 % reference level of  $V_{clamp(CSI)}$ . The output of the linear to logarithmic conversion circuit is the actual reference voltage for the lamp current control loop. See signal  $V_{LD}$  in [Figure 1](#) (dimmer control block). When the IC is in the burn state, the voltage is equal to the RMS voltage on the CSI pin. When the control loop is regulating correctly, the upper limit is clamped at the 100 % reference level. This condition prevents lamp current values that are too high in mains overvoltage situations. See [Figure 10](#).

The MDL level presets a minimum to which the lamp current clips at low dim levels and is adjustable via the MDL pin. An accurate minimum dimming voltage level is set by using an internal reference current (derived from the internal band gap reference circuit and resistor  $R_{ext(RREF)}$ ) and an applied external resistor  $R_{MDL}$  on the MDL pin.

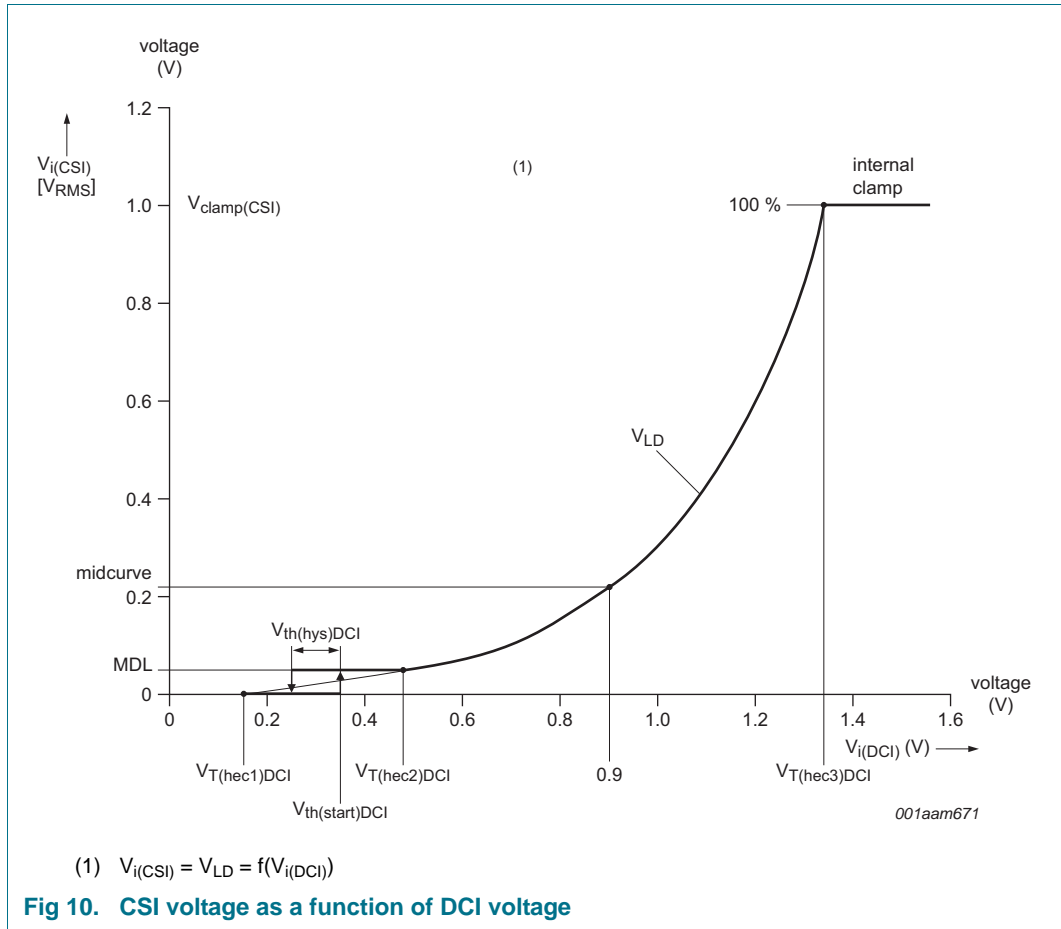

## 7.4 Protection and power-down

### 7.4.1 Coil saturation protection

Coil saturation protection is integrated into the IC to allow for the use of small CFL lamps and use of small coils. Saturation of these coils is detected and excessive overcurrent due to saturation is prevented. Coil saturation protection is only enabled during the ignition state. To limit voltages and currents in the resonant circuit when there is no ignition or delayed ignition, a cycle-by-cycle control mechanism is used to prevent coil saturation. This control also limits the high peak current and dissipation in the half-bridge power transistors.

Coil saturation is detected by monitoring the voltage across the  $R_{SLS}$  resistor. A trigger is generated when this voltage exceeds the  $V_{th(sat)SLS}$  level. When saturation is detected, a fixed current  $\Delta I_{O(sat)CF}$  is injected into the  $C_{CF}$  capacitor to shorten the switching cycle of the half-bridge. The injected current is maintained until the end of the switching cycle. This action immediately increases the half-bridge switching frequency. Furthermore, in each successive cycle that coil saturation is detected, capacitor  $C_{CI}$  is discharged to enable an ignition time-out detection in the ignition state.

Coil saturation protection is triggered when the voltage on the SLS pin exceeds  $V_{th(sat)SLS}$ . The voltage  $V_{SLS}$  on the SLS pin is also used to set the preheat current. The value of external resistor  $R_{SLS}$  determines this voltage. With an internal reference source current

and external resistor  $R_{LSAT}$  connected to the LSAT pin, a more secure setting of the threshold level  $V_{th(sat)SLS}$  is possible. When resistor  $R_{LSAT}$  is not mounted, the  $V_{th(sat)SLS}$  level is internally clamped at 2.5 V.  $C_{LSAT}$  parallel to  $R_{LSAT}$  is obligatory for stability reasons even when  $R_{LSAT}$  is not mounted.

#### 7.4.2 OverCurrent Protection (OCP)

OCP is active in the burn and boost states (not during boost transition). When the peak absolute value of the voltage across the current sense resistor on the SLS pin exceeds the OCP reference level  $V_{th(ocp)SLS}$ , overcurrent is detected. A current  $I_{o(CP)}$  is then sunk from the capacitor connected to the CP pin for the next full cycle. If the overcurrent is absent at the end of this cycle, this current is disabled. Instead a current, equal to  $I_{o(CP)}$ , is sourced to CP. If the overcurrent occurs in more than half the number of cycles, there is a net discharging of the capacitor connected to the CP pin. When the voltage, on the CP pin drops lower than  $V_{th(CP)min}$ , the IC enters power-down mode. In a continuous overcurrent condition, the overcurrent time-out of  $t_{fault(oc)}$  takes about  $1/10 t_{ph}$ . The IC then enters the power-down mode. The  $V_{th(ocp)SLS}$  level corresponds with the  $V_{th(sat)SLS}$  level during the ignition state.

#### 7.4.3 OverPower Protection (OPP)

OPP is active in boost and burn state. The lamp current is limited and regulated to its nominal designed lamp current in case overvoltage situations on the mains supply occur. Overpower begins when the DCI voltage, that regulates the lamp current is exceeding the maximum DCI input range. Internally the DCI voltage is clamped to the maximum input voltage level  $V_{T(hec3)DCI}$  see [Figure 10](#). The DCI clamp level is independent of any supply voltage fluctuations.

#### 7.4.4 Capacitive Mode Protection (CMP)

CMP is active in the ignition, burn and boost states and during boost transition. The signal across resistor  $R_{SLS}$  also provides information about the switching behavior of the half-bridge. When conditions are normal, the current flows from the source of the LS transistor to the half-bridge when the LS transistor is switched on. This results in a negative voltage on the SLS pin. As the circuit yields to capacitive mode, the voltage decreases and eventually reverses polarity. The protection prevents this condition from happening by checking if the voltage on the SLS pin is higher than  $V_{th(capm)SLS}$ .

If the voltage across resistor  $R_{SLS}$  is higher than the  $V_{th(capm)SLS}$  threshold when the LS transistor is switched on, the circuit assumes that it is in capacitive mode. When capacitive mode is detected, the currents from the OTA are disabled and the capacitive mode sink current,  $I_{o(sink)CI}$ , is enabled. This sink current discharges the capacitor/resistor circuitry on the CI pin and as a result gradually increase the half-bridge frequency. Discharge continues for the remainder of the current switching cycle, so the total current on CI is equal to the sink current. If capacitive mode persists, the action is repeated until capacitive mode is not detected. If capacitive mode is no longer detected, the OTA starts regulating again.

If the conditions causing the capacitive mode persist, the OTA regulates the system back towards capacitive mode with the protection system taking control. The system operates on the edge of capacitive mode. During boost and burn state, if the load on the half-bridge continues to be capacitive at higher frequencies, CMP then eventually drives the half-bridge to the maximum frequency  $f_{bridge(max)}$ . From this point, the IC enters power-down mode.

#### 7.4.5 Power-down mode

Power-down mode starts when:

- a continuous overcurrent exceeds the maximum overcurrent time-out  $t_{\text{fault(oc)}}$ . Or over a longer period when an overcurrent occurs in more than half the number of cycles  $V_{\text{th(CP)min}}$  is reached.
- during the boost or the burn state  $f_{\text{bridge(max)}}$  is reached due to capacitive mode detection
- two consecutive failed lamp ignition attempts occur

In power-down mode, the oscillator is stopped and the HS transistor is non-conductive while the LS transistor is conductive. The  $V_{\text{DD}}$  supply is internally clamped. The circuit is released from power-down mode by lowering the low voltage supply lower than  $V_{\text{DD(rst)}}$  (mains switch reset).

An option exists to set the IC in power-down mode via external logic. The external power-down option is only available when the IC is in the boost or burn state. To enable the external power-down option, the CP pin is used. When pin CP, is connected via a 10 k $\Omega$  resistor to either the PGND or SGND the voltage on pin CP is pulled down lower than  $V_{\text{th(pd)CP}}$ . This results in the IC entering power-down mode.

**Remark:** Do not connect the CP pin directly to the SGND or PGND pin. Connect the SGND or PGND pin via a series 10 k $\Omega$  resistor otherwise excessive currents flow during reset and start-up. Excessive current prevent the IC from starting up.

#### 7.4.6 OverTemperature Protection (OTP)

The OTP circuit is designed to prevent the IC from overheating in hazardous environments. The circuit is triggered when the IC temperature exceeds the maximum temperature value  $T_{\text{j(otp)}}$ . OTP changes the lamp current to the level that corresponds to  $V_{\text{otp(CSI)}}$  level. This condition remains until the IC temperature reduces by 20 °C ( $=T_{\text{j(otp)hys}}$ ) and returns to the DCI controlled level.



## 8. Limiting values

**Table 3. Limiting values**

In accordance with the Absolute Maximum Rating System (IEC 60134).

Symbol	Parameter	Conditions	Min	Max	Unit
<b>General</b>					
$R_{ext(RREF)}$	external resistance on pin RREF	fixed nominal value 33 k $\Omega$	30	36	k $\Omega$
SR	slew rate	on pins HBO with respect to GND	-4	+4	V/ns
$T_{amb}$	ambient temperature	P = 0.8 W	-40	85	$^{\circ}$ C
$T_j$	junction temperature		-40	+150	$^{\circ}$ C
$T_{stg}$	storage temperature		-55	+150	$^{\circ}$ C
<b>Currents</b>					
$I_{DM}$	peak drain current	UBA20272: $T_j < T_{jmax}$ ; high-side; $I_{DM} = I_{DHS} = I_{HBO}$	-	2.7	A
		low-side; $I_{DM} = I_{HBO} = I_{o(SLS)}$	-	2.7	A
	peak drain current	UBA20271: $T_j < T_{jmax}$ ; high-side; $I_{DM} = I_{DHS} = I_{HBO}$	-	5.0	A
		low-side; $I_{DM} = I_{HBO} = I_{o(SLS)}$	-	5.0	A
$I_D$	off-state current	UBA20272: $T_j = T_{jmax}$ ; high-side; P = 0.5 W; $I_D = I_{DHS} = I_{HBO}$	-	0.31	A
		low-side; $I_D = I_{HBO} = I_{o(SLS)}$	-	0.31	A
	off-state current	UBA20271: $T_j = T_{jmax}$ ; P = 0.5 W; high-side; $I_D = I_{DHS} = I_{HBO}$	-	0.54	A
		low-side; $I_D = I_{HBO} = I_{o(SLS)}$	-	0.54	A
$I_{i(CF)}$	input current on pin CF		0	200	$\mu$ A
<b>Voltages</b>					
$V_{DHS}$	voltage on pin DHS	UBA20272: operating during 1 second	-	500	V
			-	600	V
	voltage on pin DHS	UBA20271: operating at $T_{amb} = 25^{\circ}$ C	-	350	V
		operating at $T_{amb} = -25^{\circ}$ C	-	340	V
$V_{FS}$	voltage on pin FS	with respect to HBO	-0.3	+14	V
$V_{DD}$	supply voltage		-0.3	+14	V
$V_{i(CSI)}$	input voltage on pin CSI		-5	+5	V
$V_{i(DCI)}$	input voltage on pin DCI		0	5	V
$V_{i(SLS)}$	input voltage on pin SLS		-6	+6	V

**Table 3. Limiting values ...continued**  
In accordance with the Absolute Maximum Rating System (IEC 60134).

Symbol	Parameter	Conditions	Min	Max	Unit
$V_{CI}$	voltage on pin CI		0	3.5	V
$V_{MDL}$	voltage on pin MDL		0	5	V
<b>ESD</b>					
$V_{ESD}$	electrostatic discharge voltage	human body model:			
		all pins, except pins 16, 17, 18, 19 and 20	-2000	+2000	V
		pins 16, 17, 18, 19 and 20	-1000	+1000	V
		charged device model:			
		all pins	-400	+400	V
<b>Latch-up</b>			[1]	-	-

[1] In accordance with SNW-FQ-303: all pins.

## 9. Thermal characteristics

**Table 4. Thermal characteristics**

Symbol	Parameter	Conditions	Typ	Unit
$R_{th(j-a)}$	thermal resistance from junction to ambient	in free air; SO20 package on JEDEC 2S 2P board	56	K/W

## 10. Characteristics

**Table 5. Characteristics**

$V_{DD} = 13\text{ V}$ ;  $V_{FS} - V_{HBO} = 13\text{ V}$ ;  $T_{amb} = 25\text{ °C}$ ; settings according to default setting in [Table 6](#), all voltages referenced to GND, positive currents flow into the IC, unless otherwise specified.

Symbol	Parameter	Conditions	Min	Typ	Max	Unit	
Start-up state (VDD)							
$V_{DD(rst)}$	reset supply voltage	high-side switch = off; low-side switch = on	5.7	6.2	6.7	V	
$V_{DD(stop)}$	stop supply voltage		9.6	10.0	10.4	V	
$V_{DD(start)}$	start supply voltage		11.9	12.4	12.9	V	
$V_{DD(hys)}$	hysteresis of supply voltage		2.2	2.4	2.6	V	
$V_{DD(clamp)}$	clamp supply voltage	$I_{clamp(VDD)} = 5\text{ mA}$	13.0	13.4	13.8	V	
$I_{DD(clamp)}$	clamp supply current	$V_{DD} = 14\text{ V}$	20	30	-	mA	
$I_{DD(startup)}$	start-up supply current	$V_{DD} = 9\text{ V}$	-	190	220	μA	
$I_{DD(pd)}$	power-down supply current	$V_{DD} = 9\text{ V}$	-	190	220	μA	
$I_{DD}$	supply current	default setting; $V_{DCI} = 1.4\text{ V}$ $V_{CI} = V_{clamp(CI)}$ , $V_{CB} = 0\text{ V}$	[1]	-	1.6	2.0	mA

**Table 5. Characteristics ...continued**

$V_{DD} = 13\text{ V}$ ;  $V_{FS} - V_{HBO} = 13\text{ V}$ ;  $T_{amb} = 25\text{ °C}$ ; settings according to default setting in [Table 6](#), all voltages referenced to GND, positive currents flow into the IC, unless otherwise specified.

Symbol	Parameter	Conditions	Min	Typ	Max	Unit
<b>High-voltage supply (DHS, HBO and FS)</b>						
$I_{leak}$	leakage current	UBA20271; 300 V on high-voltage pins	-	-	30	$\mu\text{A}$
		UBA20272; 500 V on high-voltage pins	-	-	30	$\mu\text{A}$
<b>Voltage controlled oscillator</b>						
Output pin IC						
$V_{Cl(max)}$	maximum voltage on pin CI		2.7	3.0	3.3	V
$V_{hr(CI)}$	headroom voltage on pin CI	$V_{clamp(CI)} = V_{hr(CI)} + V_{Cl(max)}$ ; burn and boost state	-	80	-	mV
<b>Voltage controlled oscillator</b>						
Output pin CF						
$f_{bridge(max)}$	maximum bridge frequency	$C_{CF} = 100\text{ pF}$ ; $V_{CI} = 0\text{ V}$	<a href="#">[2]</a> 88	100	112	kHz
$f_{bridge(bst)min}$	minimum boost bridge frequency	$C_{CF} = 100\text{ pF}$ ; $V_{CI} = V_{clamp(CI)}$	<a href="#">[2]</a> 21	22	23	kHz
$f_{bridge(min)}$	minimum bridge frequency	$C_{CF} = 100\text{ pF}$ ; $V_{CI} = V_{clamp(CI)}$ ; $V_{CB} = 0\text{ V}$	<a href="#">[2]</a> 38	40	42	kHz
$t_{no}$	non-overlap time	$V_{HBO}$ rising edge	1.3	1.5	1.7	$\mu\text{s}$
		$V_{HBO}$ falling edge	1.3	1.5	1.7	$\mu\text{s}$
$V_{th(CF)max}$	maximum threshold voltage on pin CF	$C_{CF} = 100\text{ pF}$ ; $V_{CI} = V_{clamp(CI)}$ ; $V_{CB} = 0\text{ V}$	2.40	2.50	2.60	V
$I_{o(bst)CF}$	boost output current on pin CF	$V_{CF} = 1.5\text{ V}$ ; $V_{CI} = V_{clamp(CI)}$	-12.3	-11.8	-11.3	$\mu\text{A}$
$I_{o(CF)min}$	minimum output current on pin CF	$V_{CF} = 1.5\text{ V}$ ; $V_{CB} = 0\text{ V}$ ; $V_{CI} = V_{clamp(CI)}$	-22.8	-21.8	-20.8	$\mu\text{A}$
$I_{o(CF)max}$	maximum output current on pin CF	$V_{CF} = 1.5\text{ V}$ ; $V_{CB} = 0\text{ V}$	-67.0	-60.0	-53.0	$\mu\text{A}$
<b>Power transistors</b>						
$R_{on}$	on-state resistance	UBA20272: high-side $I_{DHS} = 1.1\text{ A}$ ; $T_j = 25\text{ °C}$	-	3.0	3.6	$\Omega$
	on-state resistance	UBA20271: high-side $I_{DHS} = 1.1\text{ A}$ ; $T_j = 25\text{ °C}$	-	1.0	1.3	$\Omega$
$R_{on}$	on-state resistance	UBA20272: low-side $I_{HBO} = 1.1\text{ A}$ ; $T_j = 25\text{ °C}$	-	3.0	3.6	$\Omega$
	on-state resistance	UBA20271: low-side $I_{HBO} = 1.1\text{ A}$ ; $T_j = 25\text{ °C}$	-	1.0	1.3	W

**Table 5. Characteristics ...continued**

$V_{DD} = 13\text{ V}$ ;  $V_{FS} - V_{HBO} = 13\text{ V}$ ;  $T_{amb} = 25\text{ °C}$ ; settings according to default setting in [Table 6](#), all voltages referenced to GND, positive currents flow into the IC, unless otherwise specified.

Symbol	Parameter	Conditions	Min	Typ	Max	Unit
$R_{on(150)}/R_{on(25)}$	on-state resistance ratio (150 °C to 25 °C)	$R_{ON}$ at $T_j = 150\text{ °C}$ / $R_{ON}$ at $T_j = 25\text{ °C}$	-	1.7	-	
<b>Bootstrap diode</b>						
$V_F$	forward voltage	bootstrap diode; $I_{FS} = 5\text{ mA}$ ; ( $V_F = V_{DD} - V_{FS}$ )	1.3	1.7	2.1	V
<b>Preheat current sensor</b>						
<b>Input: pin SLS</b>						
$I_{i(SLS)}$	input current on pin SLS	$V_{i(SLS)} = 0.4\text{ V}$	-	-	1	$\mu\text{A}$
$V_{ph(SLS)}$	preheat voltage on pin SLS		[3] 0.57	0.60	0.63	V
<b>Output: pin CI</b>						
$I_{o(source)CI}$	source output current on pin CI	$V_{CI} = 2.0\text{ V}$ ; $V_{i(SLS)} < 0.6\text{ V}$	-10.6	-9.6	-8.6	$\mu\text{A}$
$I_{o(sink)CI}$	sink output current on pin CI	$V_{CI} = 2.0\text{ V}$ ; $V_{i(SLS)} > 0.6\text{ V}$	26	29	32	$\mu\text{A}$
<b>Preheat timer, ignition timer, overcurrent fault timer</b>						
<b>Pin CP</b>						
$t_{ph}$	preheat time	$C_{CP} = 470\text{ nF}$ ; $R_{ext(RREF)} = 33\text{ k}\Omega$	-	0.93	-	s
$t_{en(ign)}$	ignition enable time	$C_{CP} = 470\text{ nF}$ ; $R_{ext(RREF)} = 33\text{ k}\Omega$	-	0.22	-	s
$t_{fault(oc)}$	overcurrent fault time	$C_{CP} = 470\text{ nF}$ ; $R_{ext(RREF)} = 33\text{ k}\Omega$ ; initial voltage $V_{CP} = 5.0\text{ V}$	-	0.10	-	s
$I_{o(CP)}$	output current on pin CP	$V_{CP} = 4.1\text{ V}$ ; source (-) and sink (+)	5.5	5.9	6.3	$\mu\text{A}$
$V_{th(CP)min}$	minimum threshold voltage on pin CP		-	3.8	-	V
$V_{th(CP)max}$	maximum threshold voltage on pin CP		-	4.5	-	V
$V_{hys(CP)}$	hysteresis voltage on pin CP		0.6	0.7	0.8	V
$I_{pu(CP)}$	pull-up current on pin CP	$V_{CP} = 3.8\text{ V}$	-	-60	-	$\mu\text{A}$
$V_{th(pd)CP}$	power-down threshold voltage on pin CP	burn state, pin CP connected to SGND via 10 k $\Omega$	-	1.0	-	V
$V_{th(rel)CP}$	release threshold voltage on pin CP	hold state, $V_{DCI} = 1.4\text{ V}$	-	2.7	-	V
<b>Boost timer</b>						
<b>Pin CB</b>						
$t_{bst}$	boost time	$C_{CB} = 470\text{ nF}$ ; $T_j < 80\text{ °C}$	-	148	-	s
$I_{o(CB)}$	output current on pin CB	$V_{CB} = 2.35\text{ V}$ ; source (-) and sink (+)	0.8	1.0	1.2	$\mu\text{A}$

**Table 5. Characteristics ...continued**

$V_{DD} = 13\text{ V}$ ;  $V_{FS} - V_{HBO} = 13\text{ V}$ ;  $T_{amb} = 25\text{ °C}$ ; settings according to default setting in [Table 6](#), all voltages referenced to GND, positive currents flow into the IC, unless otherwise specified.

Symbol	Parameter	Conditions	Min	Typ	Max	Unit
$V_{th(CB)min}$	minimum threshold voltage on pin CB		-	1.1	-	V
$V_{th(CB)max}$	maximum threshold voltage on pin CB		-	3.6	-	V
$V_{hys(CB)}$	hysteresis voltage on pin CB		2.3	2.5	2.7	V
$T_{j(bp)bst}$	boost bypass junction temperature	$T_j$ sensed at end ignition time	65	80	95	°C
$T_{j(end)bst}$	boost end junction temperature	$T_j$ during boost time	105	120	135	°C
$I_{det(dis)bst}$	boost disable detection current	$V_{CB} = 0\text{ V}$	-30	-25	-20	μA
$t_{t(bst-burn)}$	transition time from boost to burn	$C_{CP} = 470\text{ nF}$ ; $T_j < 80\text{ °C}$	-	3.6	-	s
<b>Pin CSI</b>						
$N_{LCBR}$	lamp current boost ratio	$V_{CSI}$ in boost state versus $V_{CSI}$ in burn state; $V_{DCI} = 1.34\text{ V}$	1.4	1.5	1.6	
<b>Coil saturation protection and overcurrent detection</b>						
<b>Input: pin SLS</b>						
$V_{th(sat)SLS}$	saturation threshold voltage on pin SLS	ignition state; $R_{LSAT} = 47\text{ k}\Omega$	1.10	1.18	1.25	V
$V_{th(ocp)SLS}$	overcurrent protection threshold voltage on pin SLS	boost state and burn state; $R_{LSAT} = 47\text{ k}\Omega$	1.10	1.18	1.25	V
$t_{leb}$	leading edge blanking time	detection disabled first part of GLS time	-	800	-	ns
$I_{o(sink)CI}$	sink output current on pin CI	$V_{CI} = 2.0\text{ V}$ ; ignition state; $V_{i(SLS)} > V_{th(sat)SLS}$ ; cycle clocked	26	29	32	μA
<b>Input: pin LSAT</b>						
$I_{source( LSAT)}$	source current on pin LSAT	$V_{LSAT} = 1.2\text{ V}$	-26.3	-25.0	-23.7	μA
$V_{clamp( LSAT)}$	clamp voltage on pin LSAT	$R_{LSAT} = \infty$ ;	2.3	2.5	2.7	V
<b>Output: pin CF</b>						
$\Delta I_{o(sat)CF}$	saturation output current difference on pin CF	$V_{CF} = 1.5\text{ V}$ ; ignition state; low side switch = on	-	160	-	μA

**Table 5. Characteristics ...continued**

$V_{DD} = 13\text{ V}$ ;  $V_{FS} - V_{HBO} = 13\text{ V}$ ;  $T_{amb} = 25\text{ °C}$ ; settings according to default setting in [Table 6](#), all voltages referenced to GND, positive currents flow into the IC, unless otherwise specified.

Symbol	Parameter	Conditions	Min	Typ	Max	Unit
<b>Ignition current detection</b>						
Input: pin CSI						
$V_{th(det)ign(CSI)}$	ignition detection threshold voltage on pin CSI		0.55	0.60	0.65	V
$t_{w(det)ign(min)}$	minimum ignition detection pulse width	$V_{th(det)ign(CSI)} = 0.75\text{ V}$ square pulse	685	885	1085	ns
<b>Capacitive mode detection</b>						
Input: pin SLS						
$V_{th(capm)SLS}$	capacitive mode threshold voltage on pin SLS		[4] -15	-5	0	mV
Output: pin CI						
$I_{o(sink)CI}$	sink output current on pin CI	$V_{SLS} > V_{th(capm)SLS}$ ; $V_{CI} = 2.0\text{ V}$ ; ignition state or boost and burn state	26	29	32	$\mu\text{A}$
<b>Lamp current sensor and dimming control</b>						
Input: pin CSI						
$R_{i(CSI)}$	input resistance on pin CSI	$V_{i(CSI)} = 1\text{ V}$	1	-	-	$\text{M}\Omega$
		$V_{i(CSI)} = -1\text{ V}$	40	50	60	$\text{k}\Omega$
$V_{i(CSI)}$	input voltage on pin CSI	controlled feedback RMS voltage at minimum dim level; $V_{i(DCI)} = 0\text{ V}$ ; $R_{ext(RREF)} = 33\text{ k}\Omega$ ; $R_{MDL} = 2.0\text{ k}\Omega$	44	50	56	mV
		controlled feedback RMS voltage at mid scale of $I_{in}$ log curve in burn state; $V_{i(DCI)} = 0.9\text{ V}$ ; $R_{ext(RREF)} = 33\text{ k}\Omega$	-	215	-	mV
		voltage rectification range for linear operation	-2.5	-	+2.5	V
$V_{clamp(CSI)}$	clamping voltage on pin CSI	100 % light output; $V_{i(DCI)} \geq 1.34\text{ V}$	-	1.0	-	V
Input: pin DCI						
$V_{i(DCI)}$	input voltage on pin DCI	minimum voltage set by MDL pin resistor	$V_{T(hec2)DCI}$	-	1.34	V
$R_{i(DCI)}$	input resistance on pin DCI	$V_{i(CSI)} = 1\text{ V}$	1	-	-	$\text{M}\Omega$
$V_{th(bst)DCI}$	boost threshold voltage on pin DCI		1.00	1.05	1.10	V
$V_{th(bst)hys(DCI)}$	hysteresis boost threshold voltage on pin DCI		80	100	120	mV

**Table 5. Characteristics ...continued**

$V_{DD} = 13\text{ V}$ ;  $V_{FS} - V_{HBO} = 13\text{ V}$ ;  $T_{amb} = 25\text{ °C}$ ; settings according to default setting in [Table 6](#), all voltages referenced to GND, positive currents flow into the IC, unless otherwise specified.

Symbol	Parameter	Conditions	Min	Typ	Max	Unit
$V_{th(start)DCI}$	start threshold voltage on pin DCI		-	0.35	-	V
$V_{th(hys)DCI}$	hysteresis threshold voltage on pin DCI		80	100	120	mV
$V_{T(hec1)DCI}$	human eye correction 1 transition voltage on pin DCI	$V_{i(CSI)} = 0\text{ V}$ ; $V_{MDL} = 0\text{ V}$	-	0.17	-	V
$V_{T(hec2)DCI}$	human eye correction 2 transition voltage on pin DCI	$R_{ext(RREF)} = 33\text{ k}\Omega$ ; $R_{MDL} = 2.0\text{ k}\Omega$ ; $V_{i(CSI)} = V_{clamp(CSI)}$	-	0.44	-	V
$V_{T(hec3)DCI}$	human eye correction 3 transition voltage on pin DCI	$V_{i(CSI)} = 1\text{ V}$	-	1.34	-	V
$V_{otp(CSI)}$	overtemperature protection voltage on pin CSI	RMS voltage; $R_{ext(RREF)} = 33\text{ k}\Omega$ ; $R_{MDL} = 2.0\text{ k}\Omega$ ; $V_{i(DCI)} = 1.5\text{ V}$ ; $T_j > T_{j(otp)} - T_{j(otp)hys}$	380	400	420	mV
<b>Output: pin CI</b>						
$I_{o(CI)}$	output current on pin CI	burn state; source (-) and sink (+); $V_{CI} = 2.0\text{ V}$	85	95	105	$\mu\text{A}$
<b>Input: pin MDL</b>						
$I_{source(MDL)}$	source current on pin MDL		-26.3	-25.0	-23.7	$\mu\text{A}$
$V_{MDL}$	voltage on pin MDL	$R_{ext(RREF)} = 33\text{ k}\Omega$ ; $R_{MDL} = 2.0\text{ k}\Omega$	-	50	-	mV
<b>Temperature protection</b>						
$T_{j(otp)}$	overtemperature protection junction temperature		145	160	175	$^{\circ}\text{C}$
$T_{j(otp)hys}$	hysteresis overtemperature protection junction temperature		10	20	30	$^{\circ}\text{C}$

[1] For the default setting, see [Table 6](#).

[2] Switching frequency of the half-bridge output HBO. The sawtooth frequency on pin CF is twice as high.

[3] Data sampling of  $V_{ph(SLS)}$  is performed at the end of the conduction period of the low-side power MOSFET, in preheat state.

[4] Data sampling of  $V_{th(capm)SLS}$  is performed at the start of conduction of the low-side power MOSFET, in all states with oscillator active.

## 11. Application information

### 11.1 Design equations

All equations are only valid for  $R_{ext(RREF)} = 33 \text{ k}\Omega$

#### 11.1.1 $C_{CP}$ related timing equations:

- **Preheat time:**

$$t_{ph} = \frac{C_{CP}}{I_{o(CP)}} \times (16 \times V_{hys(CP)} + 5 - V_{th(CP)max}) \quad (1)$$

- **Ignition enabling time:**

$$t_{en(ign)} = \frac{C_{CP}}{I_{o(CP)}} \times 4 \times V_{hys(CP)} \quad (2)$$

- **Overcurrent fault time:**

$$t_{fault(oc)} = \frac{C_{CP}}{I_{o(CP)}} \times (5 - V_{th(CP)min}) \quad (3)$$

- **Transition to burn time:**

$$t_{t(bst-burn)} = \frac{C_{CP}}{I_{o(CP)}} \times (64 \times V_{hys(CP)} + 5 - V_{th(CP)max}) \quad (4)$$

- **Restart delay time**

$$t_{d(restart)} = \frac{C_{CP}}{I_{restart(CP)}} \times (V_{th(CP)max} - V_{th(rel)CP}) \quad (5)$$

Where:  $I_{restart(CP)} = 0.5 \text{ }\mu\text{A}$  (typical)

#### 11.1.2 $C_{CB}$ related timing equations:

- **Boost time:**

$$t_{bst} = \frac{C_{CB}}{I_{o(CB)}} \times (126 \times V_{hys(CB)} + V_{th(CB)min} - 0.6) \quad (6)$$

#### 11.1.3 $C_{CF}$ related frequency equations:

- **Maximum bridge frequency:**

$$f_{bridge(max)} = \frac{0.5}{\frac{C_{CF} + C_{par}}{I_{o(CF)max}} \times V_{th(CF)max} + t_{dch}} \quad (7)$$

- **Minimum bridge frequency with disabled boost:**



$$f_{bridge(min)} = \frac{0.5}{\frac{C_{CF} + C_{par}}{I_{o(CF)min}} \times V_{th(CF)max} + t_{dch}} \tag{8}$$

- Minimum bridge frequency with enabled boost

$$f_{bridge(bst)min} = \frac{0.5}{\frac{C_{CF} + C_{par}}{I_{o(bst)CF}} \times V_{th(CF)max} + t_{dch}} \tag{9}$$

Where:  $C_{par} = 4.7$  [pF] and  $t_{dch} = 0.4$  [μs] (typical)

11.1.4  $R_{SLS}$  related preheat current:

$$I_{ph(M)} = \frac{V_{ph(SLS)}}{R_{SLS}} \quad I_{ph(RMS)} \approx \frac{V_{ph(SLS)}}{R_{SLS} \times \sqrt{3}} \tag{10}$$

11.1.5  $R_{MDL}$  related MDL:

- MDL threshold voltage:

$$V_{MDL} = R_{MDL} \times I_{source(MDL)} \tag{11}$$

11.1.6  $R_{LSAT}$  related saturation and overcurrent threshold level

- Saturation threshold voltage

$$V_{th(sat)SLS} = V_{th(ocp)SLS} = R_{LSAT} \times I_{source(LSAT)} \tag{12}$$

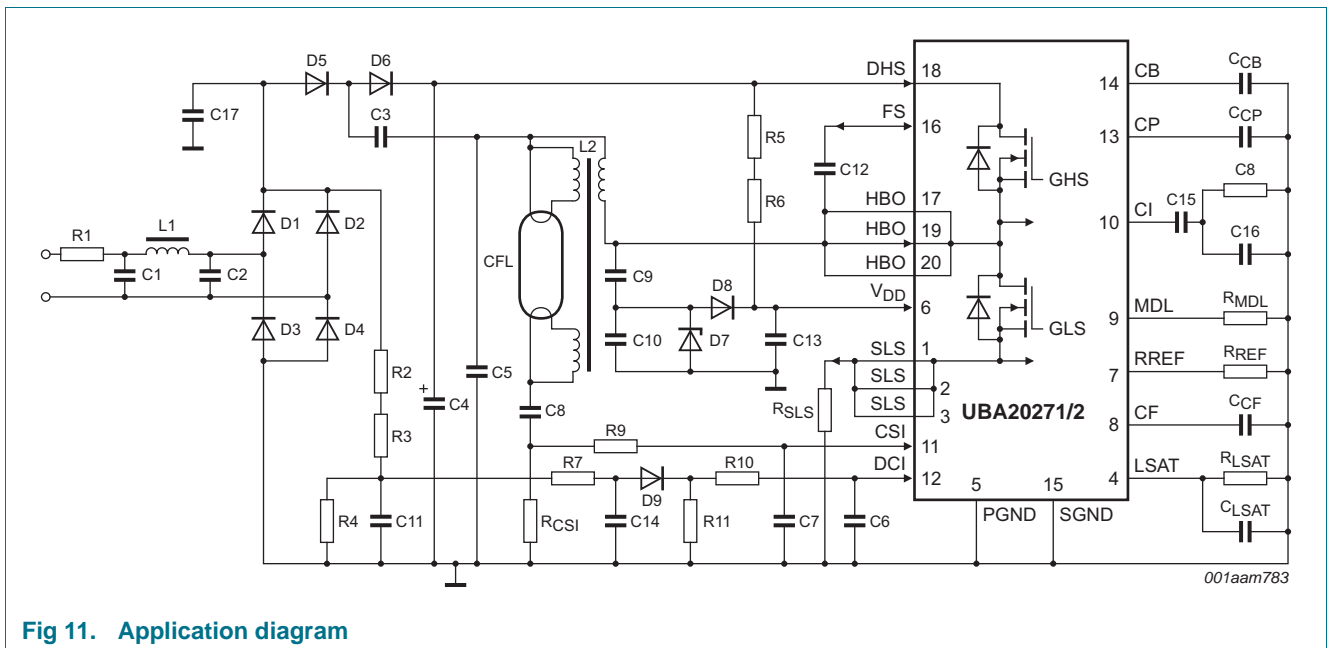

Fig 11. Application diagram

Detailed in [Table 6](#) is a list of typical application components. See [Figure 11](#).

Table 6. Typical components for a 230 V mains application

Reference	Component		Description
	UBA20271	UBA20272	
R1	10 $\Omega$	10 $\Omega$	2 W fusible resistor
R2, R3	110 k $\Omega$	220 k $\Omega$	
R4	22 k $\Omega$	22 k $\Omega$	
R5, R6	110 k $\Omega$	330 k $\Omega$	
R7, R10	100 k $\Omega$	100 k $\Omega$	
R8	560 $\Omega$	1 k $\Omega$	
R9	1 k $\Omega$	1 k $\Omega$	
R11	39 k $\Omega$	39 k $\Omega$	
R <sub>REF</sub>	33 k $\Omega$ ; 1 %	33 k $\Omega$ ; 1 %	
R <sub>SLS</sub>	1 $\Omega$	1.2 $\Omega$	
R <sub>MDL</sub>	1 k $\Omega$	1 k $\Omega$	
R <sub>CSI</sub>	8.2 $\Omega$	8.2 $\Omega$	Adjust for nominal lamp current
R <sub>LSAT</sub>	100 k $\Omega$	100 k $\Omega$	R <sub>LSAT</sub> depends on the LSAT rating of the lamp inductor
C1, C2	22 nF; 400 V	22 nF; 630 V	
C3	3.3 nF; 1000 V	3.3 nF; 1000 V	
C4	22 $\mu$ F; 250 V	10 $\mu$ F; 400 V	
C5	6.8 nF; 1000 V	4.7 nF; 1000 V	lamp capacitor
C6, C14	470 nF	470 nF	
C7	100 pF	100 pF	
C8	22 nF; 400 V	47 nF; 400 V	
C9	560 pF; 500 V	560 pF; 500 V	V <sub>DD</sub> charge pump capacitor
C10	not mounted	not mounted	
C11	4.7 nF	4.7 nF	
C12	100 nF	100 nF	
C13	470 nF	470 nF	
C15	220 nF	220 nF	
C16	not mounted	not mounted	
C17	22 nF; 250 V	22 nF; 400 V	
C <sub>CB</sub>	150 nF	150 nF	
C <sub>CP</sub>	470 nF	470 nF	
C <sub>CF</sub>	100 pF; 2 %	100 pF; 2 %	
C <sub>LSAT</sub>	1 nF	1 nF	
D1 to D4	1N4007	1N4007	
D5, D6	1N4937	1N4937	
D7	BZX84JC12	BZX84JC12	
D8	1N4148	1N4148	

Table 6. Typical components for a 230 V mains application ...continued

Reference	Component		Description
	UBA20271	UBA20272	
L1	4.7 mH	4.7 mH	mains filter inductor; $I_{SAT} = 300 \text{ mA}$
L2	1000/4/4 $\mu\text{H}$	2000/2/2 $\mu\text{H}$	lamp inductor
D9	1N4148	1N4148	

12. Package outline

SO20: plastic small outline package; 20 leads; body width 7.5 mm

SOT163-1

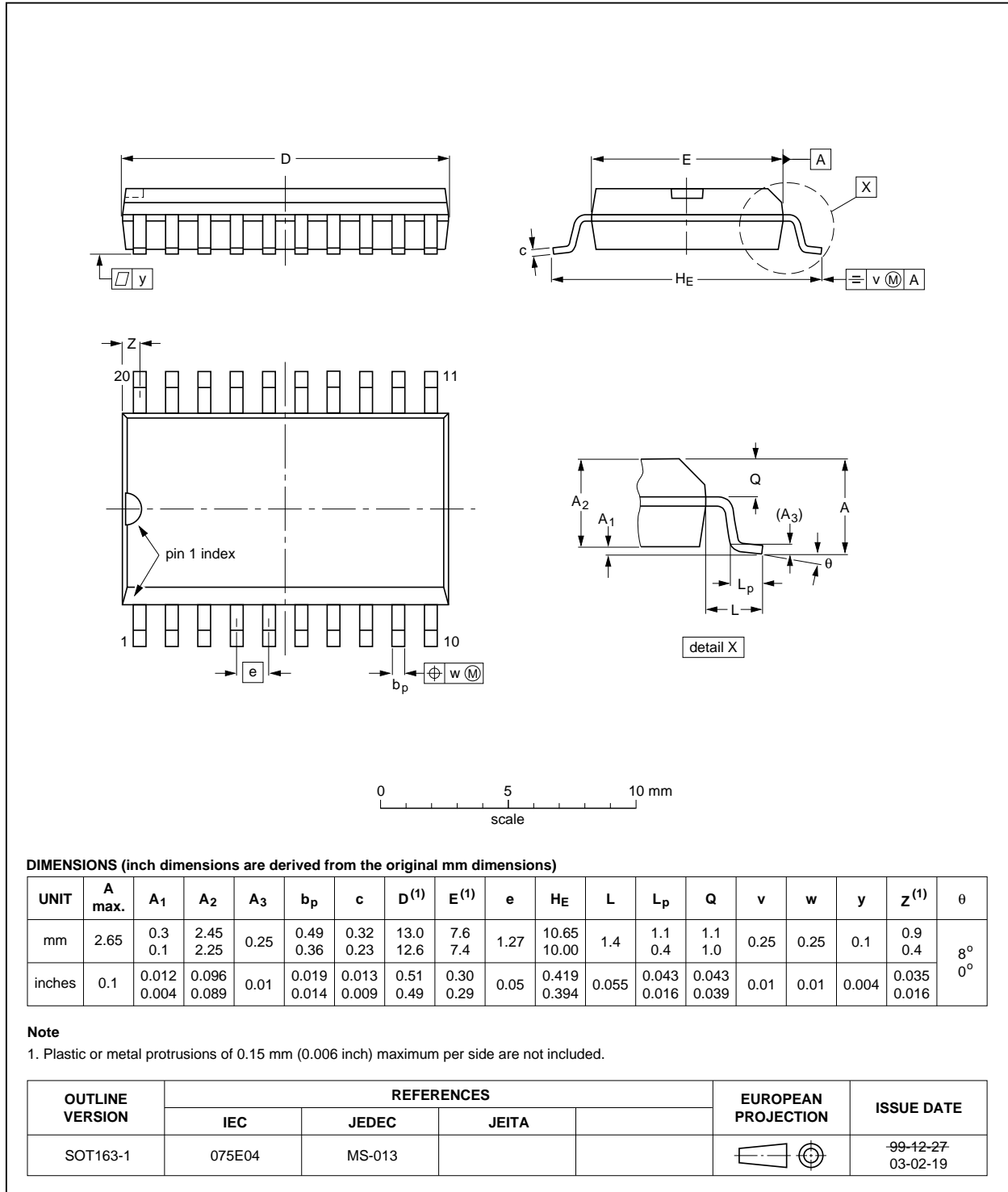

Fig 12. Package outline SOT163-1 (SO20)

## 13. Abbreviations

Table 7. Abbreviations

Acronym	Description
CFL	Compact Fluorescent Lamp
CMP	Capacitive Mode Protection
DSR	Double-Sided Rectifier
ESD	ElectroStatic Discharge
HS	High-Side
LS	Low-Side
MDL	Minimum Dimming Level
OCP	OverCurrent Protection
OPP	OverPower Protection
OTA	Operational Transconductance Amplifier
OTP	OverTemperature Protection
RMS	Root Mean Square
SR	Slew Rate
UVLO	UnderVoltage LockOut
VCO	Voltage Controlled Oscillator

## 14. Revision history

Table 8. Revision history

Document ID	Release date	Data sheet status	Change notice	Supersedes
UBA20271_UBA20272 v.2.1	20111012	Product data sheet	-	UBA20271_UBA20272 v.2
Modifications:	<ul style="list-style-type: none"><li>• minor text changes.</li><li>• <a href="#">Figure 1</a> changed.</li><li>• <a href="#">Figure 2</a> changed.</li></ul>			
UBA20271_UBA20272 v.2	20110816	Product data sheet	-	UBA20271_UBA20272 v.1
UBA20271_UBA20272 v.1	20110816	Preliminary data sheet	-	-

## 15. Legal information

### 15.1 Data sheet status

Document status <sup>[1][2]</sup>	Product status <sup>[3]</sup>	Definition
Objective [short] data sheet	Development	This document contains data from the objective specification for product development.
Preliminary [short] data sheet	Qualification	This document contains data from the preliminary specification.
Product [short] data sheet	Production	This document contains the product specification.

[1] Please consult the most recently issued document before initiating or completing a design.

[2] The term 'short data sheet' is explained in section "Definitions".

[3] The product status of device(s) described in this document may have changed since this document was published and may differ in case of multiple devices. The latest product status information is available on the Internet at URL <http://www.nxp.com>.

### 15.2 Definitions

**Draft** — The document is a draft version only. The content is still under internal review and subject to formal approval, which may result in modifications or additions. NXP Semiconductors does not give any representations or warranties as to the accuracy or completeness of information included herein and shall have no liability for the consequences of use of such information.

**Short data sheet** — A short data sheet is an extract from a full data sheet with the same product type number(s) and title. A short data sheet is intended for quick reference only and should not be relied upon to contain detailed and full information. For detailed and full information see the relevant full data sheet, which is available on request via the local NXP Semiconductors sales office. In case of any inconsistency or conflict with the short data sheet, the full data sheet shall prevail.

**Product specification** — The information and data provided in a Product data sheet shall define the specification of the product as agreed between NXP Semiconductors and its customer, unless NXP Semiconductors and customer have explicitly agreed otherwise in writing. In no event however, shall an agreement be valid in which the NXP Semiconductors product is deemed to offer functions and qualities beyond those described in the Product data sheet.

### 15.3 Disclaimers

**Limited warranty and liability** — Information in this document is believed to be accurate and reliable. However, NXP Semiconductors does not give any representations or warranties, expressed or implied, as to the accuracy or completeness of such information and shall have no liability for the consequences of use of such information.

In no event shall NXP Semiconductors be liable for any indirect, incidental, punitive, special or consequential damages (including - without limitation - lost profits, lost savings, business interruption, costs related to the removal or replacement of any products or rework charges) whether or not such damages are based on tort (including negligence), warranty, breach of contract or any other legal theory.

Notwithstanding any damages that customer might incur for any reason whatsoever, NXP Semiconductors' aggregate and cumulative liability towards customer for the products described herein shall be limited in accordance with the *Terms and conditions of commercial sale* of NXP Semiconductors.

**Right to make changes** — NXP Semiconductors reserves the right to make changes to information published in this document, including without limitation specifications and product descriptions, at any time and without notice. This document supersedes and replaces all information supplied prior to the publication hereof.

**Suitability for use** — NXP Semiconductors products are not designed, authorized or warranted to be suitable for use in life support, life-critical or safety-critical systems or equipment, nor in applications where failure or

malfunction of an NXP Semiconductors product can reasonably be expected to result in personal injury, death or severe property or environmental damage. NXP Semiconductors accepts no liability for inclusion and/or use of NXP Semiconductors products in such equipment or applications and therefore such inclusion and/or use is at the customer's own risk.

**Applications** — Applications that are described herein for any of these products are for illustrative purposes only. NXP Semiconductors makes no representation or warranty that such applications will be suitable for the specified use without further testing or modification.

Customers are responsible for the design and operation of their applications and products using NXP Semiconductors products, and NXP Semiconductors accepts no liability for any assistance with applications or customer product design. It is customer's sole responsibility to determine whether the NXP Semiconductors product is suitable and fit for the customer's applications and products planned, as well as for the planned application and use of customer's third party customer(s). Customers should provide appropriate design and operating safeguards to minimize the risks associated with their applications and products.

NXP Semiconductors does not accept any liability related to any default, damage, costs or problem which is based on any weakness or default in the customer's applications or products, or the application or use by customer's third party customer(s). Customer is responsible for doing all necessary testing for the customer's applications and products using NXP Semiconductors products in order to avoid a default of the applications and the products or of the application or use by customer's third party customer(s). NXP does not accept any liability in this respect.

**Limiting values** — Stress above one or more limiting values (as defined in the Absolute Maximum Ratings System of IEC 60134) will cause permanent damage to the device. Limiting values are stress ratings only and (proper) operation of the device at these or any other conditions above those given in the Recommended operating conditions section (if present) or the Characteristics sections of this document is not warranted. Constant or repeated exposure to limiting values will permanently and irreversibly affect the quality and reliability of the device.

**Terms and conditions of commercial sale** — NXP Semiconductors products are sold subject to the general terms and conditions of commercial sale, as published at <http://www.nxp.com/profile/terms>, unless otherwise agreed in a valid written individual agreement. In case an individual agreement is concluded only the terms and conditions of the respective agreement shall apply. NXP Semiconductors hereby expressly objects to applying the customer's general terms and conditions with regard to the purchase of NXP Semiconductors products by customer.

**No offer to sell or license** — Nothing in this document may be interpreted or construed as an offer to sell products that is open for acceptance or the grant, conveyance or implication of any license under any copyrights, patents or other industrial or intellectual property rights.

**Export control** — This document as well as the item(s) described herein may be subject to export control regulations. Export might require a prior authorization from competent authorities.

**Non-automotive qualified products** — Unless this data sheet expressly states that this specific NXP Semiconductors product is automotive qualified, the product is not suitable for automotive use. It is neither qualified nor tested in accordance with automotive testing or application requirements. NXP Semiconductors accepts no liability for inclusion and/or use of non-automotive qualified products in automotive equipment or applications.

In the event that customer uses the product for design-in and use in automotive applications to automotive specifications and standards, customer (a) shall use the product without NXP Semiconductors' warranty of the product for such automotive applications, use and specifications, and (b) whenever customer uses the product for automotive applications beyond

NXP Semiconductors' specifications such use shall be solely at customer's own risk, and (c) customer fully indemnifies NXP Semiconductors for any liability, damages or failed product claims resulting from customer design and use of the product for automotive applications beyond NXP Semiconductors' standard warranty and NXP Semiconductors' product specifications.

## 15.4 Trademarks

Notice: All referenced brands, product names, service names and trademarks are the property of their respective owners.

## 16. Contact information

For more information, please visit: <http://www.nxp.com>

For sales office addresses, please send an email to: [salesaddresses@nxp.com](mailto:salesaddresses@nxp.com)



## 17. Contents

<b>1</b>	<b>General description</b> . . . . .	<b>1</b>	<b>12</b>	<b>Package outline</b> . . . . .	<b>28</b>
<b>2</b>	<b>Features and benefits</b> . . . . .	<b>1</b>	<b>13</b>	<b>Abbreviations</b> . . . . .	<b>29</b>
2.1	Half-bridge features . . . . .	1	<b>14</b>	<b>Revision history</b> . . . . .	<b>30</b>
2.2	Preheat and ignition features . . . . .	1	<b>15</b>	<b>Legal information</b> . . . . .	<b>31</b>
2.3	Lamp boost features . . . . .	1	15.1	Data sheet status . . . . .	31
2.4	Dim features . . . . .	1	15.2	Definitions . . . . .	31
2.5	Protection . . . . .	2	15.3	Disclaimers . . . . .	31
2.6	Other features . . . . .	2	15.4	Trademarks . . . . .	32
<b>3</b>	<b>Applications</b> . . . . .	<b>2</b>	<b>16</b>	<b>Contact information</b> . . . . .	<b>32</b>
<b>4</b>	<b>Ordering information</b> . . . . .	<b>2</b>	<b>17</b>	<b>Contents</b> . . . . .	<b>33</b>
<b>5</b>	<b>Block diagram</b> . . . . .	<b>3</b>			
<b>6</b>	<b>Pinning information</b> . . . . .	<b>4</b>			
6.1	Pinning . . . . .	4			
6.2	Pin description . . . . .	4			
<b>7</b>	<b>Functional description</b> . . . . .	<b>5</b>			
7.1	Lamp start-up cycle . . . . .	6			
7.1.1	Reset state . . . . .	6			
7.1.2	Start-up state . . . . .	6			
7.1.3	Preheat state . . . . .	6			
7.1.4	Ignition state . . . . .	7			
7.1.5	Boost state and transition to burn state . . . . .	8			
7.1.6	Burn state . . . . .	9			
7.1.7	Hold state . . . . .	10			
7.2	Oscillation and timing . . . . .	11			
7.2.1	Oscillation . . . . .	11			
7.2.2	Combined timing circuit . . . . .	12			
7.3	Natural linear dimming . . . . .	13			
7.4	Protection and power-down . . . . .	14			
7.4.1	Coil saturation protection . . . . .	14			
7.4.2	OverCurrent Protection (OCP) . . . . .	15			
7.4.3	OverPower Protection (OPP) . . . . .	15			
7.4.4	Capacitive Mode Protection (CMP) . . . . .	15			
7.4.5	Power-down mode . . . . .	16			
7.4.6	OverTemperature Protection (OTP) . . . . .	16			
<b>8</b>	<b>Limiting values</b> . . . . .	<b>17</b>			
<b>9</b>	<b>Thermal characteristics</b> . . . . .	<b>18</b>			
<b>10</b>	<b>Characteristics</b> . . . . .	<b>18</b>			
<b>11</b>	<b>Application information</b> . . . . .	<b>24</b>			
11.1	Design equations . . . . .	24			
11.1.1	$C_{CP}$ related timing equations: . . . . .	24			
11.1.2	$C_{CB}$ related timing equations: . . . . .	24			
11.1.3	$C_{CF}$ related frequency equations: . . . . .	24			
11.1.4	$R_{SLS}$ related preheat current: . . . . .	25			
11.1.5	$R_{MDL}$ related MDL: . . . . .	25			
11.1.6	$R_{LSAT}$ related saturation and overcurrent threshold level . . . . .	25			

Please be aware that important notices concerning this document and the product(s) described herein, have been included in section 'Legal information'.

© NXP B.V. 2011.

All rights reserved.

For more information, please visit: <http://www.nxp.com>

For sales office addresses, please send an email to: [salesaddresses@nxp.com](mailto:salesaddresses@nxp.com)

Date of release: 12 October 2011

Document identifier: UBA20271\_UBA20272