

## TLPGE19TP(F), TLFGE19TP(F), TLGE19TP(F), TLPYE19TP(F)

### Panel Circuit Indicator

Unit: mm

- Lead(Pb)-free products (lead: Sn-Ag-Cu)
- 5 mm package
- InGaAlP technology
- All plastic mold type
- Transparent lens
- Lineup: 3colors (pure green, green, pure yellow)
- High intensity light emission
- Excellent low current light output
- Applications: Traffic signals, Safety equipment, Backlight
- Stopper lead type is also available  
TLPGE19T(F), TLFGE19T(F), TLGE19T(F), TLPYE19T(F)

### Lineup

| Product Name | Color       | Material |
|--------------|-------------|----------|
| TLPGE19TP(F) | Pure Green  | InGaAlP  |
| TLFGE19TP(F) | Green       |          |
| TLGE19TP(F)  | Green       |          |
| TLPYE19TP(F) | Pure Yellow |          |

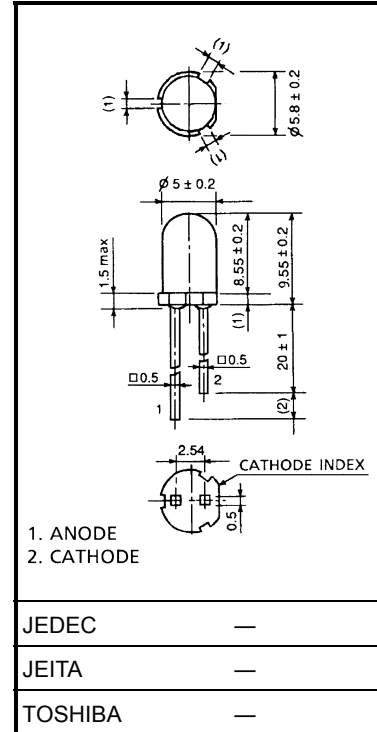

Weight: 0.31 g

### Maximum Ratings (Ta = 25°C)

| Product Name | Forward Current<br>I <sub>F</sub> (mA) | Reverse Voltage<br>V <sub>R</sub> (V) | Power Dissipation<br>P <sub>D</sub> (mW) | Operating Temperature<br>T <sub>opr</sub> (°C) | Storage Temperature<br>T <sub>stg</sub> (°C) |
|--------------|--|---------------------------------------|--|--|--|
| TLPGE19TP(F) | 50                                     | 4                                     | 120                                      | -40~100  | -40~120                                      |
| TLFGE19TP(F) | 50                                     | 4                                     | 120                                      |  |  |
| TLGE19TP(F)  | 50                                     | 4                                     | 120                                      |  |  |
| TLPYE19TP(F) | 50                                     | 4                                     | 120                                      |  |  |



For part availability and ordering information please call Toll Free: 800.984.5337  
Website: [www.marktechopto.com](http://www.marktechopto.com) | Email: [info@marktechopto.com](mailto:info@marktechopto.com)

# TOSHIBA TLPGE19TP(F), TLFGE19TP(F), TLGE19TP(F), TLPYE19TP(F)

## Electrical and Optical Characteristics (Ta = 25°C)

| Product Name | Typ. Emission Wavelength |                |    |                | Luminous Intensity<br>I <sub>V</sub> |      |                | Forward Voltage<br>V <sub>F</sub> |     |                | Reverse Current<br>I <sub>R</sub> |                |
|--------------|--------------------------|----------------|----|----------------|--------------------------------------|------|----------------|-----------------------------------|-----|----------------|-----------------------------------|----------------|
|              | λ <sub>d</sub>           | λ <sub>p</sub> | Δλ | I <sub>F</sub> | Min                                  | Typ. | I <sub>F</sub> | Typ.                              | Max | I <sub>F</sub> | Max                               | V <sub>R</sub> |
| TLPGE19TP(F) | 558                      | (562)          | 14 | 20             | 153                                  | 500  | 20             | 2.1                               | 2.4 | 20             | 50                                | 4              |
| TLFGE19TP(F) | 565                      | (568)          | 15 | 20             | 272                                  | 800  | 20             | 2.0                               | 2.4 | 20             | 50                                | 4              |
| TLGE19TP(F)  | 571                      | (574)          | 17 | 20             | 476                                  | 1300 | 20             | 2.0                               | 2.4 | 20             | 50                                | 4              |
| TLPYE19TP(F) | 580                      | (583)          | 14 | 20             | 476                                  | 2000 | 20             | 2.0                               | 2.4 | 20             | 50                                | 4              |
| Unit         | nm                       |                |    | mA             | mcd                                  |      | mA             | V                                 |     | mA             | μA                                | V              |

## Precautions

Please be careful of the following:

- Soldering temperature: 260°C max, soldering time: 3 s max  
(soldering portion of lead: up to 2 mm from the body of the device)
- If the lead is formed, the lead should be formed up to 5 mm from the body of the device without forming stress to the resin. Soldering should be performed after lead forming.
- This visible LED lamp also emits some IR light.  
If a photodetector is located near the LED lamp, please ensure that it will not be affected by this IR light.

## TLPGE19TP(F)

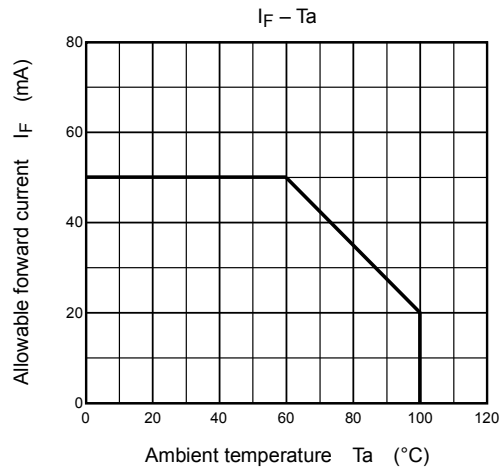
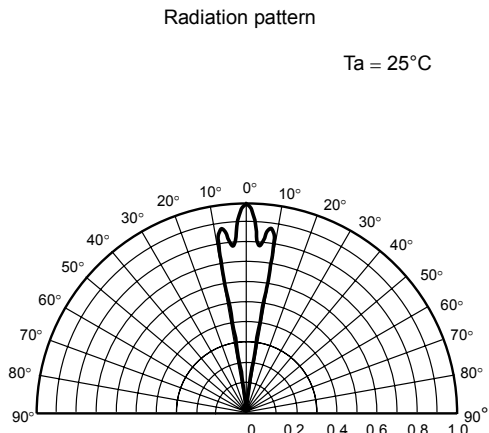
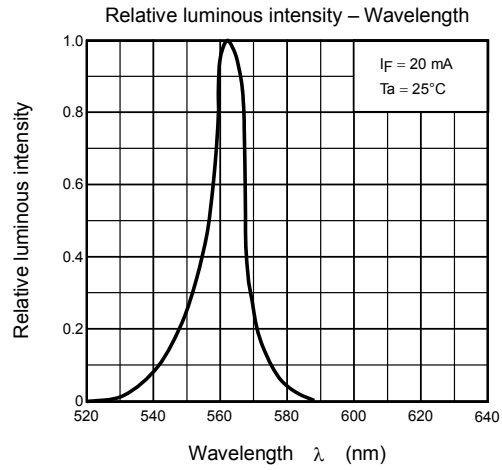
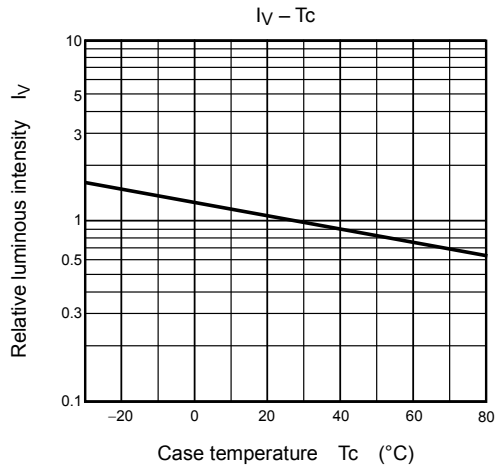
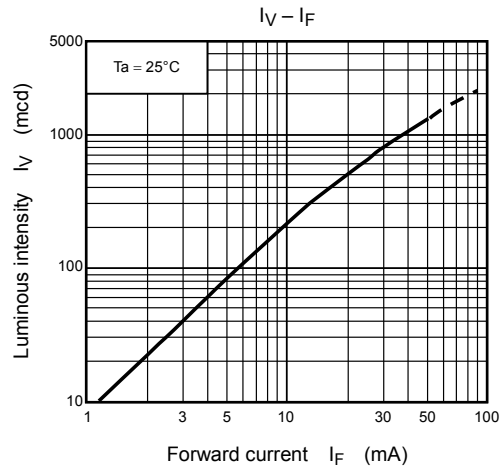
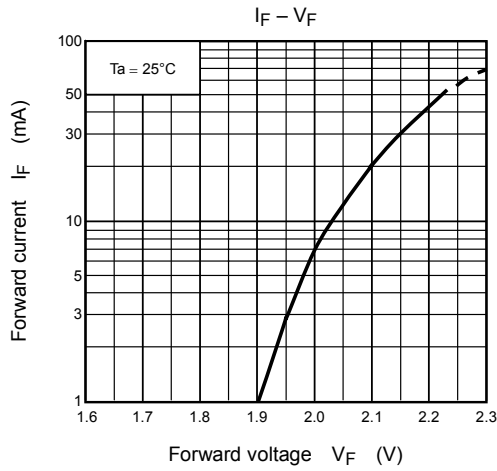

## TLFGE19TP(F)

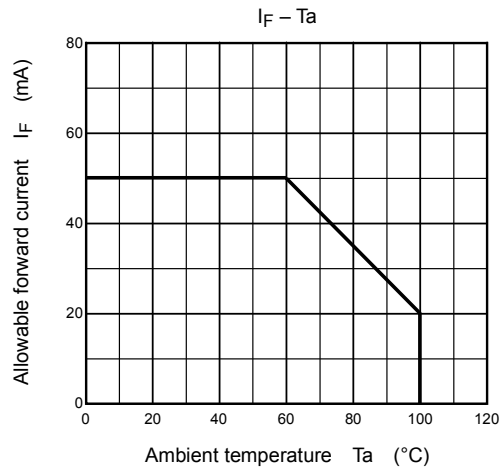
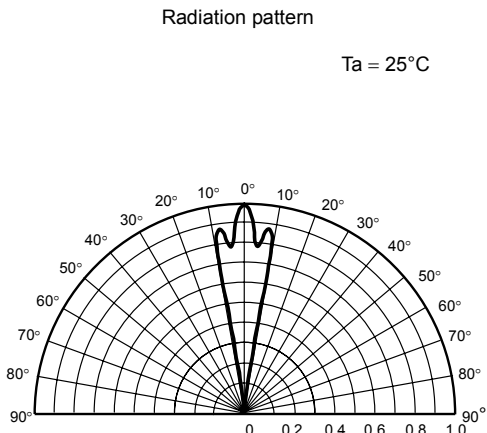
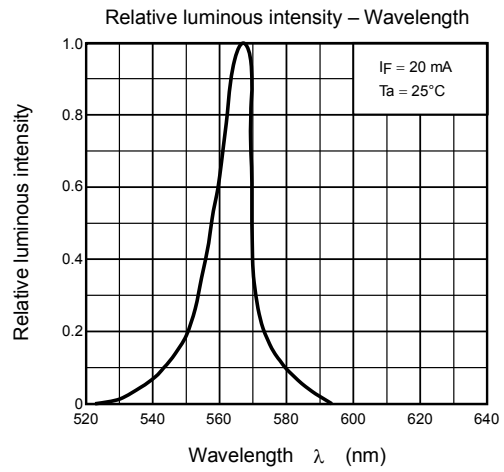
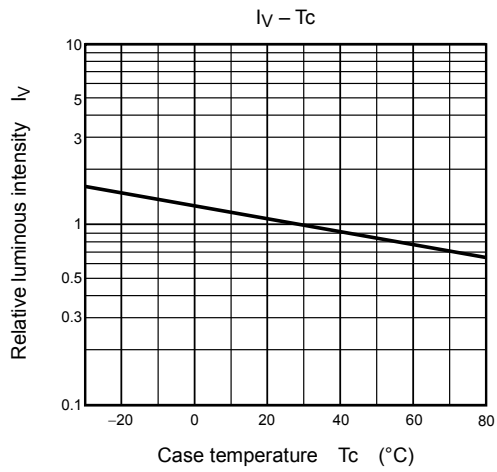
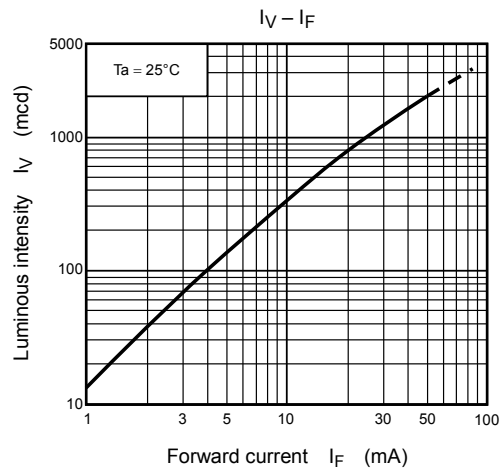
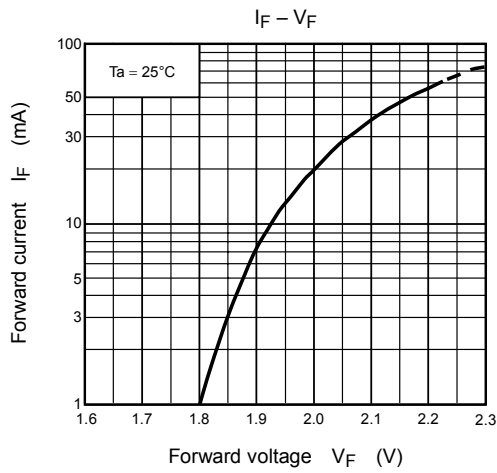

**TLGE19TP(F)**

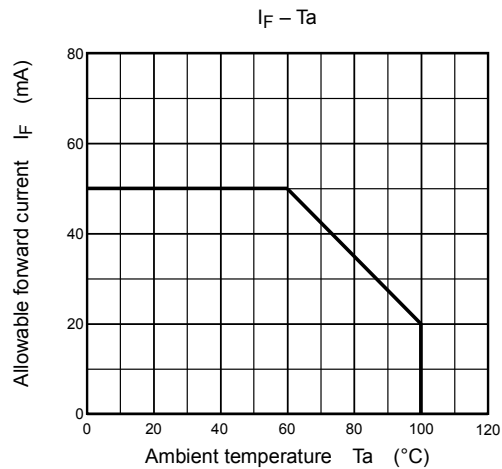
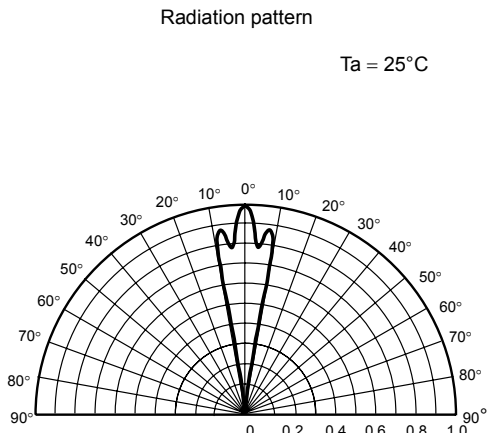
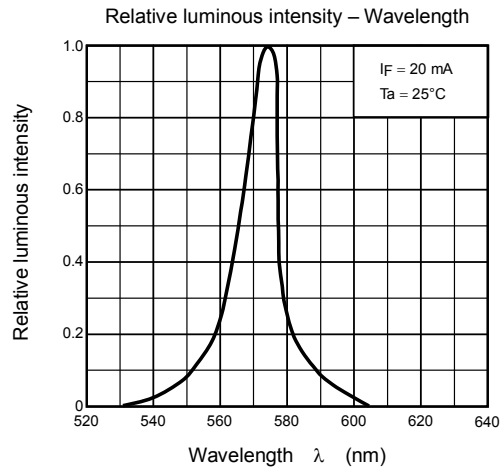
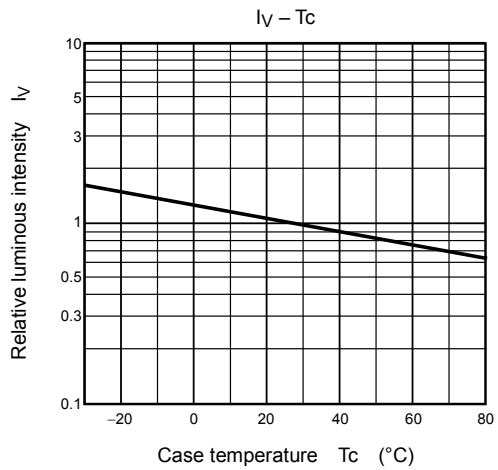
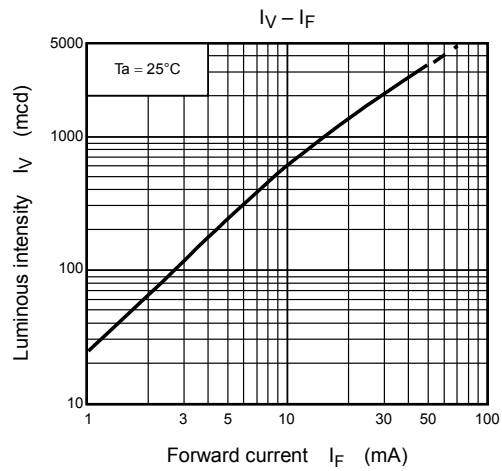
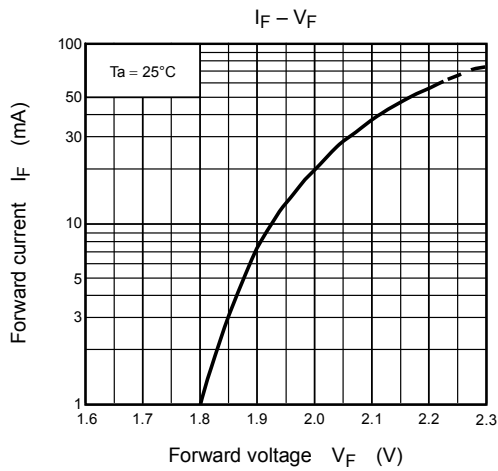

**TLPYE19TP(F)**

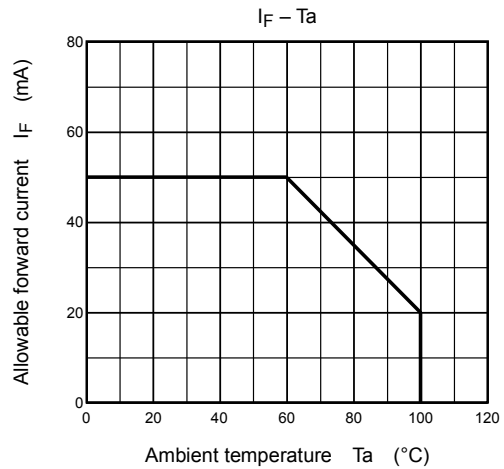
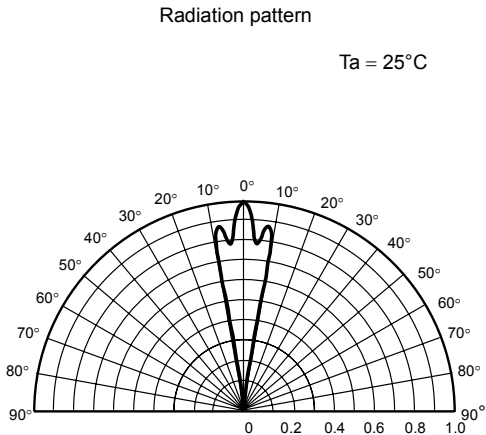
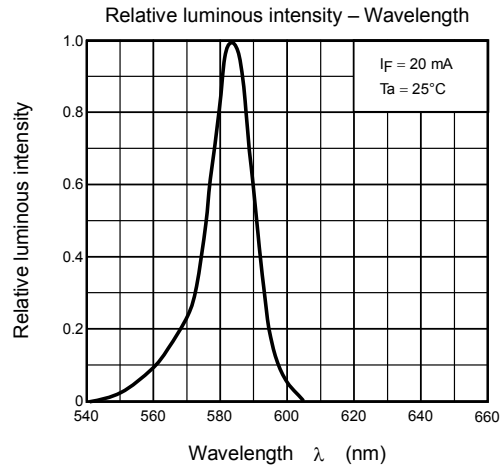
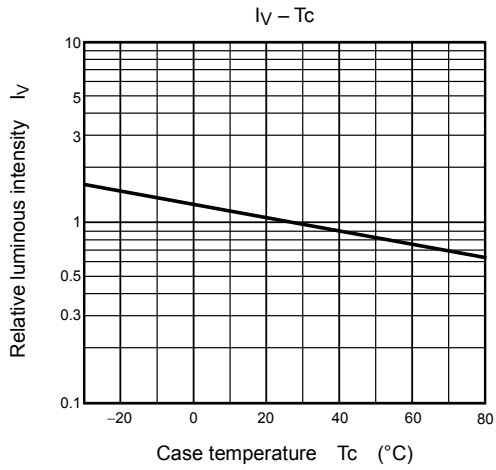
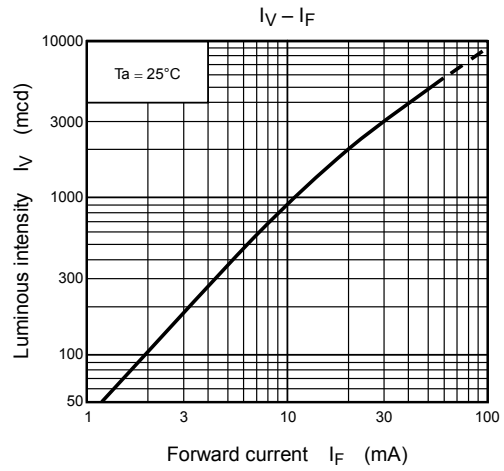
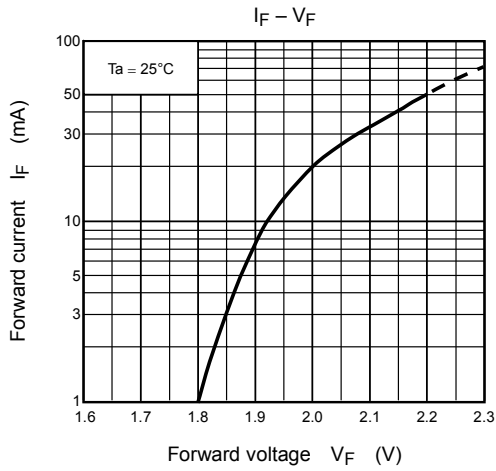

## **RESTRICTIONS ON PRODUCT USE**

030619EAC

- The information contained herein is subject to change without notice.
- The information contained herein is presented only as a guide for the applications of our products. No responsibility is assumed by TOSHIBA for any infringements of patents or other rights of the third parties which may result from its use. No license is granted by implication or otherwise under any patent or patent rights of TOSHIBA or others.
- TOSHIBA is continually working to improve the quality and reliability of its products. Nevertheless, semiconductor devices in general can malfunction or fail due to their inherent electrical sensitivity and vulnerability to physical stress. It is the responsibility of the buyer, when utilizing TOSHIBA products, to comply with the standards of safety in making a safe design for the entire system, and to avoid situations in which a malfunction or failure of such TOSHIBA products could cause loss of human life, bodily injury or damage to property.  
In developing your designs, please ensure that TOSHIBA products are used within specified operating ranges as set forth in the most recent TOSHIBA products specifications. Also, please keep in mind the precautions and conditions set forth in the "Handling Guide for Semiconductor Devices," or "TOSHIBA Semiconductor Reliability Handbook" etc..
- The TOSHIBA products listed in this document are intended for usage in general electronics applications (computer, personal equipment, office equipment, measuring equipment, industrial robotics, domestic appliances, etc.). These TOSHIBA products are neither intended nor warranted for usage in equipment that requires extraordinarily high quality and/or reliability or a malfunction or failure of which may cause loss of human life or bodily injury ("Unintended Usage"). Unintended Usage include atomic energy control instruments, airplane or spaceship instruments, transportation instruments, traffic signal instruments, combustion control instruments, medical instruments, all types of safety devices, etc.. Unintended Usage of TOSHIBA products listed in this document shall be made at the customer's own risk.
- TOSHIBA products should not be embedded to the downstream products which are prohibited to be produced and sold, under any law and regulations.
- GaAs(Gallium Arsenide) is used in this product. The dust or vapor is harmful to the human body. Do not break, cut, crush or dissolve chemically.