



STN851

LOW VOLTAGE FAST-SWITCHING NPN POWER TRANSISTOR

PRELIMINARY DATA

Ordering Code	Marking	Shipment
STN851	N851	Tape & Reel

- VERY LOW COLLECTOR TO EMITTER SATURATION VOLTAGE
- HIGH CURRENT GAIN CHARACTERISTIC
- FAST-SWITCHING SPEED
- SURFACE-MOUNTING SOT-223 MEDIUM POWER PACKAGE IN TAPE & REEL

APPLICATIONS:

- EMERGENCY LIGHTING
- VOLTAGE REGULATORS
- RELAY DRIVERS
- HIGH EFFICIENCY LOW VOLTAGE SWITCHING APPLICATIONS

DESCRIPTION

The device is manufactured in NPN Planar Technology by using a "Base Island" layout. The resulting Transistor shows exceptional high gain performance coupled with very low saturation voltage.

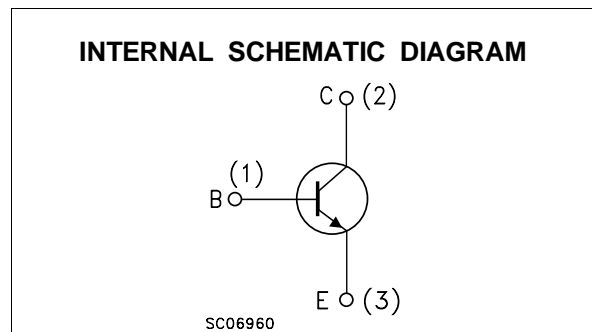
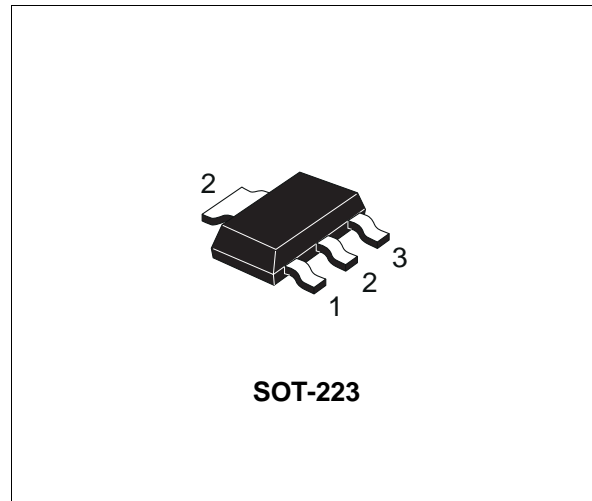

ABSOLUTE MAXIMUM RATINGS

Symbol	Parameter	Value	Unit
V_{CBO}	Collector-Base Voltage ($I_E = 0$)	150	V
V_{CEO}	Collector-Emitter Voltage ($I_B = 0$)	60	V
V_{EBO}	Emitter-Base Voltage ($I_C = 0$)	7	V
I_C	Collector Current	5	A
I_{CM}	Collector Peak Current ($t_p < 5$ ms)	10	A
I_B	Base Current	1	A
I_{BM}	Base Peak Current ($t_p < 5$ ms)	2	A
P_{tot}	Total Dissipation at $T_{amb} = 25$ °C	1.6	W
T_{stg}	Storage Temperature	-65 to 150	°C
T_j	Max. Operating Junction Temperature	150	°C

THERMAL DATA

$R_{thj-amb}$	Thermal Resistance Junction-ambient	Max	78	$^{\circ}\text{C}/\text{W}$
---------------	-------------------------------------	-----	----	-----------------------------

• Device mounted on a P.C.B. area of 1 cm^2

ELECTRICAL CHARACTERISTICS ($T_{case} = 25\text{ }^{\circ}\text{C}$ unless otherwise specified)

Symbol	Parameter	Test Conditions	Min.	Typ.	Max.	Unit
I_{CBO}	Collector Cut-off Current ($I_E = 0$)	$V_{CB} = 120\text{ V}$ $V_{CB} = 120\text{ V}$ $T_j = 100\text{ }^{\circ}\text{C}$			50 1	nA μA
I_{EBO}	Emitter Cut-off Current ($I_C = 0$)	$V_{EB} = 7\text{ V}$			10	nA
$V_{(BR)CBO}$	Collector-Base Breakdown Voltage ($I_E = 0$)	$I_C = 100\text{ }\mu\text{A}$	150			V
$V_{(BR)CEO}^*$	Collector-Emitter Breakdown Voltage ($I_B = 0$)	$I_C = 10\text{ mA}$	60			V
$V_{(BR)EBO}$	Emitter-Base Breakdown Voltage ($I_C = 0$)	$I_E = 100\text{ }\mu\text{A}$	7			V
$V_{CE(sat)}^*$	Collector-Emitter Saturation Voltage	$I_C = 100\text{ mA}$ $I_B = 5\text{ mA}$ $I_C = 1\text{ A}$ $I_B = 50\text{ mA}$ $I_C = 2\text{ A}$ $I_B = 50\text{ mA}$ $I_C = 5\text{ A}$ $I_B = 200\text{ mA}$		10 70 140 320	50 120 250 500	mV mV mV mV
$V_{BE(sat)}^*$	Base-Emitter Saturation Voltage	$I_C = 4\text{ A}$ $I_B = 200\text{ mA}$		1	1.15	V
$V_{BE(on)}^*$	Base-Emitter On Voltage	$I_C = 4\text{ A}$ $V_{CE} = 1\text{ V}$		0.89	1	V
h_{FE}^*	DC Current Gain	$I_C = 10\text{ mA}$ $V_{CE} = 1\text{ V}$ $I_C = 2\text{ A}$ $V_{CE} = 1\text{ V}$ $I_C = 5\text{ A}$ $V_{CE} = 1\text{ V}$ $I_C = 10\text{ A}$ $V_{CE} = 1\text{ V}$	150 150 90 30	300 270 140 50	350	
f_T	Transition frequency	$V_{CE} = 10\text{ V}$ $I_C = 100\text{ mA}$		130		MHz
C_{CBO}	Collector-Base Capacitance	$V_{CB} = 10\text{ V}$ $f = 1\text{ MHz}$		50		pF
t_{on} t_s t_f	RESISTIVE LOAD Turn- on Time Storage Time Fall Time	$I_C = 1\text{ A}$ $V_{CC} = 10\text{ V}$ $I_{B1} = - I_{B2} = 0.1\text{ A}$		50 1.35 120		ns μs ns

* Pulsed: Pulse duration = $300\mu\text{s}$, duty cycle = 1.5 %

Derating Curve



DC Current Gain

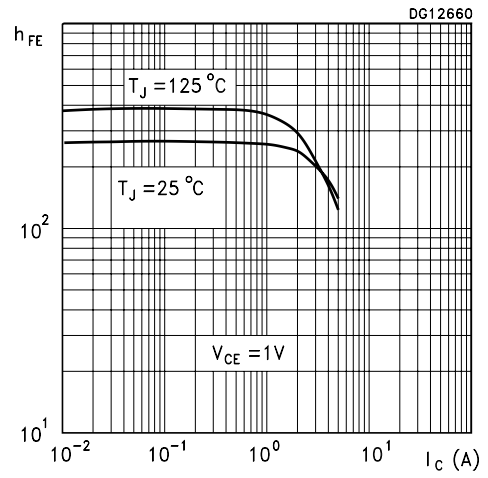

Collector-Emitter Saturation Voltage

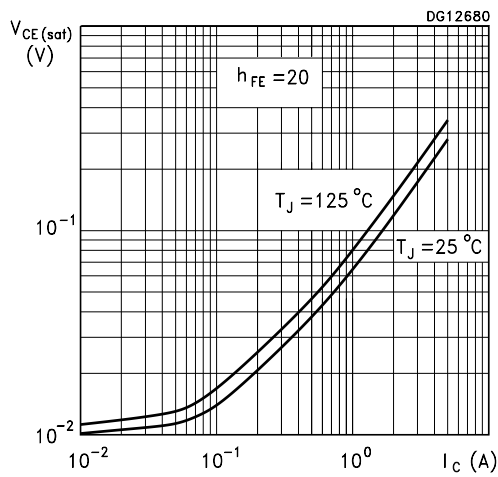

Collector-Emitter Saturation Voltage

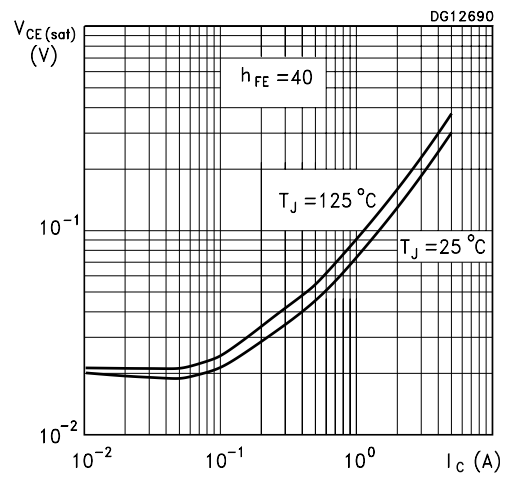

Base-Emitter Saturation Voltage

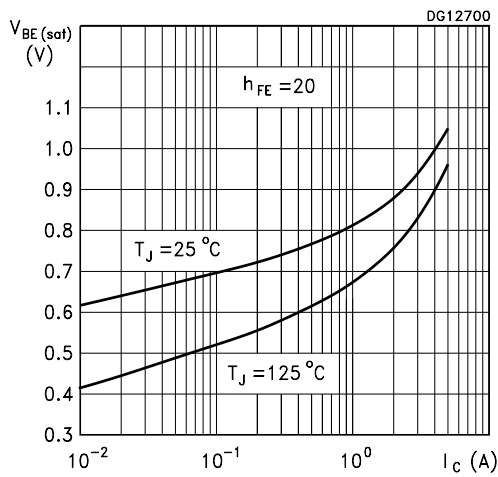

Base-Emitter On Voltage

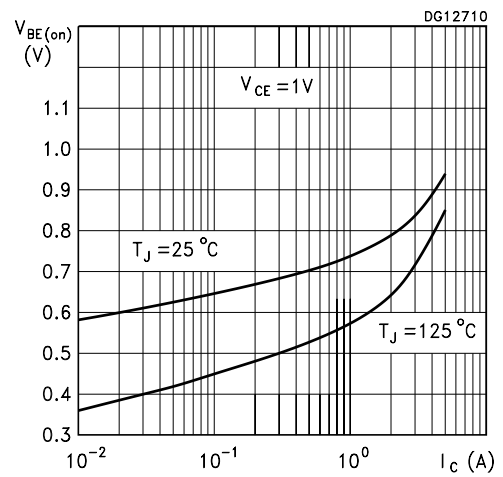

Switching Times Resistive Load

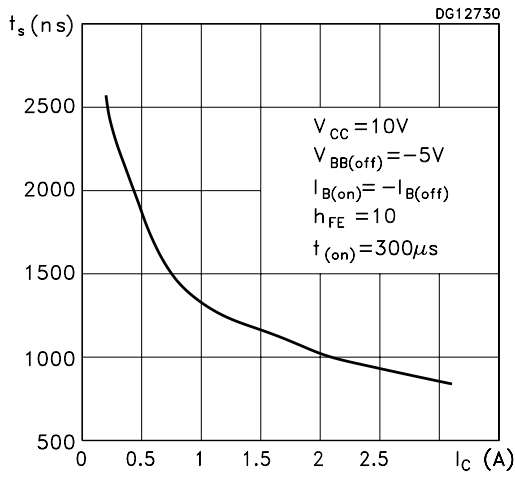

Switching Times Resistive Load

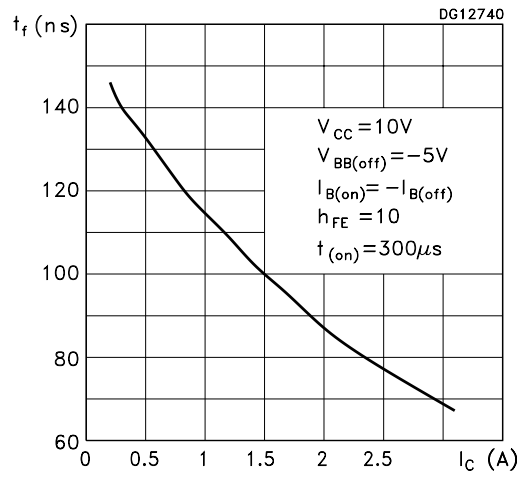

Switching Times Resistive Load

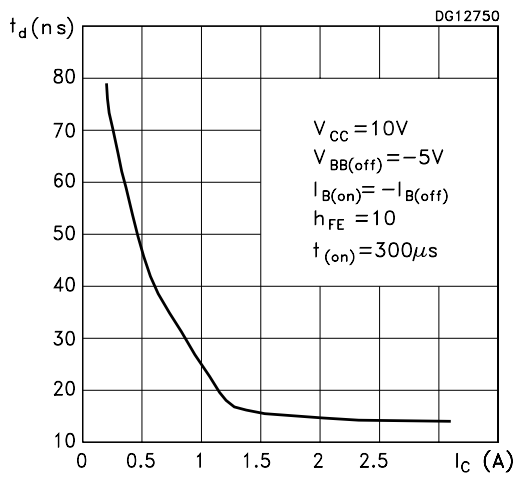

Switching Times Inductive Load

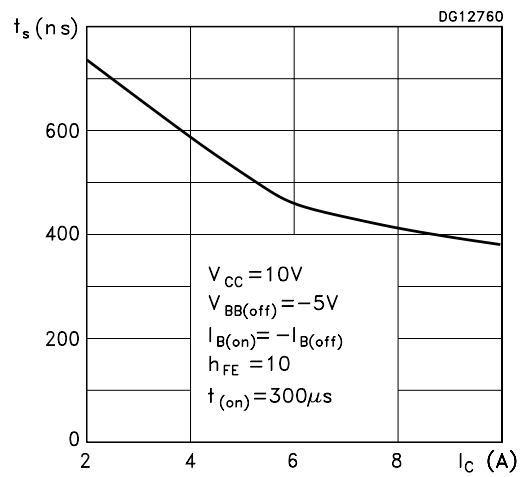

Switching Times Inductive Load

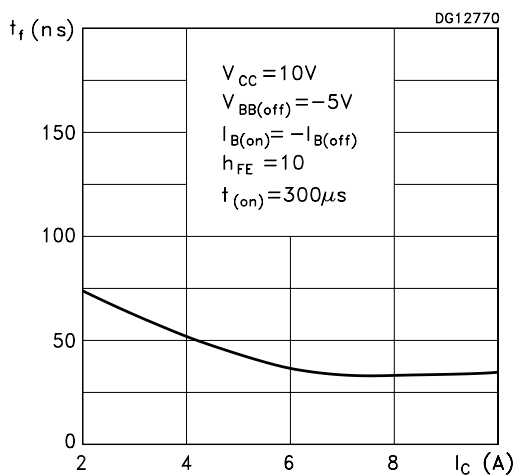
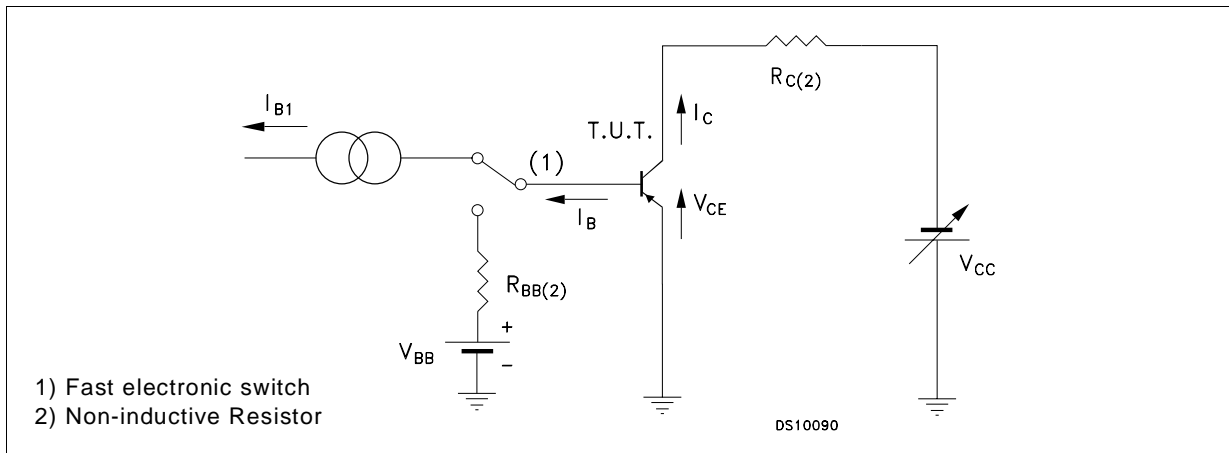
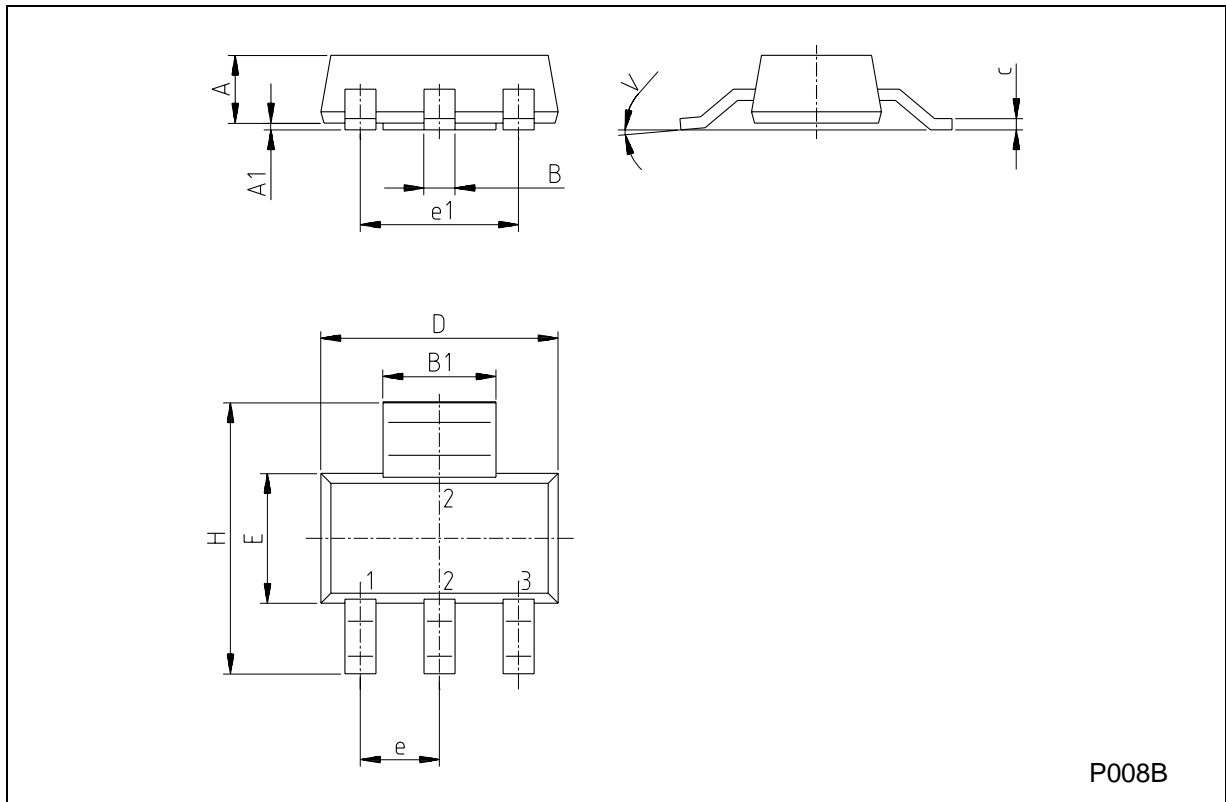

Figure 1: Resistive Load Switching Test Circuit.

SOT-223 MECHANICAL DATA

DIM.	mm			inch		
	MIN.	TYP.	MAX.	MIN.	TYP.	MAX.
A			1.80			0.071
B	0.60	0.70	0.80	0.024	0.027	0.031
B1	2.90	3.00	3.10	0.114	0.118	0.122
c	0.24	0.26	0.32	0.009	0.010	0.013
D	6.30	6.50	6.70	0.248	0.256	0.264
e		2.30			0.090	
e1		4.60			0.181	
E	3.30	3.50	3.70	0.130	0.138	0.146
H	6.70	7.00	7.30	0.264	0.276	0.287
V			10°			10°
A1		0.02				



Information furnished is believed to be accurate and reliable. However, STMicroelectronics assumes no responsibility for the consequences of use of such information nor for any infringement of patents or other rights of third parties which may result from its use. No license is granted by implication or otherwise under any patent or patent rights of STMicroelectronics. Specification mentioned in this publication are subject to change without notice. This publication supersedes and replaces all information previously supplied. STMicroelectronics products are not authorized for use as critical components in life support devices or systems without express written approval of STMicroelectronics.

The ST logo is a trademark of STMicroelectronics.

All other names are the property of their respective owners.

© 2003 STMicroelectronics – All Rights reserved

STMicroelectronics GROUP OF COMPANIES

Australia - Belgium - Brazil - Canada - China - Czech Republic - Finland - France - Germany - Hong Kong - India - Israel - Italy - Japan - Malaysia - Malta - Morocco - Singapore - Spain - Sweden - Switzerland - United Kingdom - United States.

<http://www.st.com>