

Dual P-channel MOSFET

ELM18807BA-S

■ General description

ELM18807BA-S uses advanced trench technology to provide excellent $R_{ds(on)}$ and low gate charge. Internal ESD protection is included.

■ Features

- $V_{ds} = -12V$
- $I_d = -6.5A$ ($V_{gs} = -4.5V$)
- $R_{ds(on)} < 20m\Omega$ ($V_{gs} = -4.5V$)
- $R_{ds(on)} < 24m\Omega$ ($V_{gs} = -2.5V$)
- $R_{ds(on)} < 30m\Omega$ ($V_{gs} = -1.8V$)
- $R_{ds(on)} < 36m\Omega$ ($V_{gs} = -1.5V$)
- ESD Protected

■ Maximum absolute ratings

Parameter	Symbol	Limit	Unit	Note
Drain-source voltage	V_{ds}	-12	V	
Gate-source voltage	V_{gs}	± 8	V	
Continuous drain current	I_d	$T_a = 25^\circ C$	-6.5	A
		$T_a = 70^\circ C$	-5.0	
Pulsed drain current	I_{dm}	-60	A	3
Power dissipation	P_d	$T_a = 25^\circ C$	1.4	W
		$T_a = 70^\circ C$	0.9	
Junction and storage temperature range	T_j, T_{stg}	-55 to 150	$^\circ C$	

■ Thermal characteristics

Parameter		Symbol	Typ.	Max.	Unit	Note
Maximum junction-to-ambient	$t \leq 10s$	$R_{\theta ja}$	73	90	$^\circ C/W$	1
Maximum junction-to-ambient	Steady-state		96	125	$^\circ C/W$	1, 4
Maximum junction-to-lead	Steady-state	$R_{\theta jl}$	63	75	$^\circ C/W$	

■ Pin configuration

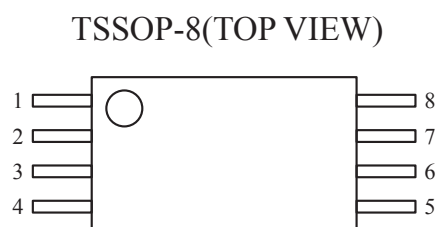

Pin No.	Pin name	Pin No.	Pin name
1	DRAIN1	5	GATE2
2	SOURCE1	6	SOURCE2
3	SOURCE1	7	SOURCE2
4	GATE1	8	DRAIN2

■ Circuit

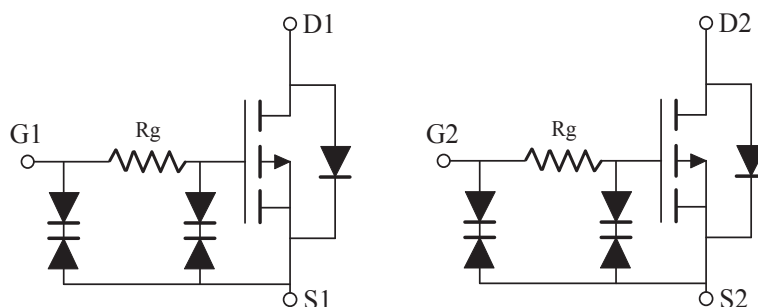

Dual P-channel MOSFET

ELM18807BA-S

■ Electrical characteristics

Ta=25°C

Parameter	Symbol	Condition	Min.	Typ.	Max.	Unit
STATIC PARAMETERS						
Drain-source breakdown voltage	BVdss	Id=-250μA, Vgs=0V	-12			V
Zero gate voltage drain current	Idss	Vds=-12V, Vgs=0V Tj=55°C			-1	μA
					-5	
Gate-body leakage current	Igss	Vds=0V, Vgs=±8V			±10	μA
Gate threshold voltage	Vgs(th)	Vds=Vgs, Id=-250μA	-0.35	-0.53	-0.85	V
On state drain current	Id(on)	Vgs=-4.5V, Vds=-5V	-60			A
Static drain-source on-resistance	Rds(on)	Vgs=-4.5V Id=-6.5A Tj=125°C		16	20	mΩ
				23	28	
		Vgs=-2.5V, Id=-6A		19	24	
		Vgs=-1.8V, Id=-5.5A		23	30	
		Vgs=-1.5V, Id=-5A		28	36	
Forward transconductance	Gfs	Vds=-5V, Id=-6.5A		45		S
Diode forward voltage	Vsd	Is=-1A, Vgs=0V		-0.56	-1.00	V
Max. body-diode continuous current	Is				-1.4	A
DYNAMIC PARAMETERS						
Input capacitance	Ciss	Vgs=0V, Vds=-6V, f=1MHz		1740	2100	pF
Output capacitance	Coss			334		pF
Reverse transfer capacitance	Crss			200		pF
Gate resistance	Rg	Vgs=0V, Vds=0V, f=1MHz		1.3	1.7	kΩ
SWITCHING PARAMETERS						
Total gate charge	Qg	Vgs=-4.5V, Vds=-6V, Id=-6.5A		19.0	23.0	nC
Gate-source charge	Qgs			4.5		nC
Gate-drain charge	Qgd			5.3		nC
Turn-on delay time	td(on)	Vgs=-4.5V, Vds=-6V RL=0.9Ω, Rgen=3Ω		240.0		ns
Turn-on rise time	tr			580.0		ns
Turn-off delay time	td(off)			7.0		ns
Turn-off fall time	tf			4.2		ns
Body diode reverse recovery time	trr	If=-6.5A, dl/dt=100A/μs		22	27	ns
Body diode reverse recovery charge	Qrr	If=-6.5A, dl/dt=100A/μs		17		nC

NOTE :

1. The value of Rθja is measured with the device mounted on 1in² FR-4 board with 2oz. Copper, in still air environment with Ta=25°C. The value in any given applications depends on the user's specific board design.
2. The power dissipation Pd is based on Tj(Max.)=150°C, using ≤ 10s junction-to-ambient thermal resistance.
3. Repetitive rating, pulse width limited by junction temperature Tj(Max.)=150°C. Ratings are based on low frequency and duty cycles to keep initial Tj=25°C.
4. The Rθja is the sum of the thermal impedance from junction to lead Rθjl and lead to ambient.
5. The static characteristics in Figures 1 to 6 are obtained using <300μs pulses, duty cycle 0.5% max.
6. These curves are based on the junction-to-ambient thermal impedance which is measured with the device mounted on 1in² FR-4 board with 2oz. Copper, assuming a maximum junction temperature of Tj(Max.)=150°C. The SOA curve provides a single pulse rating.

Dual P-channel MOSFET

ELM18807BA-S

■ Typical electrical and thermal characteristics

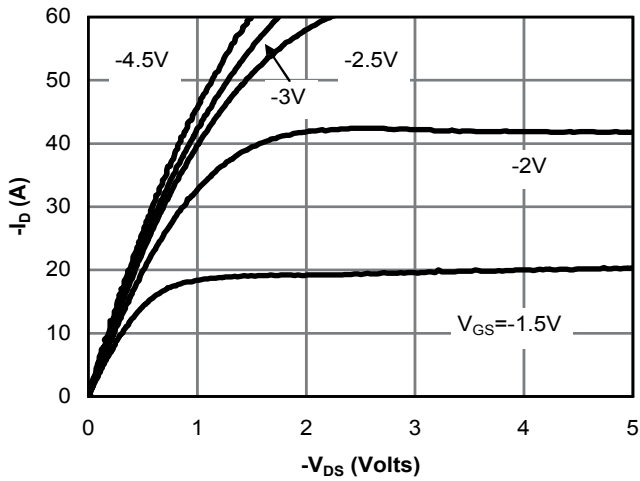

Figure 1: On-Region Characteristics(Note E)

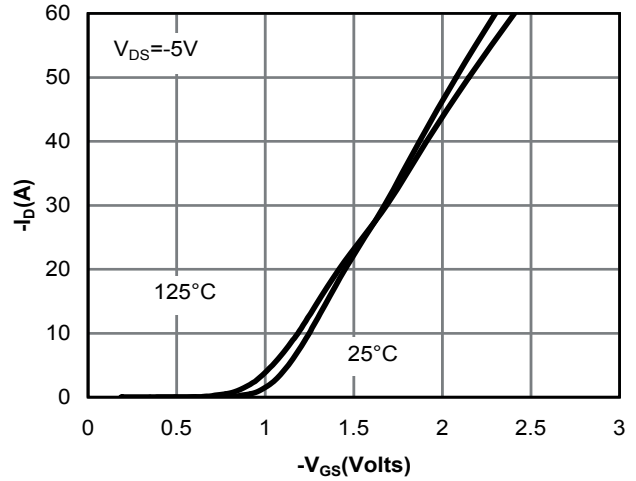

Figure 2: Transfer Characteristics(Note E)

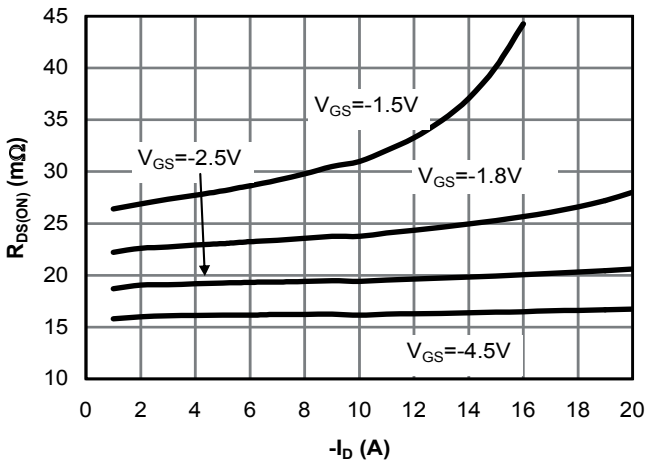

Figure 3: On-Resistance vs. Drain Current and Gate Voltage(Note E)

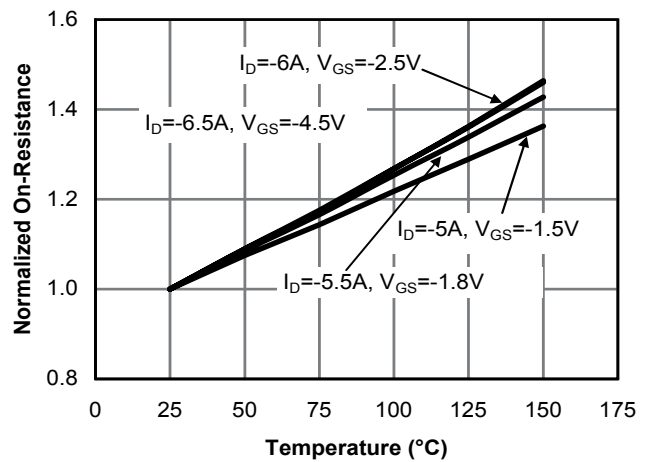

Figure 4: On-Resistance vs. Junction Temperature(Note E)

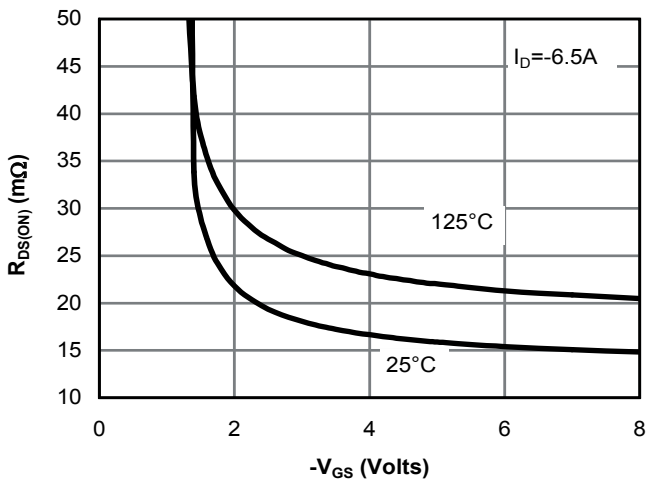

Figure 5: On-Resistance vs. Gate-Source Voltage(Note E)

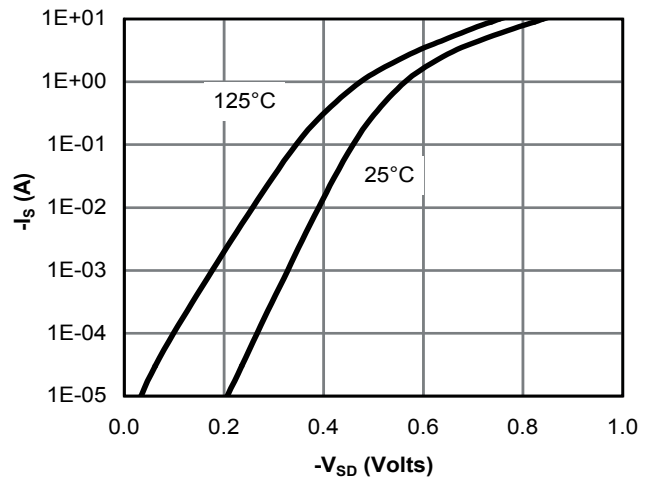

Figure 6: Body-Diode Characteristics(Note E)

Dual P-channel MOSFET

ELM18807BA-S

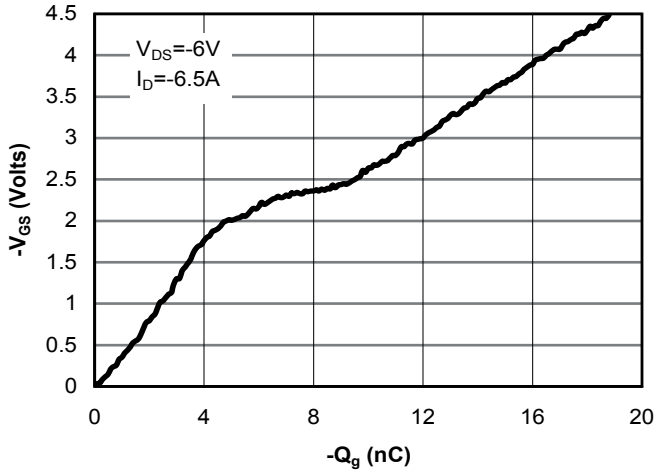

Figure 7: Gate-Charge Characteristics

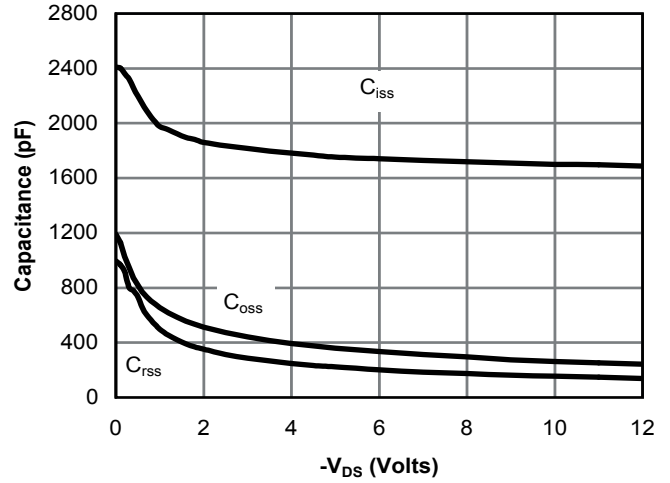

Figure 8: Capacitance Characteristics

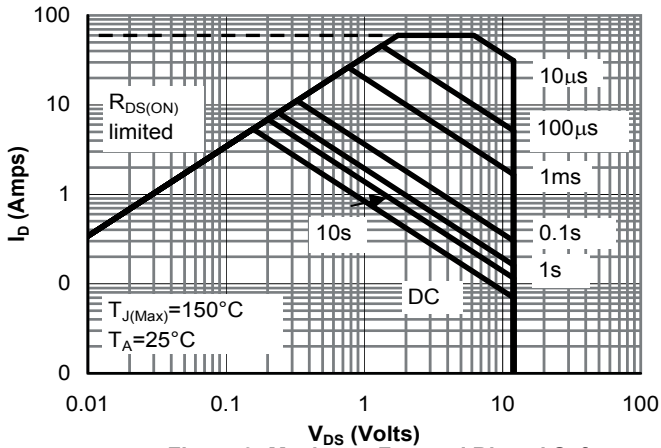

Figure 9: Maximum Forward Biased Safe Operating Area (Note F)

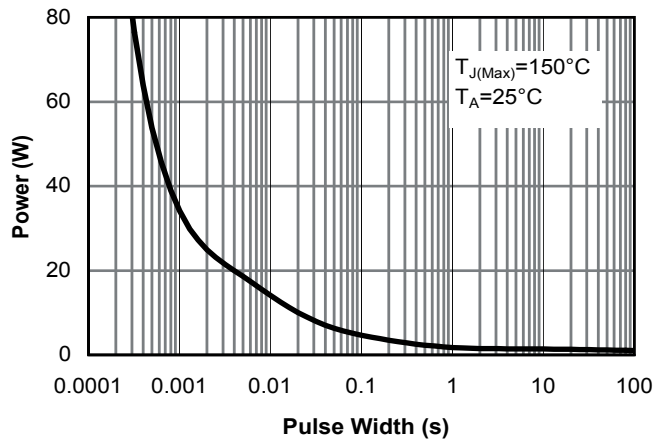

Figure 10: Single Pulse Power Rating Junction-to-Ambient (Note F)

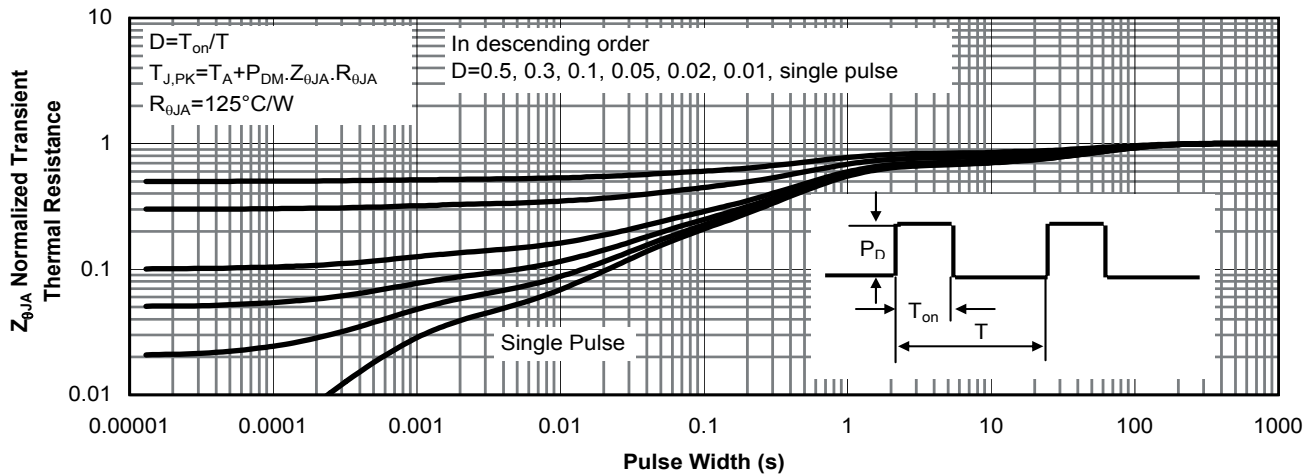

Figure 11: Normalized Maximum Transient Thermal Impedance (Note F)